

ISO 9001
CERTIFIED



Dura-Bond®

A MELLING COMPANY

CAMSHAFT BEARINGS · FULL ROUND · O.H.C. HALF SHELL · HIGH PERFORMANCE · TOOLS · VALVE SEAT INSERTS · VALVE SPRING BOOSTER SHIMS · ENGINE HARDWARE · ENGINE HARDWARE FINISHING KITS



2014 CATALOG

Camshaft Bearing, Bushing, Valve Seat, Valve Spring Shim, Hardware *manufacturer.*

Engineering Solutions Partner.



Dura-Bond Bearing Company is a world leader in camshaft bearings, powder metal valve seats and valve spring shim design and manufacturing. This has been recognized by over 60 years of experience as the standard of the industry, and the internationally recognized ISO9001 and MRP – Oliver Wight Class "A" certifications.

The natural process of matching complimentary valve train components provides solutions that are designed as a system, not as only individual components.

CAM BEARINGS/BUSHINGS – The seamless, 100% machined surface design provides the tightest tolerances in the industry. The centerless ground OD, centerless bored ID results in wall variations of .0004 in., giving the customer increased system design flexibility. Discrete manufacturing lines can supply both high and low volumes economically. We can be a valued strategic partner with our design, development and manufacturing capabilities.



Dura-Bond bimetal bearings are constructed of seamless steel tube with a thin layer of lead based babbitt material. Seamless construction makes installation easy, eliminating breakage and bearing surface interruptions.

Lead based babbitt provides ideal properties for nearly all engine applications. Babbitt's superior embedability, conformability, and anti-seizure characteristics have proven to reduce engine failures that harder bearing materials can cause. Dura-Bond Bearing offers:

- **Oversize and undersize bearings for many applications:** Oversize ODs for line bored blocks. Undersized IDs for cam salvage.
- **Semi-finished IDs for line boring requirements:** Unbored IDs allow line boring after bearing installation.
- **OHC repair bearings:** Provides a method to repair aluminum OHC heads. Repairs scored or seized cam/housings and restores cam alignment.
- **High Performance line for racing applications:** Fatigue life of the bearing is nearly doubled with micro-babbitt, chill cast, and burnished construction.
- **Coated High Performance bearings:** Fluoropolymer coated high performance for maximum fatigue life and improved surface properties.
- **Special small run bearings/bushings for prototype or block salvage**

VALVE SEAT INSERTS – Patented materials and processing of these powder metal valve seats offer excellent machinability, along with low wear and high heat resistance. These inserts have finely dispersed tungsten carbide residing in a matrix of tempered tool steel and special alloy iron particles to provide all the properties an application requires. Special compositions and processing have been developed to perform in the most extreme duty applications. Complete in-house capabilities, from development and tooling to testing, reduces lead time and cost.

SHIMS – Valve seat shims and other applications can be supplied in sizes ranging up to 3.00 in. diameter and .060 in. thick, in hardened or annealed condition. Unique tooling design provides short lead times and low economical run quantities.

HARDWARE – The engine tear down and cleaning process can lead to broken, bent, distorted, or lost service parts. These items can be troubling to any engine rebuilder, especially when they are difficult to obtain. That's why Dura-Bond offers many of the hard to find OEM service parts you need at substantially lower prices.



HARDWARE FINISHING KITS – Most rebuilders know the time and expense of trying to reclaim service parts. A recent study revealed that an average rebuilder could spend up to 15-20 minutes per engine searching for a reclaimed service part. That is why Dura-Bond has introduced a new line of engine hardware finishing kits. These kits include all of the necessary hardware and components

needed to complete a rebuild such as dowel pins, cam bolts, seal housing components, woodruff keys, cam eccentrics, by-pass valves, etc. The engine hardware finishing kits allow rebuilders an easy way to inventory and recoup lost costs on these components. All this adds up to saving time and money.



Our customers have come to expect our diverse, high level of service. They know that beyond the manufacture of component parts we are a valued partner in solving problems. From engineering design, to prototype development, sourcing and assembly work... they depend on us as their partner. Our teams of Design, Materials, Application and Manufacturing Engineers are ready to be a part of your team in simultaneous engineering and integration. We would like to work with you, not just as a "production supplier", but as a strategic partner. If your requirements range from prototypes to high volume, let Dura-Bond Bearing Company be part of the solution.

TABLE OF CONTENTS

SECTION	PAGE(S)
1 INTRODUCTION	- I
NEW PART LISTING	1 - 3
2 BEARINGS / BUSHINGS	4 - 5
GENERAL APPLICATION DATA	6 - 60
GENERAL APPLICATION DATA - SPECIALTY AFTERMARKET BLOCKS	59 - 60
BEARING SET CONTENTS	61 - 84
BEARING COMPONENT LISTING	85 - 99
BEARING COMPONENT PROGRESSIVE LISTING BY HOUSING BORE	100 - 114
SPECIALTY BEARING COMPONENT PROGRESSIVE LISTING BY HOUSING BORE	- 115
OPTIMUM PLACEMENT OF CAMSHAFT BEARING OIL FEED HOLE LOCATION DATA	- 116
CONVERSION SIZE CHART	- 117
BEARING COMPETITIVE INTERCHANGES	118 - 126
3 BEARING SYSTEM INSTALLATION TOOLS / ACCESSORIES	
BEARING INSTALLATION TOOL	- 127
ALUMINUM OVERHEAD CAM (OHC) / QUICK BORE SYSTEM	- 128
ALUMINUM OVERHEAD CAM (OHC) ACCESSORIES - BARS, BUSHINGS, AND CUTTERS	129 - 132
4 VALVE SEATS	- 133
VALVE SEAT COMPOSITION	134 - 136
VALVE SEAT NUMERICAL LISTING BY PART NUMBER	137 - 154
VALVE SEAT PROGRESSIVE LISTING BY OUTSIDE DIAMETER	155 - 172
VALVE SEAT PROGRESSIVE LISTING BY INSIDE DIAMETER	173 - 190
"KILLER BEE" COPPER-INFILTRATED VALVE SEATS	191 - 192
UNIVERSAL VALVE SEAT PROGRESSIVE LISTING BY OUTSIDE DIAMETER	- 193
METRIC VALVE SEAT PROGRESSIVE LISTING BY OUTSIDE DIAMETER	194 - 201
VALVE SEAT TECHNICAL AND INSTALLATION INSTRUCTIONS	202 - 211
VALVE SEAT COMPETITIVE INTERCHANGES	212 - 216
5 VALVE SPRING BOOSTER SHIMS	- 217
VALVE SHIM NUMERICAL LISTING BY PART NUMBER	- 218
VALVE SHIM PROGRESSIVE LISTING BY OUTSIDE DIAMETER	- 219
VALVE SHIM PROGRESSIVE LISTING BY INSIDE DIAMETER	- 220
6 ENGINE HARDWARE	221 - 222
GENERAL APPLICATION DATA	223 - 231
ENGINE HARDWARE COMPONENT LISTING	232 - 235
7 ENGINE HARDWARE FINISHING KITS	- 236
GENERAL APPLICATION DATA	237 - 240
8 ENGINE HARDWARE PART PHOTOS	241 - 250
9 DISTRIBUTION CENTERS	(Inside) Back Cover

DISCLAIMER

This catalog contains parts information only. Before installing any part listed, consult the appropriate vehicle manufacturer's instructional manual for detailed installation instructions. Although the information in this catalog has been gathered from the best available sources and every possible effort has been made to ensure accuracy, we cannot accept responsibility for any errors or omissions. We would very much appreciate being advised of any inaccuracies which might come to your attention. Dura-Bond reserves the right to update and change product specifications at any time without notice.

WARRANTY

Dura-Bond Bearing Company products are warranted to be free from defects of materials or workmanship for one year from the date of purchase. Dura-Bond Bearing Company's responsibility is limited to the replacement value of the product if Dura-Bond determines the product to be defective under normal use and service. Claims for labor or related component cost will not be considered. No other warranty, either expressed or implied, is made.

Copywriter, Editor, Design Layout - William E. Dolak

© 2013 DURA-BOND BEARING COMPANY ALL RIGHTS RESERVED.

NO PORTION OF THIS CATALOG MAY BE REPRODUCED WITHOUT OUR EXPRESS WRITTEN PERMISSION.

NEW PART LISTING

PART NUMBER	PRODUCT DESCRIPTION	MAKE
CAM BEARINGS		
CAT-8	Cam Bearing Set	Caterpillar
CH-10X10	Cam Bearing Set	GM
CH-10X20	Cam Bearing Set	GM
CH-25	Cam Bearing Set	GM
CHP-25	HP Cam Bearing Set	GM
CHP-25T	HP Cam Bearing Set	GM
DT-1	HP Cam Bearing Set	Dart
F-23BX10	Cam Bearing Set	Ford
F-57	Cam Bearing Set	Ford
FA-13L	OHC Cam Bearing Set	Ford
FA-13LX10	OHC Cam Bearing Set	Ford
FA-13LX20	OHC Cam Bearing Set	Ford
FA-13R	OHC Cam Bearing Set	Ford
FA-13RX10	OHC Cam Bearing Set	Ford
FA-13RX20	OHC Cam Bearing Set	Ford
FA-14L	OHC Cam Bearing Set	Ford
FA-14R	OHC Cam Bearing Set	Ford
FA-3X20	OHC Cam Bearing Set	Ford
FA-6X10	OHC Cam Bearing Set	Ford
FA-6X20	OHC Cam Bearing Set	Ford
FP-01	HP Cam Bearing Set	Ford -Specialty Aftermarket Blocks
FP-01R1	HP Cam Bearing Set	Ford -Specialty Aftermarket Blocks
FP-30AT	HP Cam Bearing Set	Ford
GM-12	Cam Bearing Set	GM
GM-25	Cam Bearing Set	GM
GMP-25	HP Cam Bearing Set	GM
GMP-25T	HP Cam Bearing Set	GM
LR-1	Cam Bearing Set	Rover
MA-11	Cam Bearing Set	Mack
MAG-11	Auxiliary Shaft Set	Mack
N-7BW	Cam Bearing Set	American Motors, Eagle, IHC, Jeep
NIG-1	Auxiliary/Balance Shaft Set	Nissan
PD-28X20	Cam Bearing Set	Chrysler, Eagle
PD-28X30	Cam Bearing Set	Chrysler, Eagle
PD-31BW	Cam Bearing Set	Chrysler
PDA-4X10	OHC Cam Bearing Set	Chrysler
VWA-2X30	OHC Cam Bearing Set	Volkswagen
VWA-2X40	OHC Cam Bearing Set	Volkswagen
WA-12	Cam Bearing Set	Waukesha
ENGINE HARDWARE		
AD-013	Head Dowel	GM
AD-018	Head Dowel	GM
AD-026	Seal Housing Dowel	GM
AD-027	Block Mating Dowel	Subaru
AD-046	Timing Cover Dowel	GM
AD-394	Cam Cap/Tower Dowel	Toyota
AD-397A	Bellhousing Dowel	Ford
AD-605	Crankshaft Insert	GM
AK-166-P	Woodruff Key	GM
AP-018	Head Plug	Nissan
AP-019	Head Plug	Nissan
AP-020	Head Plug	Ford
AV-001-P	Bypass Valve	GM
AV-280-P	Bypass Valve	GM
AV-580-PHD	Bypass Valve	GM
DP-22-P	Expansion Plug	Waukesha

NEW PART LISTING

PART NUMBER	PRODUCT DESCRIPTION	MAKE
ENGINE HARDWARE (Cont'd)		
PIN-1-P	Retaining Linkage Shaft Pin	GM
SPT-1	Spark Plug Tube	Chrysler
SPT-2	Spark Plug Tube	Toyota
SPT-3	Spark Plug Tube	Toyota
SPT-4	Spark Plug Tube	GM
SPT-5	Spark Plug Tube	Toyota
SR-183	Spring Retainer	Ford
SR-366	Spring Retainer	GM
SR-627	Spring Retainer	Chrysler
SR-779	Spring Retainer	Caterpillar
SR-809	Spring Retainer	GM
TC-1-00	Coolant Tube (O-Ring)	Ford
TC-5	Coolant Tube	Toyota
U140-190	Planetary Sleeve	Toyota
U140-250	Planetary Sleeve	Toyota
VALVE SEATS		
17563C	"Killer Bee" Copper-Infiltrated Seats	NA
17846C	"Killer Bee" Copper-Infiltrated Seats	NA
17904C	"Killer Bee" Copper-Infiltrated Seats	NA
20659C	"Killer Bee" Copper-Infiltrated Seats	NA
20907C	"Killer Bee" Copper-Infiltrated Seats	NA
22017C	"Killer Bee" Copper-Infiltrated Seats	NA
22018C	"Killer Bee" Copper-Infiltrated Seats	NA
22193C	"Killer Bee" Copper-Infiltrated Seats	NA
22194C	"Killer Bee" Copper-Infiltrated Seats	NA
22199C	"Killer Bee" Copper-Infiltrated Seats	NA
22228C	"Killer Bee" Copper-Infiltrated Seats	NA
22251C	"Killer Bee" Copper-Infiltrated Seats	NA
22252C	"Killer Bee" Copper-Infiltrated Seats	NA
22264C	"Killer Bee" Copper-Infiltrated Seats	NA
22365C	"Killer Bee" Copper-Infiltrated Seats	NA
30643C	"Killer Bee" Copper-Infiltrated Seats	NA
31091C	"Killer Bee" Copper-Infiltrated Seats	NA
31949C	"Killer Bee" Copper-Infiltrated Seats	NA
32130C	"Killer Bee" Copper-Infiltrated Seats	NA
32182C	"Killer Bee" Copper-Infiltrated Seats	NA
32210C	"Killer Bee" Copper-Infiltrated Seats	NA
32233C	"Killer Bee" Copper-Infiltrated Seats	NA
32366C	"Killer Bee" Copper-Infiltrated Seats	NA
72405C	"Killer Bee" Copper-Infiltrated Seats	NA
72419C	"Killer Bee" Copper-Infiltrated Seats	NA
72432C	"Killer Bee" Copper-Infiltrated Seats	NA
<p>Note: For the NEW standard valve seats (30000, 70000, 90000 Series). Please refer to the valve seat section for the complete listing.</p>		

NEW PART LISTING

PART NUMBER	PRODUCT DESCRIPTION	MAKE
VALVE SPRING BOOSTER SHIMS		
1011	(.015 Thickness) Shim	NA
1126	(.015 Thickness) Shim	NA
1175	(.015 Thickness) Shim	NA
1176	(.015 Thickness) Shim	NA
1177	(.015 Thickness) Shim	NA
1178	(.015 Thickness) Shim	NA
3011	(.030 Thickness) Shim	NA
3126	(.030 Thickness) Shim	NA
3175	(.030 Thickness) Shim	NA
3176	(.030 Thickness) Shim	NA
3177	(.030 Thickness) Shim	NA
3178	(.030 Thickness) Shim	NA
6011	(.060 Thickness) Shim	NA
6126	(.060 Thickness) Shim	NA
6175	(.060 Thickness) Shim	NA
6176	(.060 Thickness) Shim	NA
6177	(.060 Thickness) Shim	NA
6178	(.060 Thickness) Shim	NA



TIME TESTED

[*Quality Camshaft Bearings Since 1947*]

Dura-Bond bimetal bearings are constructed of seamless steel tube with a thin layer of lead based babbitt material. Seamless construction makes installation easy, eliminating breakage and bearing surface interruptions.

Lead based babbitt provides ideal properties for nearly all engine applications. Babbitt's superior embedability, conformability, and anti-seizure characteristics have proven to reduce engine failures that harder bearing materials can cause.

The seamless, 100% machined surface design provides the tightest tolerances in the industry. The centerless ground OD, centerless bore ID results in wall variations of .0006 in., giving the customer increased system design flexibility.

Dura-Bond®



A MELLING COMPANY

3200 Arrowhead Dr., Carson City, NV 89706 · TEL 800.227.8360 · FAX 775.883.9497 · www.dura-bondbearing.com

RACE PROVEN. TIME TESTED.

Performance Engines Deserve HIGH PERFORMANCE Cam Bearings.

If you want to match performance levels and get the most out of your engines, use Dura-Bond "Red Box" High Performance Cam Bearings!

HIGH PERFORMANCE CAM BEARINGS

- Precision Machined - Centerless Ground/Bored
- More Than Double the Fatigue Strength of Standard Bearings - Withstands Racing Spring Loads
- Micro-Babbitt/Grain-Controlled Babbitt/Roller Burnished

"COATED" HIGH PERFORMANCE CAM BEARINGS

- Retains Engine Oil On the Surface, Even Under Extreme Heat and Pressure
- Secondary Lubrication In the Event Momentary Oil Starvation Occurs



Dura-Bond®
A MELLING COMPANY

Quality Camshaft Bearings Since 1947

3200 Arrowhead Dr., Carson City, NV 89706 · TEL (800) 227-8360 · FAX (775) 883-9497 · www.dura-bondbearing.com

ENHANCED ENGINEERING SOLUTIONS



For the past 60 years our customers have come to expect our diverse, high level of service. They know that beyond the manufacture of component parts we are a valued partner in solving problems. From engineering design, to prototype development, sourcing and assembly work...they depend on us as their partner. Our team of Design, Materials, Application and Manufacturing Engineers are ready to be a part of your team in simultaneous engineering and integration.

Dura-Bond Provides the Rebuilder with Enhanced Engineering Solutions!

- Redesigned sets from O.E. to improve in the aftermarket (i.e. B-12B, CH-11B, CH-12B, CH-18A, F-47B and PD-28B)
- O.D. grooved to increase oil flow and optimize oil inlet locations
- Oversize O.D. Bearings for blue printing blocks
- Undersize I.D. sets for optimizing oil clearance
- Semi-Finished I.D. for line boring requirements



3200 Arrowhead Drive · Carson City, NV 89706 · 800.227.8360 TEL · 775.883.9497 FAX · www.dura-bondbearing.com

CAMSHAFT BEARINGS

DISPLACEMENT				YEAR	GENERAL APPLICATION DATA (ENGINE SERIES/MAKE/MODEL)	CAMSHAFT BEARING SET		
CYL.	CI./CC.	L	BORE			STD.	HI-PERF.	OHC
ACURA (Also see Honda)								
4 cyl	- 2156cc	2.2L	3.346" 85mm	1997	SOHC Honda (V-TEC) Eng. F22B1 Series			HA-3* (1/2 Shell)
5 cyl	- 2451cc	2.5L	3.346" 85mm	1992-98	SOHC Honda Eng. G25A1, G25A4 Series			HA-5* (1/2 Shell)
ALLIS CHALMERS								
4 cyl	116ci	1.9L	3.250" 82.6mm	1938-63	Allis Chalmers Eng. B,1B, B15 Tractor (Thru. Serial #64500), 60H, RC, TL6 Harvester, 66 Combine	A-1		
4 cyl	125ci	2.0L	3.375" 85.7mm	1957-63	Allis Chalmers Eng. B15 Tractor (From Serial #64501), B125, Roto Baler	A-1		
4 cyl	149ci	2.4L	3.500" 88.9mm	ALL	Allis Chalmers Eng. 60H, 148, BE, G149 Series; D Series: TRactor, H3 Crawler, I-40 Dozer, RT40 Forklift	A-6		
4 cyl	153ci	2.5L	3.438" 87.3mm	1956-69	Allis Chalmers Eng. 153 Series (Includes B153, BD153, D153, DA153, G153); AT40, F, FD, FL, FP, FT, T, TD, TG Series Forklift; HD Series Tractor	BU-2		
4 cyl	175ci	2.9L	3.563" 90.5mm	1960-70	Buda Diesel Eng. D175, DA175 Series; AT, F Series Forklift; I Series Tractor	BU-2		
4 cyl	182ci	3.0L	3.750" 95.3mm	1956-58	Buda Eng. 4B, 4BD, 4DA, 182, B182, BD182 Series; FT50, FT50-24 Series Forklift	BU-2		
4 cyl	200ci	3.3L	3.875" 98.4mm	ALL	Allis Chalmers Diesel/Turbo-Diesel Eng. 433, 433T, 2200, D2200, G2200 Series; 860 Harvester. 940, 7000, HD4 Series Tractor	A-3		
4 cyl	201ci	3.3L	4.000" 101.6mm	1958-70	Allis Chalmers Eng. 100, 100SP, G201, W, WC (After W136655), WD-F, W25, W201 Series Combine/Tractor	A-2		
4 cyl	226ci	3.7L	4.000" 101.6mm	1933-70	Allis Chalmers Eng. G, G226, W, WD45, W226 Series; 100SP, 170, D, M, TL, W Series Combine/Tractor	A-2		
6 cyl	230ci	3.8L	3.438" 87.3mm	1956-70	Buda Eng. 6B, 6DA, B230, BD230, D230, DA230, G230, W230, WD45D, WD45EX Series	BU-2		
6 cyl	262ci	4.3L	3.563" 90.5mm	1958-70	Buda Eng. B262, D262, D262T, DA262, G262, 6B262, 6D262, 6D262T, 6G262 Series	BU-2		
6 cyl	265ci	4.3L	3.750" 95.3mm	ALL	Allis Chalmers Eng. G2500 Series	A-4		
6 cyl	273ci	4.5L	3.750" 95.3mm	1956-60	Allis Chalmers Eng. 6D273, 6DA273, 6DAMR273, 6G273, D273, G273 Series; TL14DA Tractor	BU-2		
6 cyl	301ci	4.9L	3.875" 98.4mm	ALL	Allis Chalmers Eng. 649, 649T, 2800, 2900, D2800, D2900, G2800, G2900 Series; 180-200, 545, 860, 7000-8010, L3, M-MH3, TL Tractor, Combine, Grader	A-4		
6 cyl	426ci	7.0L	4.250" 108mm	ALL	Allis Chalmers Eng. 3400, 3400 MKII, 3500, 3500 MKII, 3700, 3750, D Series	A-5		
AMERICAN MOTORS								
4 cyl	150ci	2.5L	3.875" 98.5mm	1983-84	OHV AMC Eng. Vin U (Special Oil Control Set w/ OD Groove No. 2, 3 Position) (Special Oil Control Set w/ OD Groove No. 2, 3 Position), (.001 Under ID)	N-7 N-7B N-7BW		
4 cyl	151ci	2.5L	4.000" 101.6mm	1980-83	OHV GMC/Pontiac Eng. Vin B (.001 Under ID)	CH-16 CH-16W		
6 cyl	172ci	2.8L	3.125" 79.4mm	1949-52	AMC Eng.	N-6		
6 cyl	184ci	3.0L	3.125" 79.4mm	1950-54	Nash (L-Head) Eng.	N-6		
6 cyl	196ci	3.2L	3.125" 79.4mm	1953-65	OHV AMC (L-Head) Eng. Vin A, B, C	N-6		
6 cyl	199ci	3.3L	3.750" 95.3mm	1965-70	OHV AMC Eng. Vin A, B, E, J, P (Special Oil Control Set w/ OD Groove No. 2, 3 Position) (Special Oil Control Set w/ OD Groove No. 2, 3 Position), (.001 Under ID)	N-7 N-7B N-7BW		

* Denotes (OHC) Repair Bearing, Check "Aluminum Overhead Cam Accessories" Section For Tool Information

** Denotes Auxiliary / Balance Shaft Bearing.

"und" Denotes Undersized ID

CAMSHAFT BEARINGS

DISPLACEMENT				YEAR	GENERAL APPLICATION DATA (ENGINE SERIES/MAKE/MODEL)	CAMSHAFT BEARING SET		
CYL.	CI/CC.	L	BORE			STD.	HI-PERF.	OHC
AMERICAN MOTORS (Cont.)								
6 cyl	232ci	3.8L	3.750" 95.3mm	1964-79	OHV AMC (Hi-Torque) Eng. Vin B, C, E, F, G, L, M, P, Q, S, T, V, W (Special Oil Control Set w/ OD Groove No. 2, 3 Position) (Special Oil Control Set w/ OD Groove No. 2, 3 Position), (.001 Under ID)	N-7 N-7B N-7BW		
8 cyl	250ci	4.1L	3.500" 88.9mm	1956-62	OHV AMC Eng.	H-5		
6 cyl	258ci	4.2L	3.750" 95.3mm	1971-88	OHV AMC Eng. Vin A, B, C (Special Oil Control Set w/ OD Groove No. 2, 3 Position) (Special Oil Control Set w/ OD Groove No. 2, 3 Position), (.001 Under ID)	N-7 N-7B N-7BW		
8 cyl	287ci	4.7L	3.750" 95.3mm	1963-67	OHV AMC Eng. Vin H, N, T	H-5		
8 cyl	290ci	4.7L	3.750" 95.3mm	1966-69	OHV AMC Eng. Vin C, D, H, M, N, U (+.010 OD)	N-9 N-9R1		
8 cyl	304ci	5.0L	3.750" 95.3mm	1970-79	OHV AMC Eng. Vin H, I, M (+.010 OD)	N-9 N-9R1		
8 cyl	327ci	5.3L	4.000" 101.6mm	1956-66	OHV AMC (Vigilante) Eng. Vin J, K, P, Q, U, W	H-5		
8 cyl	343ci	5.6L	4.080" 103.6mm	1967-69	OHV AMC Eng. Vin J, K, Q, R, S, T, V, W, X, Z (+.010 OD)	N-9 N-9R1		
8 cyl	360ci	5.9L	4.080" 103.6mm	1970-78	OHV AMC Eng. Vin H, N, P (+.010 OD)	N-9 N-9R1		
8 cyl	390ci	6.4L	4.165" 105.9mm	1968-70	OHV AMC Eng. Vin W, X, Y (+.010 OD)	N-9 N-9R1		
8 cyl	401ci	6.6L	4.165" 105.9mm	1971-76	OHV AMC Eng. Vin Z (+.010 OD)	N-9 N-9R1		
AUDI								
4 cyl	- 1471cc	1.5L	3.012" 76.5mm	1973-74	SOHC VW Eng. XV, XW, XY, XZ, ZD, ZE Series (Balance Shaft Set)	VWG-1**		
4 cyl	97ci 1588cc	1.6L	3.012" 76.5mm	1982-83	SOHC VW Diesel/Turbo-Diesel Eng. CR, CY, JK Series, Vin G, H (Balance Shaft Set)	VWG-1**		
4 cyl	97ci 1588cc	1.6L	3.130" 79.5mm	1975-80	SOHC VW Eng. YG, YH, YK, Series (Balance Shaft Set)	VWG-1**		
4 cyl	104.7ci 1715cc	1.7L	3.130" 79.5mm	1981-83	SOHC VW Eng. WT Series, Vin A (Balance Shaft Set)	VWG-1**		
5 cyl	- 1986cc	2.0L	3.012" 76.5mm	1979-85	SOHC VW Diesel/Turbo-Diesel Eng. CN, DE Series, Vin G, H			VWA-1* (1/2 Shell)
5 cyl	- 2144cc	2.2L	3.130" 79.5mm	1978-85	SOHC VW Eng. KH, WD, WE, WK, WU Series (Includes Turbo), Vin A, B, C			VWA-1* (1/2 Shell)
5 cyl	- 2226cc	2.2L	3.189" 81mm	1983-97	SOHC & DOHC VW Eng. 3B, AAN, JT, KX, KZ, MC, WX Series, Vin A, B, C, D, E, P, R			VWA-1* (1/2 Shell)
5 cyl	- 2309cc	2.3L	3.248" 82.5mm	1987-92	SOHC & DOHC VW Eng. 7A, NF, NG Series, Vin B, C, D, E			VWA-1* (1/2 Shell)
AUSTIN (AUSTIN HEALEY)								
4 cyl	52ci 848cc	0.8L	2.480" 63mm	1959-78	OHV British Leyland Eng. 85H, 8AM, 8MB Series	BL-1		
4 cyl	58ci 948cc	0.9L	2.478" 62.9mm	1956-62	OHV British Leyland Eng. 9C, 9CG Series	BL-1		

* Denotes (OHC) Repair Bearing, Check "Aluminum Overhead Cam Accessories" Section For Tool Information

** Denotes Auxiliary / Balance Shaft Bearing.

"und" Denotes Undersized ID

CAMSHAFT BEARINGS

DISPLACEMENT				YEAR	GENERAL APPLICATION DATA (ENGINE SERIES/MAKE/MODEL)	CAMSHAFT BEARING SET		
CYL.	CI./CC.	L	BORE			STD.	HI-PERF.	OHC
AUSTIN (AUSTIN HEALEY) (Cont.)								
4 cyl	59ci 970cc	1.0L	2.780" 70.6mm	1964-69	OHV British Leyland Eng.	BL-1		
4 cyl	61ci 997cc	1.0L	2.457" 62.4mm	1961-69	OHV British Leyland Eng.	BL-1		
4 cyl	61ci 998cc	1.0L	2.542" 64.6mm	1961-78	OHV British Leyland Eng. 99H, 9AG Series	BL-1		
4 cyl	65ci 1071cc	1.1L	2.780" 70.6mm	1963-65	OHV British Leyland Eng.	BL-1		
4 cyl	- 1098cc	1.1L	2.542" 64.6mm	1962-78	OHV British Leyland Eng. 10CC, 10CG Series	BL-1		
4 cyl	91ci 1489cc	1.5L	2.874" 73mm	1955-61	OHV British Leyland Eng. 14H Series	DA-2		
4 cyl	99ci 1622cc	1.6L	3.000" 76.2mm	1962-64	OHV British Leyland Eng.	DA-2		
4 cyl	- 1798cc	1.8L	3.160" 80.3mm	1973-75	OHV MG Eng. 18V Series	DA-2		
BMW								
4 cyl	107ci 1766cc	1.8L	3.504" 89mm	1980-85	SOHC BMW Eng. M10 Series			BMA-4* (Full Round)
4 cyl	121ci 1990cc	2.0L	3.504" 89mm	1965-79	SOHC BMW Eng. 121, M10, M10B20, M15 Series			BMA-4* (Full Round)
6 cyl	152ci 2494cc	2.5L	3.307" 84mm	1987-93	SOHC BMW Eng. M20 Series			BMA-3* (Full Round)
6 cyl	- 2693cc	2.7L	3.307" 84mm	1982-88	SOHC BMW Eng. M20 Series			BMA-2* (Full Round)
6 cyl	- 2788cc	2.8L	3.386" 86mm	1968-81	SOHC BMW Eng. M30, M30B28 Series			BMA-1* (Full Round)
6 cyl	- 2985cc	3.0L	3.504" 89mm	1971-78	SOHC BMW Eng. M30, M30B30 Series			BMA-1* (Full Round)
6 cyl	- 3210cc	3.2L	3.500" 88.9mm	1978-84	SOHC BMW Eng. M30 Series			BMA-1* (Full Round)
6 cyl	- 3430cc	3.5L	3.622" 92mm	1985-93	SOHC BMW Eng. M30 Series			BMA-1* (Full Round)
6 cyl	- 3453cc	3.5L	3.661" 93mm	1987-88	DOHC BMW Eng. S38 Series			BMA-1* (Full Round)
BUDA								
4 cyl	153ci	2.5L	3.438" 87.3mm	ALL	Diesel Eng. 4B127, 4B153, 4BD153, 4D153, 4DA153, 4B157, 4B158, 4G153 Series	BU-2		
4 cyl	175ci	2.9L	3.563" 90.5mm	ALL	Diesel Eng. 4BD175, 4D175, 4DA175 Series	BU-2		
4 cyl	182ci	3.0L	3.750" 95.3mm	ALL	4B182, 4BD182, 4DA182 Series	BU-2		
6 cyl	230ci	3.8L	3.438" 87.33mm	ALL	6B230, 6BD230, 6D230, 6DA230, 6G230 Series	BU-2		
6 cyl	262ci	4.3L	3.563" 90.5mm	ALL	Diesel Eng. 6B262, 6D262, 6D262T, 6DA262, 6DD262, 6G262 Series	BU-2		
6 cyl	273ci	4.5L	3.750" 95.3mm	ALL	Diesel Eng. 6B273, 6BD273, 6D273, 6DA273 Series	BU-2		
CASE TRACTOR								
4 cyl	95ci	1.6L	2.750" 69.9mm	1936-40	FC Series	WA-3		

* Denotes (OHC) Repair Bearing, Check "Aluminum Overhead Cam Accessories" Section For Tool Information

** Denotes Auxiliary / Balance Shaft Bearing.

"und" Denotes Undersized ID

CAMSHAFT BEARINGS

DISPLACEMENT				YEAR	GENERAL APPLICATION DATA (ENGINE SERIES/MAKE/MODEL)	CAMSHAFT BEARING SET		
CYL.	CI/CC.	L	BORE			STD.	HI-PERF.	OHC
CASE TRACTOR (Cont.)								
4 cyl	106ci	1.7L	3.000" 76.2mm	ALL	W106 Series	CA-3		
4 cyl	123ci	2.0L	3.125" 79.4mm	1936-40	FK Series	WA-3		
4 cyl	124ci	2.0L	3.250" 82.6mm	1942-58	124, F124, VA124, VA, VAE Series	CA-3		
4 cyl	126ci	2.1L	3.125" 79.4mm	1955-61	126, G126 Series	CA-3		
4 cyl	148ci	2.4L	3.375" 85.7mm	1955-70	148, 148B, 148G, G148, G148B, G149 Series	CA-3		
4 cyl	159ci	2.6L	3.500" 88.9mm	1961-70	159, 159B, 159G, G159, G159B Series	CA-3		
4 cyl	164ci	2.7L	3.563" 90.5mm	1957-64	164, G164 Series	CA-3		
3 cyl	180ci	2.9L	4.016" 102mm	ALL	Cummins Diesel/Turbo-Diesel Eng. 3B, 3BT B Series (Used In No. 1 Position)	CU-12		
4 cyl	188ci	3.1L	3.813" 96.9mm	1977-On	188D, G188D Series (w/ Tach Drive)	CA-9		
4 cyl	188ci	3.1L	3.813" 96.9mm	1977-On	188D, G188D Series (Engines w/ 1.218" Length On No. 5 Positon, Without Tach Drive)	CA-5		
4 cyl	188ci	3.1L	3.813" 96.9mm	1963-70	188, 188B, 188S, G188 Series	CA-8		
4 cyl	188ci	3.1L	3.813" 96.9mm	1963-70	G188B Series	CA-4		
4 cyl	201ci	3.3L	3.938" 100mm	ALL	201 Series, 660 Combine	CA-8		
4 cyl	207ci	3.4L	4.000" 101.6mm	1977-On	Diesel Eng. 207, 207D, G-207D Series (w/ Tach Drive)	CA-9		
4 cyl	238ci	3.9L	4.016" 102mm	ALL	Cummins Diesel/Turbo-Diesel Eng. 4-390, 4T-390 B Series (Used In No. 1 Position)	CU-12		
4 cyl	251ci	4.1L	4.000" 101.6mm	1957-69	251, 251B, 251BG, 251D, A251, A251G, A251LP, A251S Series (Late Eng. w/ 2.250" Dia Journals)	CA-6		
4 cyl	267ci	4.4L	4.125" 104.8mm	1955-70	Diesel Eng. 267, 267B, 267BD, A267, A267D Series (Late Eng. w/ 2.250" Dia Journals)	CA-6		
4 cyl	284ci	4.7L	4.250" 108mm	1961-69	284, 284B, A284G, A284LP, A284S Series (Late Eng. w/ 2.250" Dia Journals)	CA-6		
4 cyl	301ci	5.0L	4.375" 111.1mm	1961-69	Diesel Eng. 301, 301B, 301BD, 301BG, A301, A301BD, A301D, A301DF Series (Late Eng. w/ 2.250" Dia Journals)	CA-6		
4 cyl	336ci	5.5L	4.625" 117.5mm	ALL	Diesel Eng. 336, 336B, 336BD, 336BDT Series (Late Eng. w/ 2.250" Dia Journals)	CA-6		
6 cyl	360ci	5.9L	4.016" 102mm	ALL	Cummins Diesel/Turbo-Diesel Eng. 6-590B, 6T-590 B Series (Used in No. 1 Position)	CU-12		
6 cyl	377ci	6.2L	4.000" 101.6mm	1953-66	377, 377A, 377BG, A377, A377D, A377G, A377LP, A377S Series (After Serial #2323001) (Late Eng. w/ 2.250" Dia Journals)	CA-7		
6 cyl	401ci	6.6L	4.125" 104.8mm	1961-69	Diesel/Turbo-Diesel Eng. 401, 401B, 401BD, 401BDT, 401D, A401, A401B, A401BD, A401D Series (Late Eng. w/ 2.250" Dia Journals)	CA-7		
6 cyl	451ci	7.4L	4.375" 111.1mm	1965-69	Diesel/Turbo-Diesel Eng. 451, 451B, 451BD, 451BDT, 451D, 451DT, A451BD, A451D Series (Late Eng. w/ 2.250" Dia Journals)	CA-7		
6 cyl	504ci	8.3L	4.625" 117.5mm	ALL	Diesel/Turbo-Diesel Eng. 504, 504B, 504BD, 504BDT, 504BDTI, 504D, 504DT, 504DTI, 504TC, A504BD, A504BDT Series	CA-7		

* Denotes (OHC) Repair Bearing, Check "Aluminum Overhead Cam Accessories" Section For Tool Information

** Denotes Auxiliary / Balance Shaft Bearing.

"und" Denotes Undersized ID

CAMSHAFT BEARINGS

DISPLACEMENT				YEAR	GENERAL APPLICATION DATA (ENGINE SERIES/MAKE/MODEL)	CAMSHAFT BEARING SET		
CYL.	CI./CC.	L	BORE			STD.	HI-PERF.	OHC
CATERPILLAR								
4 cyl	269ci	4.4L	4.135" 105mm	ALL	Diesel Eng. 3114 Series	CAT-8		
4 cyl	350ci	5.7L	4.500" 114.3mm	ALL	Diesel Eng. 1670, D330 Series (No. 1 Position, OE#9M5477) (No. 2, 3 Position, OE#7M4046) (Balance Shaft Bearings: No. 1, 2, 5, 6 Position, OE#9M5239) (Balance Shaft Bearings: No. 3, 4 Position, OE#9M5238)	CAT-2-1 CAT-2-2 CAT-2-5 CAT-2-6		
6 cyl	403ci	6.6L	4.134" 105mm	ALL	Diesel Eng. 3116 Series	CAT-5		
4 cyl	425ci	7.0L	4.750" 120.7mm	ALL	Diesel Eng. 3304, D330 Series (No. 1 Position, OE#9M5477) (No. 2, 3 Position, OE#7M4046) (Balance Shaft Bearings: No. 1, 2, 5, 6 Position, OE#5S6419) (Balance Shaft Bearings: No. 3, 4 Position, OE#5S6420)	CAT-2-1 CAT-2-2 CAT-2-3 CAT-2-4		
8 cyl	522ci	8.5L	4.500" 114.3mm	ALL	Diesel Eng. 1140, 1145, 3145 Series	CAT-2		
6 cyl	525ci	8.6L	4.500" 114.3mm	ALL	Diesel Eng. D333, D333A, G333, 1673 Series (No. 1 Position, OE#9M5477) (No. 2, 3, 4, 5 Position, OE#7M4046) (Balance Shaft Bearings: No. 1, 2, 5, 6 Position, OE#9M5239) (Balance Shaft Bearings: No. 3, 4 Position, OE#9M5238)	CAT-2-1 CAT-2-2 CAT-2-5 CAT-2-6		
6 cyl	573ci	9.4L	4.500" 114.3mm	ALL	Diesel Eng. 1150, 3150 Series	CAT-2		
8 cyl	636ci	10.4L	4.500" 114.3mm	ALL	Diesel Eng. 1160, 3160, 3208, V150, V175, V200, V225 Series	CAT-2		
6 cyl	638ci	10.5L	4.750" 120.7mm	ALL	Diesel Eng. D333, D334, 1673, 1674, 3306 Series (Balance Shaft Set)	CAT-6 CAT-7**		
4 cyl	831ci	13.6L	5.750" 146.1mm	ALL	Diesel Eng. D339, D7700, D8800 Series (No. 1 Position, OE#4H9640, 8F8521) (No. 2 Position, OE#8F8523)	CAT-3-1 CAT-3-2		
6 cyl	1246ci	20.4L	5.750" 146.1mm	ALL	Diesel Eng. D342, D13000, G342 Series (No. 1 Position, OE#4H9640, 8F8521) (No. 2 Position, OE#8F8523)	CAT-3-1 CAT-3-2		
CHECKER MOTORS CORP.								
6 cyl	226ci	3.7L	3.312" 84.1mm	1947-64	OHV Continental (L-Head) Eng. F226 Series	K-1		
6 cyl	229ci	3.8L	3.736" 94.9mm	1980-82	OHV Chevrolet Eng. (.001 Under ID)	CH-17 CH-17X	CHP-17 or CHP-17T (Coated)	
6 cyl	230ci	3.8L	3.875" 98.4mm	1964-68	OHV Chevrolet Eng. HF, OK Series	CH-7		
6 cyl	250ci	4.1L	3.875" 98.4mm	1969-70	OHV Chevrolet Eng. (Early Models)	CH-7		
6 cyl	250ci	4.1L	3.875" 98.4mm	1971-79	OHV Chevrolet Eng. (Late Models), Vin D (Special Oil Control Set w/ OD Groove)	CH-11 CH-11B		
8 cyl	267ci	4.4L	3.500" 88.9mm	1980-82	OHV Chevrolet Eng.	CH-8	CHP-8 or CHP-8T (Coated)	
8 cyl	283ci	4.6L	3.875" 98.4mm	1964-67	OHV Chevrolet Eng. C, GA Series	CH-8	CHP-8 or CHP-8T (Coated)	

* Denotes (OHC) Repair Bearing, Check "Aluminum Overhead Cam Accessories" Section For Tool Information

** Denotes Auxiliary / Balance Shaft Bearing.

"und" Denotes Undersized ID

CAMSHAFT BEARINGS

DISPLACEMENT				YEAR	GENERAL APPLICATION DATA (ENGINE SERIES/MAKE/MODEL)	CAMSHAFT BEARING SET		
CYL.	CI/CC.	L	BORE			STD.	HI-PERF.	OHC
CHECKER MOTORS CORP. (Cont.)								
8 cyl	305ci	5.0L	3.736" 94.9mm	1977-82	OHV Chevrolet Eng.	CH-8	CHP-8 or CHP-8T (Coated)	
8 cyl	307ci	5.0L	3.875" 98.4mm	1968-70	OHV Chevrolet Eng. CNC, CND, CNE, CNF, DA, DB, DC, DD, DE, DN Series	CH-8	CHP-8 or CHP-8T (Coated)	
8 cyl	318ci 5212cc	5.2L	3.906" 99.2mm	1959-66	OHV Chrysler Eng. A318, MD2, P31, R31, S31, T31, V31 Series	PD-16	PDP-16 or PDP-16T (Coated)	
8 cyl	327ci	5.3L	4.000" 101.6mm	1964-69	OHV Chevrolet Eng. EA, FJ, JQ, MA Series	CH-8	CHP-8 or CHP-8T (Coated)	
8 cyl	350ci	5.7L	4.000" 101.6mm	1969-79	OHV Chevrolet Eng. Vin L	CH-8	CHP-8 or CHP-8T (Coated)	
CHEVROLET (MARINE)								
4 cyl	181ci	3.0L	4.000" 101.6mm	1982	Marine/Industrial Eng.	CH-6		
CHRYSLER CORP. (DODGE, PLYMOUTH)								
4 cyl	- 1410cc	1.4L	2.913" 74mm	1979-84	SOHC Mitsubishi Eng. G12B Series, Vin 2, A, J			MIA-3* (Full Round)
4 cyl	90ci 1468cc	1.5L	2.972" 75.5mm	1985-95	SOHC Mitsubishi Eng. 4G15, G15B Series, Vin A, K, P, Q, X			MIA-3* (Full Round)
4 cyl	98ci 1597cc	1.6L	3.028" 76.9mm	1971-88	SOHC Mitsubishi Eng. G32B, G32B-T, 4G32 Series (Includes Turbo), Vin 3, B, F, K, Z (Cam Bearing Set w/ Heavy Wall, +.020 OD)			MIA-1* (1/2 Shell) MIA-2* (1/2 Shell)
4 cyl	105ci	1.7L	3.130" 79.5mm	1978-83	SOHC VW Eng. Vin A, B (Balance Shaft Set)	VWG-1**		
4 cyl	122ci 1995cc	2.0L	3.307" 84mm	1974-89	SOHC (8 Valve) Mitsubishi Eng. 4G52, G52B Series, Vin 5, D, U (Balance Shaft Set) (Balance Shaft Bearing w/ .173 Oversize OD) (Balance Shaft Elim)	MIG-2** MIG-2-1R MIG-2E**		
4 cyl	122ci 1997cc	2.0L	3.346" 85mm	1984-94	SOHC & DOHC Mitsubishi Eng. G63B, 4G63, 4G63-T Series (Includes Turbo), Vin D, E, F, R, U, V (Balance Shaft Set)	MIG-3**		
4 cyl	122ci 1996cc	2.0L	3.445" 87.5mm	1995-05	SOHC (16 Valve) Chrysler Eng. ECB Series, Vin C, F			PDA-3* (Full Round)
4 cyl	135ci 2212cc	2.2L	3.445" 87.5mm	1981-94	SOHC Chrysler Eng. (Includes Turbo), Vin 8, A, B, C, D, E, F, P (.020 Oversize Bearing Set) (Balance Shaft Set)	PDG-26**		PDA-1* (1/2 Shell) PDA-2* (1/2 Shell)
4 cyl	143ci 2346cc	2.3L	3.587" 91.1mm	1983-85	SOHC Mitsubishi Turbo-Diesel Eng. 4D55-T Series, Vin 9, J (Balance Shaft Set) (Balance Shaft Bearing w/ .173 Oversize OD) (Balance Shaft Elim)	MIG-2** MIG-2-1R MIG-2E**		
4 cyl	143.4ci 2351cc	2.4L	3.405" 86.5mm	1990-94	SOHC (8 Valve) Mitsubishi Eng. 4G64 Series, Vin G, W (Cam Bearing Set w/ Heavy Wall, +.020 OD) (Balance Shaft Set)	MIG-3**		MIA-1* (1/2 Shell) MIA-2* (1/2 Shell)
4 cyl	153ci 2507cc	2.5L	3.445" 87.4mm	1986-95	SOHC Chrysler Eng. (Includes Turbo), Vin G, J, K, V (.020 Oversize Bearing Set) (Balance Shaft Set - Semi-Finished)	PDG-29S**		PDA-1* (1/2 Shell) PDA-2* (1/2 Shell)

* Denotes (OHC) Repair Bearing, Check "Aluminum Overhead Cam Accessories" Section For Tool Information

** Denotes Auxiliary / Balance Shaft Bearing.

"und" Denotes Undersized ID

CAMSHAFT BEARINGS

DISPLACEMENT				YEAR	GENERAL APPLICATION DATA (ENGINE SERIES/MAKE/MODEL)	CAMSHAFT BEARING SET		
CYL.	CI./CC.	L	BORE			STD.	HI-PERF.	OHC
CHRYSLER CORP. (DODGE, PLYMOUTH) (Cont.)								
4 cyl	156ci 2555cc	2.6L	3.587" 91.1mm	1978-89	SOHC Mitsubishi Eng. G54B, G54B-T Series (Includes Turbo), Vin 7, D, E, F, G, H, N, W (Cam Bearing Set w/ Heavy Wall, +.020 OD) (Balance Shaft Set) (Balance Shaft Bearing w/ .173 Oversize OD) (Balance Shaft Elim)	MIG-2** MIG-2-1R MIG-2E**		MIA-1* (1/2 Shell) MIA-2* (1/2 Shell)
6 cyl	165.5ci	2.7L	-	1937-89	Chrysler Eng.	PD-3		
6 cyl	170ci 2786cc	2.8L	3.406" 86.5mm	1960-71	OHV Chrysler Eng. A170, P17, R17, S17, T17, V17 Series. Vin 6, A	PD-18		
6 cyl	181ci 2972cc	3.0L	3.587" 91.1mm	1987-05	SOHC & DOHC Mitsubishi Eng. 6G72, 6G72-T Series (Includes Turbo), Vin 3, B, C, H, J, K, S			MIA-5* (1/2 Shell)
6 cyl	198ci 3254cc	3.2L	3.406" 86.5mm	1970-74	OHV Chrysler Eng. Vin A, B	PD-18		
6 cyl	201ci 3301cc	3.3L	3.661" 93mm	1990-10	OHV Chrysler Eng. EGA, EGM, EGV Series. Vin 3, E, G, H, J, R, T, U (Special Oil Control Set w/ OD Groove No. 2, 3 Position)	PD-28 PD-28B		
6 cyl	218ci 3570cc	3.6L	3.250" 82.6mm	1933-56	Chrysler (L-Head) Eng.	PD-1		
6 cyl	218ci	3.6L	3.375" 85.7mm	1938-54	Chrysler (L-Head) Eng.	PD-3		
6 cyl	225ci 3687cc	3.7L	3.400" 86.4mm	1960-78	OHV Chrysler Eng. A225, P22, R22, S22, T22, V22 Series. Vin 6, B, C, D, E, X (Early Series w/ Forged Crankshaft)	PD-18		
6 cyl	225ci 3687cc	3.7L	3.400" 86.4mm	1979-87	OHV Chrysler Eng. Vin B, C, D, E, F, G, H, J, K, L, M, N, W (Late Series w/ Cast Crankshaft)	PD-21		
6 cyl	226ci 3704cc	3.7L	3.661" 93mm	2002-11	SOHC Chrysler Eng. Vin K (Balance Shaft Set)	PDG-30**		
6 cyl	228ci 3739cc	3.7L	3.374" 85.7mm	1936-56	Chrysler (L-Head) Eng.	PD-3		
6 cyl	230ci 3770cc	3.8L	3.248" 82.5mm	1934-60	Chrysler (L-Head) Eng. P23 Series	PD-1		
6 cyl	230ci	3.8L	3.780" 96mm	1991-08	OHV Chrysler Eng. EGH Series, Vin L, P (Special Oil Control Set w/ OD Groove No. 2, 3 Position)	PD-28 PD-28B		
6 cyl	231ci 3778cc	3.8L	3.780" 96mm	2009-10	OHV Chrysler Eng. Vin 1 (Special Oil Control Set w/ OD Groove No. 2, 3 Position)	PD-28 PD-28B		
6 cyl	237ci 3878cc	3.9L	3.438" 87.3mm	1937-53	Chrysler (L-Head) Eng.	PD-3		
6 cyl	239ci 3906cc	3.9L	3.910" 99.3mm	1987-03	OHV Chrysler Eng. Vin M, X	PD-27		
6 cyl	241.5ci	4.0L	3.375" 85.7mm	1937-41	Dodge (L-Head) Eng.	PD-3		
6 cyl	251ci 4114cc	4.1L	3.438" 87.3mm	1942-68	Chrysler (L-Head) Eng. A251, P25, R25, S25, T25, V25 Series, Vin 6	PD-3		
6 cyl	265ci 4343cc	4.3L	3.438" 87.3mm	1952-68	Chrysler (L-Head) Eng.	PD-3		
8 cyl	273ci 4473cc	4.5L	3.625" 92.1mm	1964-69	OHV Chrysler Eng. A273, V27 Series, Vin D	PD-16	PDP-16 or PDP-16T (Coated)	
8 cyl	277ci 4540cc	4.5L	3.750" 95.3mm	1956-57	OHV Chrysler Eng.	PD-16	PDP-16 or PDP-16T (Coated)	

* Denotes (OHC) Repair Bearing, Check "Aluminum Overhead Cam Accessories" Section For Tool Information

** Denotes Auxiliary / Balance Shaft Bearing.

"und" Denotes Undersized ID

CAMSHAFT BEARINGS

DISPLACEMENT				YEAR	GENERAL APPLICATION DATA (ENGINE SERIES/MAKE/MODEL)	CAMSHAFT BEARING SET		
CYL.	CI/CC.	L	BORE			STD.	HI-PERF.	OHC
CHRYSLER CORP. (DODGE, PLYMOUTH) (Cont.)								
8 cyl	285ci -	4.7L	3.661" 93mm	2002-10	SOHC Chrysler Eng. Vin J, N, P (Auxiliary Shaft Set)	PDG-1		PDA-4* (1/2 Shell)
8 cyl	287ci	4.7L	3.661" 93mm	2000-04	SOHC Chrysler Eng. Vin N, P (Auxiliary Shaft Set)	PDG-1		PDA-4* (1/2 Shell)
8 cyl	301ci 4933cc	4.9L	3.625" 92.1mm	1955	OHV Chrysler Eng.	PD-8		
8 cyl	303ci 4966cc	5.0L	3.811" 96.8mm	1956	OHV Chrysler Eng.	PD-16	PDP-16 or PDP-16T (Coated)	
8 cyl	313ci 5130cc	5.1L	3.875" 98.4mm	1957-64	OHV Chrysler Eng.	PD-16	PDP-16 or PDP-16T (Coated)	
8 cyl	318ci 5211cc	5.2L	3.910" 99.3mm	1957-79	OHV Chrysler Eng. A318, LD2, MD2, P31, R31, S31, T31, V31 Series, Vin 4, 8, E, F, G, H, P (.760" Length Center Bearing)	PD-16	PDP-16 or PDP-16T (Coated)	
8 cyl	318ci 5211cc	5.2L	3.910" 99.3mm	1980-03	OHV Chrysler Eng. Vin 2, 4, E, G, H, J, K, L, M, N, P, R, S, T, U, Y, Z	PD-25	PDP-25 or PDP-25T (Coated)	
8 cyl	326ci 5343cc	5.3L	3.953" 100.4mm	1959	OHV Chrysler Eng.	PD-16	PDP-16 or PDP-16T (Coated)	
8 cyl	331ci 5425cc	5.4L	3.813" 96.9mm	1951-56	OHV Chrysler Eng.	PD-8		
8 cyl	340ci 5572cc	5.6L	4.040" 102.6mm	1968-73	OHV Chrysler Eng. Vin H, J, P	PD-16	PDP-16 or PDP-16T (Coated)	
8 cyl	345ci 5654cc	5.7L	3.917" 99.6mm	2003-08	OHV Chrysler (Hemi) Eng. EZA, EZB Series. Vin 2, D, H (.001 Under ID)	PD-31B PD-31BW		
8 cyl	350ci 5737cc	5.7L	4.063" 103.2mm	1958	OHV Chrysler Eng. (+.010 OD)	PD-17	PDP-17 or PDP-17T (Coated) PDP-17R1	
8 cyl	354ci 5802cc	5.8L	3.938" 100mm	1955-59	OHV Chrysler Eng.	PD-8		
6 cyl	359ci	5.9L	4.016" 102mm	1989-98	OHV Cummins Turbo-Diesel Eng. ETA, ETB Series, Vin 8, C, D	CU-12		
6 cyl	359ci	5.9L	4.016" 102mm	1998-09	OHV Cummins (HO) Turbo-Diesel Eng. ETC, ETH Series, Vin 6, 7, C	CU-14		
8 cyl	360ci 5899cc	5.9L	4.000" 101.6mm	1970-78	OHV Chrysler Eng. Vin 8, F, J, K, L, T, Y (.760" Length Center Bearing)	PD-16	PDP-16 or PDP-16T (Coated)	
8 cyl	360ci	5.9L	4.000" 101.6mm	1979-03	OHV Chrysler Eng. Vin 1, 5, F, J, K, L, S, T, U, W, Z	PD-25	PDP-25 or PDP-25T (Coated)	
8 cyl	361ci 5917cc	5.9L	4.125" 104.8mm	1958-77	OHV Chrysler Eng. A361, D500, LD2S, LD3S, LS3S, MD3H, MD3L, MD3M, P36, R36, S36, T36, V36 Series, Vin F (+.010 OD)	PD-17	PDP-17 or PDP-17T (Coated) PDP-17R1	
8 cyl	370ci 6059cc	6.1L	4.055" 103mm	2005-10	OHV Chrysler (Hemi) Eng. ESF Series. Vin 3, W (.001 Under ID)	PD-31B PD-31BW		

* Denotes (OHC) Repair Bearing, Check "Aluminum Overhead Cam Accessories" Section For Tool Information

** Denotes Auxiliary / Balance Shaft Bearing.

"und" Denotes Undersized ID

CAMSHAFT BEARINGS

DISPLACEMENT				YEAR	GENERAL APPLICATION DATA (ENGINE SERIES/MAKE/MODEL)	CAMSHAFT BEARING SET		
CYL.	CI./CC.	L	BORE			STD.	HI-PERF.	OHC
CHRYSLER CORP. (DODGE, PLYMOUTH) (Cont.)								
8 cyl	383ci 6286cc	6.3L	4.250" 108mm	1959-71	OHV Chrysler Eng. A383, D500, MC1L, MC2M, P38, PR38, R38, S38, T38, V38 Series, Vin 8, G, H, J, L, N (+.010 OD)	PD-17	PDP-17 or PDP-17T (Coated) PDP-17R1	
8 cyl	392ci 6425cc	6.4L	4.000" 101.6mm	1957-58	OHV Chrysler Eng.	PD-8		
8 cyl	400ci 6556cc	6.6L	4.342" 110.2mm	1971-78	OHV Chrysler Eng. Vin J, M, N, P (+.010 OD)	PD-17	PDP-17 or PDP-17T (Coated) PDP-17R1	
8 cyl	413ci 6769cc	6.8L	4.188" 106.4mm	1959-77	OHV Chrysler Eng. A413, MC3H, MC3S, MY1H, MY1L, MY1M, P41, R41, S41, T41, V41 Series (+.010 OD)	PD-17	PDP-17 or PDP-17T (Coated) PDP-17R1	
8 cyl	426ci 6981cc	7.0L	4.250" 108mm	1963-71	OHV Chrysler Eng. A426, T42, V42, V426 Series, Vin H, J, R (+.010 OD)	PD-17	PDP-17 or PDP-17T (Coated) PDP-17R1	
8 cyl	440ci 7211cc	7.2L	4.320" 109.7mm	1966-79	OHV Chrysler Eng. B440, C440, PT440 Series, Vin A, D, K, L, M, T, U, V (+.010 OD)	PD-17	PDP-17 or PDP-17T (Coated) PDP-17R1	
10 cyl	488ci 7990cc	8.0L	4.000" 101.6mm	1992-03	OHV Chrysler (Magnum) Iron Block Eng. EWB Series, Vin E, W	PD-30		
CHRYSLER (MARINE)								
4 cyl	121.2ci 1986cc	2.0L	3.500" 88.9mm	ALL	Volvo Eng. 115, 130 Series (Auxiliary / Balance Shaft Set)	VO-2**		
6 cyl	182ci 2980cc	3.0L	3.500" 88.9mm	ALL	Volvo Eng. 165, 170 Series	VO-3		
CONTINENTAL								
4 cyl	69ci	1.1L	2.500" 63.5mm	ALL	LY69, PY69, Y4069, Y69 Series	CO-3		
4 cyl	91ci	1.5L	2.875" 73mm	ALL	LY91, P410, PY91, Y4091, Y91 Series	CO-3		
4 cyl	112ci	1.8L	3.188" 80.98mm	ALL	BY112, BY4112, PY112, PY4112, Y112, Y4112 Series	CO-3		
4 cyl	124ci	2.0L	3.000" 76.2mm	ALL	VAB124 Series	CA-3		
4 cyl	124ci	2.0L	3.000" 76.2mm	ALL	A4124, F124, F4124, LF124, PF124 Series	CO-8		
4 cyl	129ci	2.1L	3.250" 82.6mm	ALL	Z129 Series	CA-3		
4 cyl	134ci	2.2L	3.313" 84.1mm	ALL	Z134 Series	CA-3		
4 cyl	135ci	2.2L	3.125" 79.4mm	ALL	F135 Series	CO-8		
4 cyl	140ci	2.3L	3.188" 80.98mm	ALL	F140, F4140, LF140, PF140 Series	CO-8		
4 cyl	142ci	2.3L	3.000" 76.2mm	ALL	A4142, F4142 Series	CO-8		
4 cyl	145ci	2.4L	3.250" 82.6mm	ALL	FS145 Series	CO-8		
4 cyl	145ci	2.4L	3.375" 85.7mm	ALL	Z145 Series	CA-3		

* Denotes (OHC) Repair Bearing, Check "Aluminum Overhead Cam Accessories" Section For Tool Information

** Denotes Auxiliary / Balance Shaft Bearing.

"und" Denotes Undersized ID

CAMSHAFT BEARINGS

DISPLACEMENT				YEAR	GENERAL APPLICATION DATA (ENGINE SERIES/MAKE/MODEL)	CAMSHAFT BEARING SET		
CYL.	CI/CC.	L	BORE			STD.	HI-PERF.	OHC
CONTINENTAL (Cont.)								
4 cyl	162ci	2.6L	3.438" 87.3mm	ALL	F162, F4162, F4162 Super, LF162, PF162 Series	CO-8		
4 cyl	163ci	2.7L	3.438" 87.3mm	ALL	F163, F4163, PF163 Series	CO-8		
4 cyl	168ci	2.8L	3.000" 76.2mm	ALL	F168 Series	K-1		
6 cyl	170ci	2.8L	3.250" 82.6mm	ALL	D6170, DS6170, F170, F6170, PD170, PF170 Series	K-1		
6 cyl	184ci	3.0L	3.125" 79.4mm	ALL	D6184, DS6184 Series	K-1		
6 cyl	186ci	3.0L	3.000" 76.2mm	ALL	F186, F6186, PF186 Series	K-1		
4 cyl	193ci	3.2L	3.750" 95.3mm	ALL	D193 Series	CO-9		
4 cyl	198ci	3.2L	3.438" 87.3mm	ALL	F198 Series	CO-8		
6 cyl	199ci	3.3L	3.250" 82.6mm	ALL	D6199, F199, F6199, PD199, PF199 Series	K-1		
6 cyl	202ci	3.3L	3.125" 79.4mm	ALL	D202, D6202, DS202, DS6202, OS202, PD202 Series	K-1		
6 cyl	209ci	3.4L	3.188" 80.98mm	ALL	F209, F6209, F6209 Dynatork, PF209 Series	K-1		
6 cyl	218ci	3.6L	3.250" 82.6mm	ALL	D6218, DS6218, F214, F218, F6218, FS218, PD218, PF218 Series	K-1		
6 cyl	226ci	3.7L	3.313" 84.1mm	ALL	6226, CF6226, F226, F6226, PF226 Series	K-1		
6 cyl	227ci	3.7L	3.313" 84.1mm	ALL	F227, F6227 Series	K-1		
6 cyl	242ci	4.0L	3.425" 87mm	ALL	F242, F6242 Series	K-1		
6 cyl	244ci	4.0L	3.438" 87.3mm	ALL	A244, A6244, F244, F6244, FS244 Series	K-1		
6 cyl	245ci	4.0L	3.438" 87.3mm	ALL	F245, F6245 Series	K-1		
6 cyl	253ci	4.2L	3.625" 92.1mm	ALL	M6253 Series	CO-7		
6 cyl	271ci	4.4L	3.625" 92.1mm	ALL	38B, 40B, K6271, M271, M6271 Series	CO-7		
6 cyl	290ci	4.8L	3.750" 95.3mm	ALL	K6290, M290, M6290 Series	CO-7		
6 cyl	330ci	5.4L	4.000" 101.6mm	ALL	40B, K6330, M330, M6300, M6330, M6338 Series	CO-7		
6 cyl	363ci	5.9L	4.000" 101.6mm	ALL	K6363, M363, M6363 Series	CO-7		
6 cyl	427ci	7.0L	4.313" 109.6mm	ALL	K6427 Series	CO-7		
CUMMINS								
3 cyl	180ci	2.9L	4.016" 102mm	ALL	Cummins Diesel/Turbo-Diesel Eng. 3B, 3BT, B Series (Position Number 1)	CU-12		
4 cyl	238ci	3.9L	4.016" 102mm	ALL	Cummins Diesel/Turbo-Diesel Eng. 4-390, 4B, 4B3.9M, 4BT, 4BT3.9, 4BT3.9M, 4BTA, 4BTA3.9M, 4T-390, B Series (Position Number 1)	CU-12		

* Denotes (OHC) Repair Bearing, Check "Aluminum Overhead Cam Accessories" Section For Tool Information

** Denotes Auxiliary / Balance Shaft Bearing.

"und" Denotes Undersized ID

CAMSHAFT BEARINGS

DISPLACEMENT				YEAR	GENERAL APPLICATION DATA (ENGINE SERIES/MAKE/MODEL)	CAMSHAFT BEARING SET		
CYL.	CI./CC.	L	BORE			STD.	HI-PERF.	OHC
CUMMINS (Cont.)								
6 cyl	352ci	5.8L	4.625" 117.5mm	ALL	Cummins Diesel Eng. V6-140 Phase 5 Series F, Series D4 & D5, V352 Phase 3, 3.5, 3.5D, 5, 5F	CU-11A		
6 cyl	359ci	5.9L	4.016" 102mm	1989-08	Cummins Diesel/Turbo-Diesel Eng. 6-590, 6B, 6B5.9M, 6BT, 6BT5.9, 6BT5.9M, 6BTA, 6BTA5.9, 6BTA5.9M, 6T-590, B Series (Position Number 1) (2.253" Hsg.) (2.332" Hsg.)	CU-12 CU-14		
6 cyl	378ci	6.2L	4.625" 117.5mm	ALL	Cummins Diesel Eng. V378, VT378 Phase 5 Series F, V6-155 Phase 5 Series F	CU-11A		
4 cyl	448ci	7.3L	4.875" 123.8mm	ALL	Cummins Diesel Eng. GNHC-4, H135, HR, HR-4, HR160, HRC-4, H Series (From Serial Number 120911)	CU-10		
6 cyl	464ci	7.6L	4.437" 112.7mm	ALL	Cummins Diesel/Turbo-Diesel Eng. C160-C240, C, CS, CT, 464 Series, GNH 180	CU-5A		
8 cyl	470ci	7.7L	4.625" 117.5mm	ALL	Cummins Diesel Eng. V8-185 Phases 3, 3.5, 5 Series D, 4, 5 Series F, V470 Phases 3.5 Series D, 4, 5 Series F (2.187" Hsg.)	CU-11		
4 cyl	495ci	8.1L	5.125" 130.2mm	ALL	Cummins Diesel/Turbo-Diesel Eng. N495, N495C130, N495F, N495P130, N495PG130, NH-4, NHC-4, NT-4, NT-165, NT-180, NT-200, NT495, NTA495 Series	CU-10		
8 cyl	504ci	8.3L	4.625" 117.5mm	ALL	Cummins Diesel Eng. V8-210, V504, VT555 Phase 5 Series F (2.186" Housing Bore)	CU-11		
8 cyl	555ci	9.1L	4.625" 117.5mm	ALL	Cummins Diesel/Turbo-Diesel Eng. V555, V555C, VT225 Small Cam, VT555 Small Cam, VT555C Series (2.186" Housing Bore)	CU-11		
6 cyl	672ci	11.0L	4.875" 123.8mm	ALL	Cummins Diesel/Supercharged Diesel Eng. NH180, NH195, NHD180, NHH180, NHH195, NHH220 Series N, H, HR, HS, NH672 Small Cam Series	CU-5A		
6 cyl	672ci	11.0L	4.875" 123.8mm	1977-On	Cummins Diesel Eng. (2.500" Big Cam Series 3/32 (.0939) Wall)	CU-9		
6 cyl	743ci	12.2L	5.125" 130.2mm	ALL	Cummins Diesel/Turbocharged/Supercharged Diesel Eng. GNH220, H, HS, N, NH, NHC, NHCT, NHD, NHE, NHF, NHHR, NHHT, NHR, NHS Series NS, NT, NTA, NTC, NTE, NTF, NTO Small Cam Series	CU-5A		
6 cyl	743ci	12.2L	5.125" 130.2mm	1977-On	Cummins Diesel/Turbocharged/Supercharged Diesel Eng. 230, 250, 290, 300, 350, GNH250, N14-330E, N14-330ESP, N14-350E, N14-370E, N14-370ESP, N14-410E, N14-435E, N14-435ESP, N14-460E, N14-485E, N14-525E Series (2.500" Big Cam Series, 3/32 (.0939) Wall)	CU-9		
6 cyl	855ci	14.0L	5.500" 139.7mm	ALL	Cummins Diesel/Turbo-Diesel Eng. H, HS, N, NH, NHC, NHCT, NHD, NHE, NHF, NHHR, NHHT, NHR, NHS, NT, NTA, NTC, NTE, NTF, NTO Series Power Torque 270, 300 & 330 Small Cam Series	CU-5A		
6 cyl	855ci	14.0L	5.500" 139.7mm	1977-On	Cummins Diesel/Turbo-Diesel Eng. (2.500" Big Cam Series, 3/32 (.0939) Wall)	CU-9		
8 cyl	903ci	14.8L	5.500" 139.7mm	ALL	Cummins Diesel/Turbo-Diesel Eng. Formula 903, V903, VT903 Series	CU-13		
6 cyl	927ci	15.2L	5.500" 139.7mm	ALL	Cummins Diesel Eng. N927, Super 250, Super 270, Super 300, Super 330 Series	CU-5A		
DETROIT DIESEL								
2 cyl	106ci	1.7L	3.875" 98.4mm	ALL	Detroit Supercharged Diesel Eng. 2-53, 2-53N Series (Cam Bearing & Balance Shaft Set) (+.010 OD, Cam Bearing & Balance Shaft Set)	DE-2** DE-2R1		
2 cyl	142ci	2.3L	4.250" 108mm	ALL	Detroit Diesel Eng. 2-71 Series, (For Engines After Serial # 2A-37623) (Cam Bearing & Balance Shaft Set)	DE-1		
3 cyl	159ci	2.6L	3.875" 98.4mm	ALL	Detroit Supercharged Diesel Eng. 3-53, 3-53N Series (Cam Bearing & Balance Shaft Set) (+.010 OD, Cam Bearing & Balance Shaft Set)	DE-2A** DE-2AR1		
4 cyl	212ci	3.5L	3.875" 98.4mm	ALL	Detroit Supercharged/Turbocharged Diesel Eng. 4-53, 4-53N, 4-53T Series (Cam Bearing & Balance Shaft Set)	DE-7**		
6 cyl	318ci	5.2L	3.875" 98.4mm	ALL	Detroit Supercharged Diesel Eng. 6V-53, 6V-53E-N, 6V53T, SE Series (Cam Bearing & Balance Shaft Set) (+.010 OD, Cam Bearing & Balance Shaft Set)	DE-5** DE-5R1**		

* Denotes (OHC) Repair Bearing, Check "Aluminum Overhead Cam Accessories" Section For Tool Information

** Denotes Auxiliary / Balance Shaft Bearing.

"und" Denotes Undersized ID

CAMSHAFT BEARINGS

DISPLACEMENT		L	BORE	YEAR	GENERAL APPLICATION DATA (ENGINE SERIES/MAKE/MODEL)	CAMSHAFT BEARING SET		
CYL.	CI/CC.					STD.	HI-PERF.	OHC
DETROIT DIESEL (Cont.)								
8 cyl	500ci	8.2L	4.252" 108mm	ALL	OHV Detroit Fuel Pincher Diesel/Turbo-Diesel Eng. 8.2, 8.2N, 8.2T Series	DE-4		
EAGLE (Also see AMERICAN MOTORS / CHRYSLER)								
4 cyl	90ci 1468cc	1.5L	2.972" 75.5mm	1988-96	SOHC Mitsubishi Eng. Vin A, K, X			MIA-3* (Full Round)
4 cyl	98ci 1597cc	1.6L	3.240" 82.3mm	1989-90	DOHC Mitsubishi Eng. Vin Y (Cam Bearing Set w/ Heavy Wall, +.020 OD)			MIA-1* (1/2 Shell) MIA-2* (1/2 Shell)
4 cyl	122ci 1997cc	2.0L	3.346" 85mm	1989-98	SOHC & DOHC Mitsubishi Eng. EBG, G63B Series (Includes Turbo) Vin E, F, R, U, V (Balance Shaft Set)	MIG-3**		
4 cyl	- 2351cc	2.4L	3.405" 86.5mm	1992-96	SOHC Mitsubishi Eng. Vin G, W (Cam Bearing Set w/ Heavy Wall, +.020 OD) (Balance Shaft Set)	MIG-3**		MIA-1* (1/2 Shell) MIA-2* (1/2 Shell)
4 cyl	150ci 2460cc	2.5L	3.875" 98.5mm	1988-89	OHV AMC Eng. Vin H, Z (Special Oil Control Set w/ OD Groove No. 2, 3 Position) (Special Oil Control Set w/ OD Groove No. 2, 3 Position), (.001 Under ID)	N-7 N-7B N-7BW		
6 cyl	201ci 3301cc	3.3L	3.661" 93mm	1993-97	OHV Chrysler Eng. Vin T (Special Oil Control Set w/ OD Groove No. 2, 3 Position)	PD-28 PD-28B		
FORD MOTOR CO. (BRITISH-GERMAN, EDSEL, LINCOLN, MERCURY, MERKUR)								
4 cyl	61ci 997cc	1.0L	3.189" 81mm	1959-68	OHV Ford Europe Eng. 105E, 106E, 107E Series	F-28		
4 cyl	67ci 1098cc	1.1L	3.189" 81mm	1968-80	German Eng.	F-28		
4 cyl	73ci 1198cc	1.2L	3.189" 81mm	1961-68	Ford Europe Eng. 113E, 114E, 123E, 308E Series	F-28		
4 cyl	79.2ci 1298cc	1.3L	3.189" 81mm	1966-82	German Eng. 2735E, 3014E, 711M Series	F-28		
4 cyl	82ci 1340cc	1.3L	3.189" 81mm	1961-64	Ford Europe Eng. 109E, 123E, 124E Series	F-28		
4 cyl	91.3ci 1497cc	1.5L	3.543" 90mm	1959-72	OHV German Eng. 12M, 15M, 17M Series	F-42		
4 cyl	92ci 1498cc	1.5L	3.189" 81mm	1962-67	OHV Ford Europe Eng. 116E, 118E, 120E, 122E, 3017E, 3034E Series	F-28		
4 cyl	96.5ci 1586cc	1.6L	3.071" 78mm	1970-77	Mazda Eng.			F-41* (1/2 Shell)
4 cyl	97ci 1599cc	1.6L	3.465" 88mm	1970-84	OHV British Eng. (Auxiliary / Balance Shaft Set)	F-29 FG-29**		
4 cyl	98ci 1598cc	1.6L	3.071" 78mm	1987-94	SOHC & DOHC Mazda Eng. (Includes Turbo) Vin 6, Z			MZA-1* (Full Round)
4 cyl	98ci 1598cc	1.6L	3.150" 80mm	1981-85	SOHC Ford Eng. HS Series (Includes Turbo), Vin 2, 4, 5, 8			FA-2* (Full Round)
4 cyl	98ci 1598cc	1.6L	3.188" 80.98mm	1978-80	OHV Ford Eng. (Auxiliary / Balance Shaft Set)	F-28 FG-29**		
4 cyl	98ci 1598cc	1.6L	3.189" 81mm	1967-73	Ford Europe (British) Eng. 711M, 2737E, 3036E Series, Vin L, W	F-28		
4 cyl	104ci 1699cc	1.7L	3.543" 90mm	1962-75	OHV Ford Europe Eng. PS5 Series	F-42		

* Denotes (OHC) Repair Bearing, Check "Aluminum Overhead Cam Accessories" Section For Tool Information

** Denotes Auxiliary / Balance Shaft Bearing.

"und" Denotes Undersized ID

CAMSHAFT BEARINGS

DISPLACEMENT				YEAR	GENERAL APPLICATION DATA (ENGINE SERIES/MAKE/MODEL)	CAMSHAFT BEARING SET		
CYL.	CI./CC.	L	BORE			STD.	HI-PERF.	OHC
FORD MOTOR CO. (BRITISH-GERMAN, EDSEL, LINCOLN, MERCURY, MERKUR) (Cont.)								
4 cyl	110ci 1796cc	1.8L	3.071" 78mm	1972-79	SOHC Mazda Eng. VB, VC Series, Vin A, C			F-41* (1/2 Shell)
4 cyl	112ci 1839cc	1.8L	3.268" 83mm	1991-96	DOHC Mazda Eng. BP Series, Vin 8			MZA-1* (Full Round)
4 cyl	116ci	1.9L	3.226" 82mm	1985-96	SOHC Ford Eng. Vin 9, J			FA-1* (Full Round)
4 cyl	122ci 1970cc	2.0L	3.150" 80mm	1979-82	SOHC Mazda Eng. MA, MB Series, Vin 1, C			F-41* (1/2 Shell)
4 cyl	122ci 1989cc	2.0L	3.268" 83mm	1993-97	DOHC Mazda Eng. DE-FS Series, Vin A			MZA-2* (1/2 Shell)
4 cyl	122ci 1989cc	2.0L	3.386" 86mm	1984-87	SOHC Mazda Diesel Eng. Vin H			MZA-2* (1/2 Shell)
4 cyl	122ci 1989cc	2.0L	3.516" 89.4mm	1983-88	SOHC Ford Eng. Vin C (Special Oil Control Set w/ OD Groove) (Cam Bearing Set w/ .020 Oversize OD) (Auxiliary Shaft Set)	F-34 F-34B F-34S FG-34**		
4 cyl	122ci 1989cc	2.0L	3.578" 90.8mm	1971-74	SOHC Ford Eng. Vin X (Auxiliary Shaft Set)	F-29 FG-29**		
4 cyl	133ci 2184cc	2.2L	3.386" 86.1mm	1989-92	SOHC Mazda Eng. F2, F2-T Series (Includes Turbo), Vin C, L			MZA-2* (1/2 Shell)
4 cyl	140ci 2346cc	2.3L	3.587" 91.1mm	1985-87	SOHC Mitsubishi Turbo-Diesel Eng. 4D55-T Series, Vin E (Balance Shaft Set) (Balance Shaft Bearing w/ .173 Oversize OD) (Balance Shaft Elim)	MIG-2** MIG-2-1R MIG-2E**		
4 cyl	140ci 2300cc	2.3L	3.680" 94mm	1984-94	OHV Ford (HSC) Eng. Vin R, S, X	F-46		
4 cyl	140ci 2302cc	2.3L	3.780" 96mm	1974-97	SOHC Ford Eng. WB Series (Includes Turbo), Vin 6, A, M, R, T, W, X, Y (Special Oil Control Set w/ OD Groove) (Cam Bearing Set w/ .020 Oversize OD) (Auxiliary Shaft Set)	F-34 F-34B F-34S FG-34**		
6 cyl	144ci 2360cc	2.4L	3.500" 88.9mm	1960-66	OHV Ford Eng. Vin D, S	F-32		
4 cyl	153ci	2.5L	3.680" 93.5mm	1986-91	OHV Ford (HSC) Eng. Vin D, N	F-46		
6 cyl	156ci 2551cc	2.6L	3.543" 90mm	1970-76	OHV Ford (German) Eng. Vin U	F-31		
3 cyl	158ci 2590cc	2.6L	4.200" 107mm	1961-75	Ford Gas/Diesel Eng. 2000 Series Tractors, Vin D, G	F-43		
6 cyl	170ci 2786cc	2.8L	3.500" 88.9mm	1960-72	OHV Ford Eng. Vin F, U	F-32		
6 cyl	171ci 2792cc	2.8L	3.661" 93mm	1974-79	OHV Ford Eng. Vin Z	F-31		
6 cyl	171ci 2800cc	2.8L	3.661" 93mm	1983-86	OHV Ford Eng. Vin S (Special Oil Control Set w/ OD Groove No. 2, 3 Position)	F-47 F-47B		
6 cyl	177ci 2935cc	2.9L	3.661" 93mm	1986-92	OHV Ford Eng. Vin T, V (Special Oil Control Set w/ OD Groove No. 2, 3 Position)	F-47B		
3 cyl	175ci	2.9L	4.200" 107mm	1961-75	Ford Diesel Eng. 3000 Series Tractors, Vin D	F-43		

* Denotes (OHC) Repair Bearing, Check "Aluminum Overhead Cam Accessories" Section For Tool Information

** Denotes Auxiliary / Balance Shaft Bearing.

"und" Denotes Undersized ID

CAMSHAFT BEARINGS

DISPLACEMENT				YEAR	GENERAL APPLICATION DATA (ENGINE SERIES/MAKE/MODEL)	CAMSHAFT BEARING SET		
CYL.	CI/CC.	L	BORE			STD.	HI-PERF.	OHC
FORD MOTOR CO. (BRITISH-GERMAN, EDSEL, LINCOLN, MERCURY, MERKUR) (Cont.)								
6 cyl	182ci 2960cc	3.0L	3.425" 87mm	1993-98	SOHC Nissan Eng. VG30E Series, Vin 1, W (Cam Bearing Set, Left Bank) (Cam Bearing Set, Right Bank)			NIA-3L* (Full Round) NIA-3R* (Full Round)
6 cyl	182ci 2982cc	3.0L	3.504" 89mm	1986-08	OHV Ford (Vulcan) Eng. Vin 1, 2, U, V (ID Groove No. 4 Position)	F-48 F-48A		
3 cyl	192ci 3146cc	3.1L	4.402" 112mm	1965-72	Ford Gas/Diesel Eng. 4000 Series Tractors, Vin D, G	F-43		
6 cyl	200ci 3277cc	3.3L	3.680" 93.5mm	1963-83	OHV Ford Eng. Vin B, T, X	F-32		
3 cyl	201ci 3294cc	3.3L	4.402" 112mm	1965-72	Ford Gas/Diesel Eng. 333H, BSD333 Series Tractors	F-43		
6 cyl	215ci 3524cc	3.5L	3.563" 90.5mm	1951-53	OHV Ford Eng. Vin A	F-7		
8 cyl	221ci 3622cc	3.6L	3.063" 77.8mm	1936-48	Ford (L-Head) Eng.	F-1		
8 cyl	221ci 3622cc	3.6L	3.500" 88.9mm	1962-63	OHV Ford Eng. Vin L	F-18	FP-18 or FP-18T (Coated)	
6 cyl	223ci 3655cc	3.6L	3.625" 92.1mm	1954-64	OHV Ford Eng. Vin A, J, V (Eng's w/ Cross Drilled Camshaft Journals) (Eng's w/o Cross Drilled Camshaft Journals)	F-22 F-7		
6 cyl	232ci 3797cc	3.8L	3.811" 96.8mm	1982-87	OHV Ford Eng. Vin 3, 4, C	F-45		
6 cyl	232ci 3797cc	3.8L	3.811" 96.8mm	1988-04	OHV Ford Eng. (Includes Supercharged), Vin 4, R (Auxiliary Shaft Set) (Cam Bearings & Aux. Shaft Kit)	F-52 FG-51** F-38		
4 cyl	233ci 3819cc	3.8L	4.200" 107mm	1965-68	Ford Gas/Diesel Eng. 5000 Series Tractors	F-44		
8 cyl	239ci 3924cc	3.9L	3.188" 80.98mm	1939-53	Ford (L-Head) Eng. Vin B	F-1		
8 cyl	239ci 3917cc	3.9L	3.500" 88.9mm	1954-55	OHV Ford Eng. Vin U (Cam Bearing w/ Grooved No. 3 Journal) (Cam w/ Cross-Drilled No. 3 Journal)	F-9A F-9B		
6 cyl	240ci 3933cc	3.9L	4.000" 101.6mm	1965-76	OHV Ford Eng. Vin 1, A, B, E, J, V	F-23A		
6 cyl	245ci 4015cc	4.0L	3.953" 100.4mm	1990-00	OHV Ford Eng. Vin X (Cam Bearing Set w/ Special Wide No. 4 Position)	F-50 F-50A		
6 cyl	245ci 4015cc	4.0L	3.953" 100.4mm	1997-11	SOHC Ford Eng. Vin E, K (Auxiliary Shaft Set) (Balance Shaft Drive Gear Bushing)	FG-53** FG-1-1**		FA-6* (1/2 Shell)
6 cyl	250ci 4097cc	4.1L	3.680" 93.5mm	1969-80	OHV Ford Eng. Vin C, L	F-32		
8 cyl	255ci 4186cc	4.2L	3.188" 80.98mm	1948-54	Ford (L-Head) Eng.	F-1		
8 cyl	255ci	4.2L	3.680" 93.5mm	1980-82	OHV Ford Eng. Vin D	F-18	FP-18 or FP-18T (Coated)	
4 cyl	256ci 4195cc	4.2L	4.400" 112mm	1968-90	Ford Gas/Diesel/Turbo Diesel Eng. 5000 Series Tractors, Vin D, G	F-44		

* Denotes (OHC) Repair Bearing, Check "Aluminum Overhead Cam Accessories" Section For Tool Information

** Denotes Auxiliary / Balance Shaft Bearing.

"und" Denotes Undersized ID

CAMSHAFT BEARINGS

DISPLACEMENT				YEAR	GENERAL APPLICATION DATA (ENGINE SERIES/MAKE/MODEL)	CAMSHAFT BEARING SET		
CYL.	CI./CC.	L	BORE			STD.	HI-PERF.	OHC
FORD MOTOR CO. (BRITISH-GERMAN, EDSEL, LINCOLN, MERCURY, MERKUR) (Cont.)								
6 cyl	256ci 4196cc	4.2L	3.811" 96.8mm	1997-08	OHV Ford (Triton) Eng. Vin 2 (Auxiliary Shaft Set) (Cam Bearings & Aux. Shaft Kit)	F-52 FG-51** F-38		
8 cyl	256ci 4196cc	4.2L	3.625" 92.1mm	1954-55	OHV Ford Eng. Vin P (Cam Bearing w/ Grooved No. 3 Journal) (Cam w/ Cross-Drilled No. 3 Journal)	F-9A F-9B		
8 cyl	260ci 4261cc	4.3L	3.800" 96.5mm	1962-65	OHV Ford Eng. Vin F	F-18	FP-18 or FP-18T (Coated)	
6 cyl	262ci 4294cc	4.3L	3.719" 94.5mm	1961-64	OHV Ford Eng. Vin B (Engs w/ Cross Drilled Camshaft Journals) (Engs w/o Cross Drilled Camshaft Journals)	F-22 F-7		
8 cyl	272ci 4458cc	4.4L	3.625" 92.1mm	1955-58	OHV Ford Eng. Vin B, M, U (Cam Bearing w/ Grooved No. 3 Journal) (Cam w/ Cross-Drilled No. 3 Journal)	F-9A F-9B		
8 cyl	281ci 4605cc	4.6L	3.551" 90.2mm	1991-13	SOHC Ford (Triton) Eng. Vin 6, 9, V, W, X (1 Cam Set Per Cylinder Head)			FA-3* (1/2 Shell)
8 cyl	281ci 4605cc	4.6L	3.551" 90.2mm	1993-96	DOHC Ford (InTech) Eng. Vin V (To Early 1996), (1 Cam Set Per Cylinder Head)			FA-4* (1/2 Shell)
8 cyl	281ci 4605cc	4.6L	3.551" 90.2mm	1996-05	DOHC Ford (InTech) Eng. Vin H, R, V, Y (From Late 1996), (1 Cam Set Per Cylinder Head)			FA-5* (1/2 Shell)
8 cyl	289ci 4727cc	4.7L	4.000" 101.6mm	1963-69	OHV Ford Eng. Vin A, C, D, K, N	F-18	FP-18 or FP-18T (Coated)	
8 cyl	292ci 4786cc	4.8L	3.750" 95.3mm	1955-65	OHV Ford Eng. Vin C, D, M, P, W (Cam Bearing w/ Grooved No. 3 Journal) (Cam w/ Cross-Drilled No. 3 Journal)	F-9A F-9B		
6 cyl	300ci 4917cc	4.9L	4.000" 101.6mm	1965-85	OHV Ford Eng. Vin 9, B, E, K, Y (To Early 1985) (Special Oil Control Set w/ OD Groove)	F-23A F-23B		
6 cyl	300ci	4.9L	4.000" 101.6mm	1985-96	OHV Ford Eng. Vin 9, Y, Z (From Late 1985) (Special Oil Control Set w/ OD Groove)	F-49 F-49B		
8 cyl	302ci	5.0L	3.625" 92.1mm	1956-63	OHV Ford Eng.	F-12		
8 cyl	302ci 4949cc	5.0L	4.000" 101.6mm	1968-01	OHV Ford Eng. Vin B, D, E, F, G, J, M, N, P, T	F-18	FP-18 or FP-18T (Coated)	
8 cyl	302ci	5.0L	4.000" 101.6mm	ALL	SVO Ford (Performance) Eng. (2.204" Hsg., Stepped Cam) (+.010 OD) (R302 Block w/ 2.204" Hsg., Common Journal Size Cam)		351HP or 351HPT (Coated) 351RHP or 351RHPT (Coated)	
8 cyl	312ci 5114cc	5.1L	3.800" 96.5mm	1956-60	OHV Ford Eng. Vin D, E, F, L, P (Cam Grooved in #3 Journal)	F-9A		
8 cyl	330ci	5.4L	3.875" 98.4mm	1964-78	OHV Ford (MD-HD) Eng.	F-33	FP-33 or FP-33T (Coated)	
8 cyl	330ci	5.4L	3.551" 90.2mm	2004-13	SOHC Ford (3 Valve Per Chamber) Eng. Vin 5, V (Cam Bearing Set, Left Bank) (Cam Bearing Set, Right Bank)			FA-13L* (1/2 Shell) FA-13R* (1/2 Shell)

* Denotes (OHC) Repair Bearing, Check "Aluminum Overhead Cam Accessories" Section For Tool Information

** Denotes Auxiliary / Balance Shaft Bearing.

"und" Denotes Undersized ID

CAMSHAFT BEARINGS

DISPLACEMENT				YEAR	GENERAL APPLICATION DATA (ENGINE SERIES/MAKE/MODEL)	CAMSHAFT BEARING SET		
CYL.	CI/CC.	L	BORE			STD.	HI-PERF.	OHC
FORD MOTOR CO. (BRITISH-GERMAN, EDSEL, LINCOLN, MERCURY, MERKUR) (Cont.)								
8 cyl	332ci	5.4L	3.800" 96.5mm	1956-64	OHV Ford (MD-HD) Eng.	F-12		
8 cyl	332ci 5441cc	5.4L	4.000" 101.6mm	1958-59	OHV Ford Eng. Vin B, G	F-33	FP-33 or FP-33T (Coated)	
8 cyl	351ci 5752cc	5.8L	4.000" 101.6mm	1969-97	OHV Ford (Windsor) Eng. Vin C, G, H, M, R, W	F-18	FP-18 or FP-18T (Coated)	
8 cyl	351ci 5752cc	5.8L	4.000" 101.6mm	1970-82	OHV Ford (Cleveland) Eng. Vin H, M, Q, R (70-74); OHV Ford (Modified) Eng. Vin G, H, (75-82)	F-26	FP-26 or FP-26T (Coated)	
8 cyl	351ci	5.8L	4.000" 101.6mm	ALL	SVO Ford (Performance) Eng. (2.204" Cam Housings) (+0.010 OD) (R302 Block w/ 2.204" Hsg., Common Journal Size Cam)		351HP or 351HPT (Coated) 351HP-R1 351RHP or 351RHPT (Coated)	
8 cyl	352ci 5769cc	5.8L	4.000" 101.6mm	1957-67	OHV Ford Eng. Vin D, H, R, X, Y	F-33	FP-33 or FP-33T (Coated)	
6 cyl	359ci	5.9L	4.016" 102.1mm	1993-99	Cummins Diesel/Turbo-Diesel Eng. FD1060 Series, Vin C	CU-12		
8 cyl	360ci 5899cc	5.9L	4.050" 102.9mm	1968-77	OHV Ford Eng. Vin Y	F-33	FP-33 or FP-33T (Coated)	
8 cyl	361ci 5917cc	5.9L	4.050" 102.9mm	1958-78	OHV Ford Eng. Vin W	F-33	FP-33 or FP-33T (Coated)	
8 cyl	363ci	6.0L	3.740" 95mm	2004-10	OHV Ford/International (Power-Stroke) Turbo Diesel Eng. VT365 Series, Vin P	IN-21		
8 cyl	368ci 6032cc	6.0L	4.000" 101.6mm	1956-57	OHV Ford Eng.	F-11		
8 cyl	370ci	6.1L	4.046" 102.8mm	1979-91	OHV Ford Eng. Vin 7, C, H (Special Bearing Set w/ Wide No. 1-5 Position) (+.005 OD) (+.010 OD) (+.015 OD) (+.020 OD)	F-30 F-30R1 F-57 F-30R2	FP-30 or FP-30T (Coated) FP-30AT (Coated) FP-30R	
8 cyl	390ci 6391cc	6.4L	4.050" 102.9mm	1961-77	OHV Ford Eng. Vin 9, H, M, P, Q, R, S, X, Y, Z	F-33	FP-33 or FP-33T (Coated)	
8 cyl	391ci	6.4L	3.860" 98mm	2008-10	OHV Ford (Power-Stroke) Turbo Diesel Eng. Vin R	IN-21		
8 cyl	391ci	6.4L	4.050" 102.9mm	1964-78	OHV Ford (MD-HD) Eng.	F-33	FP-33 or FP-33T (Coated)	
8 cyl	400ci 6555cc	6.6L	4.000" 101.6mm	1971-82	OHV Ford Eng. Vin S, Z	F-26	FP-26 or FP-26T (Coated)	
6 cyl	401ci	6.6L	4.400" 111.8mm	1986-95	Ford (Brazilian) Turbo-Diesel Eng.	F-55		
6 cyl	401ci	6.6L	4.400" 111.8mm	1986-95	OHV Ford Diesel/Turbo-Diesel Eng. 401D, 401TD Series, Vin P	F-44		

* Denotes (OHC) Repair Bearing, Check "Aluminum Overhead Cam Accessories" Section For Tool Information

** Denotes Auxiliary / Balance Shaft Bearing.

"und" Denotes Undersized ID

CAMSHAFT BEARINGS

DISPLACEMENT				YEAR	GENERAL APPLICATION DATA (ENGINE SERIES/MAKE/MODEL)	CAMSHAFT BEARING SET		
CYL.	CI./CC.	L	BORE			STD.	HI-PERF.	OHC
FORD MOTOR CO. (BRITISH-GERMAN, EDSEL, LINCOLN, MERCURY, MERKUR) (Cont.)								
8 cyl	401ci	6.6L	4.125" 104.8mm	1958-76	OHV (HD) Ford Eng.	F-16		
8 cyl	406ci 6654cc	6.6L	4.130" 104.9mm	1962-63	OHV Ford Eng. Vin B, G	F-33	FP-33 or FP-33T (Coated)	
8 cyl	410ci 6720cc	6.7L	4.050" 102.9mm	1966-67	OHV Ford Eng. Vin M	F-33	FP-33 or FP-33T (Coated)	
10 cyl	415ci 6760cc	6.8L	3.552" 90.2mm	1997-13	SOHC (2-Valve) Ford (Triton) Eng. Vin S (Cam Bearing Set, Left Bank) (Cam Bearing Set, Right Bank)			FA-14L* (1/2 Shell) FA-14R* (1/2 Shell)
8 cyl	420ci	6.9L	4.000" 101.6mm	1983-87	OHV IHC-Navistar Diesel Eng. Vin 1 (+.020 OD, -.005 Journal)	IN-17 IN-17R2		
8 cyl	427ci 6997cc	7.0L	4.233" 107.5mm	1963-65	OHV Ford Eng. Vin L, M, Q, R	F-33	FP-33 or FP-33T (Coated)	
8 cyl	427ci 6997cc	7.0L	4.233" 107.5mm	1966-69	OHV (Side Oiler/Wedge-Head) Ford Eng. Vin L, M, R, W	F-24		
8 cyl	428ci 7014cc	7.0L	4.130" 104.9mm	1965-70	OHV Ford Eng. Vin P, Q, R	F-33	FP-33 or FP-33T (Coated)	
8 cyl	429ci 7030cc	7.0L	4.360" 110.7mm	1968-98	OHV Ford Eng. Vin 8, C, J, K, N, P, R, Z (Special Bearing Set w/ Wide No. 1-5 Position) (+.005 OD) (+.010 OD) (+.015 OD) (+.020 OD)	F-30 F-30R1 F-57 F-30R2	FP-30 or FP-30T (Coated) FP-30AT (Coated) FP-30R	
8 cyl	430ci 7048cc	7.0L	4.300" 109.2mm	1958-65	OHV Ford Eng. Vin H, J, K, L, M, N	F-19		
8 cyl	445ci	7.3L	4.110" 104.4mm	1988-03	OHV (Direct/Indirect Injection) IHC-Navistar Diesel/Turbo-Diesel Eng. Vin C, F, K, M (+.020 OD, -.005 Journal)	IN-17 IN-17R2		
8 cyl	460ci 7539cc	7.5L	4.360" 110.7mm	1968-98	OHV Ford Eng. Vin A, C, G, J, L (Special Bearing Set w/ Wide No. 1-5 Position) (+.005 OD) (+.010 OD) (+.015 OD) (+.020 OD)	F-30 F-30R1 F-57 F-30R2	FP-30 or FP-30T (Coated) FP-30AT (Coated) FP-30R	
8 cyl	462ci 7582cc	7.6L	4.380" 111.3mm	1966-68	OHV Ford Eng. Vin 7, G	F-19		
6 cyl	464ci	7.6L	4.438" 111.3mm	ALL	OHV Cummins Diesel/Turbo-Diesel Eng.	CU-5A		
6 cyl	474ci	7.8L	4.400" 112mm	1986-95	OHV Ford Turbo-Diesel Eng. Vin A	F-44		
6 cyl	474ci	7.8L	4.400" 111.8mm	1987-95	Ford (Brazilian) Turbo-Diesel Eng.	F-55		
8 cyl	475ci	7.8L	4.500" 114.3mm	1973-79	OHV (HD) Ford Eng.	F-16		

* Denotes (OHC) Repair Bearing, Check "Aluminum Overhead Cam Accessories" Section For Tool Information

** Denotes Auxiliary / Balance Shaft Bearing.

"und" Denotes Undersized ID

CAMSHAFT BEARINGS

CYL.	DISPLACEMENT			YEAR	GENERAL APPLICATION DATA (ENGINE SERIES/MAKE/MODEL)	CAMSHAFT BEARING SET		
	CI/CC.	L	BORE			STD.	HI-PERF.	OHC
FORD MOTOR CO. (BRITISH-GERMAN, EDSEL, LINCOLN, MERCURY, MERKUR) (Cont.)								
8 cyl	477ci	7.8L	4.500" 114.3mm	1958-81	OHV (HD) Ford Eng.	F-16		
8 cyl	501ci	8.2L	4.252" 108mm	1980-87	OHV (Fuel Pincher) Detroit Diesel/Turbo-Diesel Eng. Vin N	DE-4		
8 cyl	522ci	8.5L	4.500" 114.3mm	1968-75	OHV Caterpillar Diesel Eng.	CAT-2		
6 cyl	525ci	8.6L	4.500" 114.3mm	1965-69	OHV Caterpillar Turbo-Diesel Eng. (No. 1 Position, OE#9M5744) (No. 2, 3, 4, 5 Position, OE#7M4046) (Balance Shaft Bearings: No. 1, 2, 5, 6 Position, OE#9M5239) (Balance Shaft Bearings: No. 3, 4 Position, OE#9M5238)	CAT-2-1 CAT-2-2 CAT-2-5 CAT-2-6		
8 cyl	534ci	8.8L	4.500" 114.3mm	1958-81	OHV (HD) Ford Eng.	F-16		
8 cyl	555ci	9.1L	4.625" 117.5mm	1973-79	OHV Cummins Diesel Eng. V55C, V555 Series (2.186" Housing Bore)	CU-11		
8 cyl	573ci	9.4L	4.500" 114.3mm	1968-75	OHV Caterpillar Diesel Eng. V200 Series	CAT-2		
8 cyl	636ci	10.4L	4.500" 114.3mm	1968-72	OHV Caterpillar Diesel Eng. V225 Series	CAT-2		
6 cyl	638ci	10.5L	4.750" 120.7mm	1988-89	OHV Caterpillar Turbo-Diesel Eng. (Balance Shaft Set)	CAT-6 CAT-7**		
6 cyl	672ci	11.0L	4.875" 123.8mm	1964-65	OHV Cummins Diesel Eng.	CU-5A		
6 cyl	743ci	12.2L	5.125" 130.2mm	1964-69	OHV Cummins Diesel Eng.	CU-5A		
6 cyl	855ci	14.0L	5.500" 139.7mm	1964-72	OHV Cummins Diesel Eng.	CU-5A		
6 cyl	855ci	14.0L	5.500" 139.7mm	1964-78	OHV Cummins Turbo-Diesel Eng.	CU-9		
6 cyl	927ci	15.2L	5.500" 139.7mm	1974-83	OHV Cummins Diesel Eng.	CU-5A		
FORD TRACTOR CO. (Also see FORD MOTOR CO.)								
3 cyl	158ci 2590cc	2.6L	4.200" 106.7mm	1965-90	Gas/Diesel/LPG Eng.	F-43		
3 cyl	175ci	2.9L	4.200" 106.7mm	1965-90	Gas/Diesel/LPG Eng.	F-43		
3 cyl	183ci 2999cc	3.0L	4.200" 106.7mm	1965-90	Diesel Eng.	F-43		
3 cyl	192ci 3146cc	3.1L	4.406" 112mm	1965-69	Gas/Diesel/LPG Eng.	F-43		
3 cyl	201ci 3294cc	3.3L	4.406" 112mm	1965-81	Gas/Diesel/LPG Eng.	F-43		
6 cyl	223ci	3.7L	3.625" 92.1mm	1961-66	Gas/LPG Eng.	F-7		
4 cyl	233ci 3819cc	3.8L	4.200" 106.7mm	1965-68	Gas/Diesel/LPG Eng.	F-44		
6 cyl	242ci	4.0L	3.625" 92.1mm	1961-66	Diesel Eng.	F-7		
4 cyl	256ci 4195cc	4.2L	4.406" 112mm	1968-90	Gas/Diesel/Turbo-Diesel Eng.	F-44		
6 cyl	401ci	6.6L	4.406" 112mm	1969-90	Diesel/Turbo-Diesel Eng.	F-44		

* Denotes (OHC) Repair Bearing, Check "Aluminum Overhead Cam Accessories" Section For Tool Information

** Denotes Auxiliary / Balance Shaft Bearing.

"und" Denotes Undersized ID

CAMSHAFT BEARINGS

DISPLACEMENT				YEAR	GENERAL APPLICATION DATA (ENGINE SERIES/MAKE/MODEL)	CAMSHAFT BEARING SET		
CYL.	CI./CC.	L	BORE			STD.	HI-PERF.	OHC
FORD TRACTOR CO. (Also see FORD MOTOR CO.) (Cont.)								
6 cyl	474ci	7.8L	4.400" 111.8mm	1987-97	(Brazilian) Turbocharged Diesel Eng.	F-55		
GENERAL MOTORS (BUICK, CADILLAC, CHEVROLET, GEO, GMC, OLDSMOBILE, PONTIAC, SATURN)								
4 cyl	79ci 1295cc	1.3L	2.913" 74mm	1992-01	SOHC Suzuki Eng. G13A Series, Vin 2, 3, 9			SA-1* (Full Round)
4 cyl	92ci 1471cc	1.5L	3.031" 77mm	1985-89	SOHC Isuzu Eng. 4XC1, 4XC1-T Series (Includes Turbo), Vin 7, 9, K (Auxiliary Shaft Set)	CHG-14**		
4 cyl	111ci 1817cc	1.8L	3.307" 84mm	1972-82	SOHC Isuzu Eng. G180Z Series, Vin N (Cam Bearing Set w/ Heavy Wall, +.020 OD) (Auxiliary / Balance Shaft Set)	CHG-14**		MIA-1* (1/2 Shell) MIA-2* (1/2 Shell)
4 cyl	112ci 1835cc	1.8L	3.504" 89mm	1982	OHV Chevrolet Eng. Vin G (.002 Under ID)	CH-19 CH-19X2		
4 cyl	116ci 1901cc	1.9L	3.230" 82mm	1991-02	SOHC Chevrolet (Saturn) Eng. Vin 8, 9			GMA-1* (Full Round)
4 cyl	116ci 1901cc	1.9L	3.230" 82mm	1991-02	DOHC Chevrolet (Saturn) Eng. Vin 7			GMA-2* (1/2 Shell)
4 cyl	119ci 1949cc	1.9L	3.425" 87mm	1982-85	SOHC Isuzu Eng. G200Z Series, Vin A (Cam Bearing Set w/ Heavy Wall, +.020 OD) (Auxiliary / Balance Shaft Set)	CHG-14**		MIA-1* (1/2 Shell) MIA-2* (1/2 Shell)
4 cyl	121ci 1989cc	2.0L	3.504" 89mm	1983-89	OHV Chevrolet Eng. Vin 1, B, P, Y (.002 Under ID)	CH-19 CH-19X2		
4 cyl	122ci 1999cc	2.0L	3.500" 89mm	1975-76	DOHC Chevrolet (Cosworth) Eng. Vin E, O	CH-13		
4 cyl	134ci 2198cc	2.2L	3.386" 86mm	2000-11	DOHC Chevrolet (Ecotec) Eng. LAP, LE8, L61 Series. Vin 5, 6, B, D, F, H, W (Balance Shaft Set)	CHG-24**		
4 cyl	134ci 2238cc	2.2L	3.465" 88mm	1981-82	OHV Isuzu Diesel Eng. C223 Series, Vin S	IZ-2		
4 cyl	134ci 2238cc	2.2L	3.465" 88mm	1983-85	OHV Isuzu Diesel Eng. C223 Series, Vin S	IZ-3		
4 cyl	134ci 2189cc	2.2L	3.500" 89mm	1990-03	OHV Chevrolet (Vortec) Eng. Vin 4, 5, G, H (.002 Under ID)	CH-19 CH-19X2		
4 cyl	140ci 2294cc	2.3L	3.500" 88.9mm	1971-77	SOHC Chevrolet Eng. Vin A, B	CH-13		
4 cyl	151ci 2474cc	2.5L	4.000" 101.6mm	1977-93	OHV Pontiac Eng. Vin 1, 2, 5, 9, A, E, F, R, V (.001 Under ID)	CH-16 CH-16W		
4 cyl	151ci 2474cc	2.5L	4.000" 101.6mm	1985-91	OHV Pontiac Eng. Vin U	CH-20		
4 cyl	153ci 2507cc	2.5L	3.875" 98.4mm	1962-70	OHV Chevrolet Eng. Vin AA, CA, OH	CH-6		
4 cyl	169ci 2770cc	2.8L	3.661" 93mm	2004-06	DOHC Chevrolet (Vortec) Eng. Vin 8 (Balance Shaft Set)	CHG-23**		
6 cyl	173ci 2835cc	2.8L	3.504" 89mm	1980-93	OHV Chevrolet Eng. Vin 1, 7, 9, B, L, R, S, W, X, Z (Special Bearing Set w/ Wide No. 2, 3 Position) (Oversize OD - See Set Contents) (Oversize OD)	CH-18 CH-18A CH-18RS CH-18R8		

* Denotes (OHC) Repair Bearing, Check "Aluminum Overhead Cam Accessories" Section For Tool Information

** Denotes Auxiliary / Balance Shaft Bearing.

"und" Denotes Undersized ID

CAMSHAFT BEARINGS

DISPLACEMENT				YEAR	GENERAL APPLICATION DATA (ENGINE SERIES/MAKE/MODEL)	CAMSHAFT BEARING SET		
CYL.	CI/CC.	L	BORE			STD.	HI-PERF.	OHC
GENERAL MOTORS (BUICK, CADILLAC, CHEVROLET, GEO, GMC, OLDSMOBILE, PONTIAC, SATURN) (Cont.)								
4 cyl	181ci	3.0L	4.000" 101.6mm	1982	OHV GMC Eng. (Marine & Industrial) (.001 Under ID)	CH-16 CH-16W		
6 cyl	181ci	3.0L	3.800" 96.5mm	1982-85	OHV Buick Eng. (1st Design w/ 14 Bolt Oil Pan), Vin E (Oil Control Set w/ Opt. Groove Design, #1 Position)	B-12 B-12B		
6 cyl	181ci	3.0L	3.800" 96.5mm	1985-88	OHV Buick Eng. (2nd Design w/ 20 Bolt Oil Pan), Vin L (+.025 OD)	B-13 B-13R	BP-13 or BP-13T (Coated)	
6 cyl	189ci 3136cc	3.1L	3.504" 89mm	1988-05	OHV Chevrolet Eng. (Includes Turbo), Vin D, J, M, T, V, W (Special Bearing Set w/ Wide No. 2, 3 Position) (Oversize OD - See Set Contents) (Oversize OD)	CH-18 CH-18A CH-18RS CH-18R8		
6 cyl	194ci 3180cc	3.2L	3.563" 90.5mm	1962-67	OHV Chevrolet Eng.	CH-7		
4 cyl	195ci 3196cc	3.2L	4.063" 103.2mm	1961-62	OHV Pontiac Eng.	P-3	PP-3 or PP-3T (Coated)	
4 cyl	195ci 3196cc	3.2L	4.063" 103.2mm	1963	OHV Pontiac Eng. (+.010 OD)	P-4 P-4R1	PP-4 or PP-4T (Coated)	
6 cyl	196ci	3.2L	3.500" 88.9mm	1978-79	OHV Buick Eng. Vin C (Oil Control Set w/ Opt. Groove Design, #1 Position)	B-12 B-12B		
6 cyl	198ci 3245cc	3.2L	3.625" 92.1mm	1962-63	OHV Buick Eng. 6I, JL, JZ Series	B-6		
6 cyl	200ci	3.3L	3.500" 88.9mm	1978-79	OHV Chevrolet Eng. Vin M (.001 Under ID)	CH-17 CH-17X	CHP-17 or CHP-17T (Coated)	
6 cyl	204ci	3.3L	3.701" 94mm	1989-93	OHV Buick Eng. Vin N (+.025 OD)	B-13 B-13R	BP-13 or BP-13T (Coated)	
6 cyl	207ci 3393cc	3.4L	3.622" 92mm	1991-97	DOHC Chevrolet Eng. Vin X (Auxiliary Shaft Set)	CHG-22**		
6 cyl	207ci 3393cc	3.4L	3.622" 92mm	1993-09	OHV Chevrolet Eng. Vin E, F, S (Special Bearing Set w/ Wide No. 2, 3 Position) (Oversize OD - See Set Contents) (Oversize OD)	CH-18 CH-18A CH-18RS CH-18R8		
5 cyl	211ci 3460cc	3.5L	3.661" 93mm	2004-06	DOHC Chevrolet (Vortec) Eng. Vin 6 (Balance Shaft Set)	CHG-23**		
6 cyl	213ci	3.5L	3.700" 93.98mm	2004-07	OHV Chevrolet Eng. Vin 8, L	CH-24		
6 cyl	214ci 3473cc	3.5L	3.524" 89.5mm	1999-02	DOHC Oldsmobile Eng. Vin H (Balance Shaft Set)	OG-1**		
6 cyl	215ci 3524cc	3.5L	3.750" 95.3mm	1964-65	OHV Pontiac Eng.	CH-7		
8 cyl	215ci 3528cc	3.5L	3.500" 88.9mm	1961-63	OHV Buick Eng. (Includes Turbo)	B-11		
6 cyl	216ci 3548cc	3.5L	3.500" 88.9mm	1937-53	OHV Chevrolet Eng.	CH-2		

* Denotes (OHC) Repair Bearing, Check "Aluminum Overhead Cam Accessories" Section For Tool Information

** Denotes Auxiliary / Balance Shaft Bearing.

"und" Denotes Undersized ID

CAMSHAFT BEARINGS

DISPLACEMENT				YEAR	GENERAL APPLICATION DATA (ENGINE SERIES/MAKE/MODEL)	CAMSHAFT BEARING SET		
CYL.	CI./CC.	L	BORE			STD.	HI-PERF.	OHC
GENERAL MOTORS (BUICK, CADILLAC, CHEVROLET, GEO, GMC, OLDSMOBILE, PONTIAC, SATURN) (Cont.)								
5 cyl	223ci 3654cc	3.7L	3.760" 95.5mm	2007-12	DOHC Chevrolet Eng. Vin E (Balance Shaft Set)	CHG-23**		
6 cyl	224ci	3.7L	3.563" 90.5mm	1940-47	OHV Eng.	CH-2		
6 cyl	225ci 3687cc	3.7L	3.750" 95.3mm	1964-67	OHV Buick Eng.	B-6		
6 cyl	228ci 3737cc	3.7L	3.563" 90.5mm	1939-53	OHV GMC Eng.	CH-2		
6 cyl	229ci	3.8L	3.736" 95mm	1980-84	OHV Buick/Chevrolet Eng. Vin 9, K (.001 Under ID)	CH-17 CH-17X	CHP-17 or CHP-17T (Coated)	
6 cyl	230ci 3769cc	3.8L	3.875" 98.4mm	1963-70	OHV Chevrolet Eng. Vin S	CH-7		
6 cyl	231ci 3800cc	3.8L	3.800" 96.5mm	1975-85	OHV Buick Eng. (Includes Turbo), Vin 2, 3, 8, 9, A, C, G (1st Design w/ 14 Bolt Oil Pan) (Special Oil Control Set w/ OD Groove No. 1 Position)	B-12 B-12B		
6 cyl	231ci 3800cc	3.8L	3.800" 96.5mm	1985-95	OHV Buick Eng. (Includes Supercharged), Vin 1, 3, 7, 9, A, B, C, L (2nd Design w/ 20 Bolt Oil Pan) (+.025 OD)	B-13 B-13R	BP-13 or BP-13T (Coated)	
6 cyl	231ci 3800cc	3.8L	3.800" 96.5mm	1995-09	OHV Buick Eng. (Includes Supercharged), Vin 1, 2, 4, K (+.025 OD)	B-14 B-14R		
6 cyl	235ci 3852cc	3.8L	3.563" 90.5mm	1949-54	OHV Chevrolet Eng. (Early 1954 w/ 2.029" Diameter Number 1 Camshaft Journal, Small Journals)	CH-2		
6 cyl	235ci 3852cc	3.8L	3.563" 90.5mm	1954-63	OHV Chevrolet Eng. (Late 1954 w/ 2.154" Diameter Number 1 Camshaft Journal, Large Journals)	CH-3		
6 cyl	236ci	3.9L	3.625" 92.1mm	1942-46	OHV GMC Eng.	CH-2		
6 cyl	237ci 3880cc	3.9L	3.898" 99mm	2006-11	OHV Chevrolet Eng. LGD, LZG Series, Vin 1, 3, M, R, W	CH-24		
6 cyl	248ci 4065cc	4.1L	3.719" 94.5mm	1939-55	OHV GMC Eng.	CH-2		
6 cyl	250ci 4097cc	4.1L	3.875" 98.4mm	1965-70	OHV Chevrolet Eng. Vin N, P, S	CH-7		
6 cyl	250ci 4097cc	4.1L	3.875" 98.4mm	1971-84	OHV Chevrolet Eng. Vin C, D, L, N, Q, S (Special Oil Control Set w/ OD Groove)	CH-11 CH-11B		
8 cyl	250ci 4097cc	4.1L	3.465" 88mm	1982-88	OHV Cadillac Eng. Vin 7, 8 (Special Bearing Set w/ Wide No. 5 Position)	C-4 C-4A		
6 cyl	252ci	4.1L	3.965" 100.7mm	1980-84	OHV Buick Eng. Vin 4 (1st Design w/ 14 Bolt Oil Pan) (Special Oil Control Set w/ OD Groove No. 1 Position)	B-12 B-12B		
6 cyl	256ci	4.2L	3.781" 96mm	1940-46	OHV Eng.	CH-2		
6 cyl	260ci	4.3L	4.057" 103mm	1982-85	OHV Oldsmobile Diesel Eng. Vin T, V	O-8		
8 cyl	260ci	4.3L	3.500" 88.9mm	1975-76	OHV Oldsmobile Eng. Vin F (Special Oil Control Set w/ OD Groove)	O-6 O-6B		
8 cyl	260ci	4.3L	3.500" 88.9mm	1977-82	OHV Oldsmobile Gas/Diesel Eng. Vin 8, F, P	O-7		

* Denotes (OHC) Repair Bearing, Check "Aluminum Overhead Cam Accessories" Section For Tool Information

** Denotes Auxiliary / Balance Shaft Bearing.

"und" Denotes Undersized ID

CAMSHAFT BEARINGS

DISPLACEMENT				YEAR	GENERAL APPLICATION DATA (ENGINE SERIES/MAKE/MODEL)	CAMSHAFT BEARING SET		
CYL.	CI/CC.	L	BORE			STD.	HI-PERF.	OHC
GENERAL MOTORS (BUICK, CADILLAC, CHEVROLET, GEO, GMC, OLDSMOBILE, PONTIAC, SATURN) (Cont.)								
6 cyl	261ci 4278cc	4.3L	3.750" 95.3mm	1954	OHV Chevrolet Eng. (Early 1954 w/ 2.029" Diameter Number 1 Camshaft Journal, Small Journals)	CH-2		
6 cyl	261ci 4278cc	4.3L	3.750" 95.3mm	1954-62	OHV Chevrolet Eng. (Late 1954 w/ 2.154" Diameter Number 1 Camshaft Journal, Large Journals)	CH-3		
6 cyl	262ci 4294cc	4.3L	4.000" 101.6mm	1985-02	OHV Chevrolet (Vortec) Eng. (Includes Turbo), Vin B, N, W, X, Z (Engines Stamped With Identification Number Located On Front Of Block Starting With W) (.001 Under ID) (Balance Shaft Rear Bearing, Includes Tool) (Cam Bearing & Balance Shaft Kit)	CH-17 CH-17X CHG-15A** CH-17G	CHP-17 or CHP-17T (Coated)	
6 cyl	262ci 4294cc	4.3L	4.000" 101.6mm	1992-10	OHV Chevrolet (Vortec) Eng. (Includes Turbo), (Engines Stamped With Identification Number Located On Front Of Block Starting With T) (.001 Under ID) (Balance Shaft Rear Bearing, Includes Tool) (Cam Bearing & Balance Shaft Kit)	CH-21 CH-21X CHG-15A** CH-21G	CHP-21 or CHP-21T (Coated)	
8 cyl	262ci	4.3L	3.670" 93.2mm	1975-76	OHV Chevrolet Eng. Vin G (+.010 Oversize, 2.030 Hsg, .0795 Wall) (+.010 OD, 2.030" Hsg.) (+.010 OD, 2.030" Hsg.) (+.020 OD, 2.040" Hsg.) (+.020 OD, 2.040" Hsg.) (+.030 OD, 2.050" Hsg.) (+.030 OD, 2.050" Hsg.) (+.040 OD, 2.060" Hsg.) (+.040 OD, 2.060" Hsg.) (.001 Under ID)	CH-8 CH-4A CH-8W	CHP-8 or CHP-8T (Coated) CHP-8R1 or CHP-8R1T (Coated) CHP-8R2 or CHP-8R2T (Coated) CHP-8R3 or CHP-8R3T (Coated) CHP-8R4 or CHP-8R4T (Coated)	
8 cyl	265ci	4.3L	3.736" 93.2mm	1994-96	OHV Chevrolet (Vortec) Eng. Vin W (+.010 Oversize, 2.030 Hsg, .0795 Wall) (+.010 OD, 2.030" Hsg.) (+.010 OD, 2.030" Hsg.) (+.020 OD, 2.040" Hsg.) (+.020 OD, 2.040" Hsg.) (+.030 OD, 2.050" Hsg.) (+.030 OD, 2.050" Hsg.) (+.040 OD, 2.060" Hsg.) (+.040 OD, 2.060" Hsg.) (.001 Under ID)	CH-8 CH-4A CH-8W	CHP-8 or CHP-8T (Coated) CHP-8R1 or CHP-8R1T (Coated) CHP-8R2 or CHP-8R2T (Coated) CHP-8R3 or CHP-8R3T (Coated) CHP-8R4 or CHP-8R4T (Coated)	
8 cyl	265ci 4343cc	4.3L	3.750" 95.3mm	1955-57	OHV Chevrolet Eng.	CH-4	CHP-4 or CHP-4T (Coated)	
8 cyl	265ci	4.3L	3.750" 95.3mm	1980-81	OHV Pontiac Eng. Vin S (+.010 OD)	P-4 P-4R1	PP-4 or PP-4T (Coated)	

* Denotes (OHC) Repair Bearing, Check "Aluminum Overhead Cam Accessories" Section For Tool Information

** Denotes Auxiliary / Balance Shaft Bearing.

"und" Denotes Undersized ID

CAMSHAFT BEARINGS

DISPLACEMENT				YEAR	GENERAL APPLICATION DATA (ENGINE SERIES/MAKE/MODEL)	CAMSHAFT BEARING SET		
CYL.	CI./CC.	L	BORE			STD.	HI-PERF.	OHC
GENERAL MOTORS (BUICK, CADILLAC, CHEVROLET, GEO, GMC, OLDSMOBILE, PONTIAC, SATURN) (Cont.)								
8 cyl	267ci	4.4L	3.500" 88.9mm	1979-82	OHV Chevrolet Eng. Vin J (+.010 Oversize, 2.030 Hsg, .0795 Wall) (+.010 OD, 2.030" Hsg.) (+.010 OD, 2.030" Hsg.) (+.020 OD, 2.040" Hsg.) (+.020 OD, 2.040" Hsg.) (+.030 OD, 2.050" Hsg.) (+.030 OD, 2.050" Hsg.) (+.040 OD, 2.060" Hsg.) (+.040 OD, 2.060" Hsg.) (.001 Under ID)	CH-8 CH-4A CH-8W	CHP-8 or CHP-8T (Coated) CHP-8R1 or CHP-8R1T (Coated) CHP-8R2 or CHP-8R2T (Coated) CHP-8R3 or CHP-8R3T (Coated) CHP-8R4 or CHP-8R4T (Coated)	
6 cyl	270ci 4425cc	4.4L	3.781" 96mm	1939-62	OHV GMC Eng.	CH-2		
8 cyl	273ci 4474cc	4.5L	3.622" 92mm	1988-92	OHV Cadillac Eng. Vin 3, 5, 8 (Special Bearing Set w/ Wide No. 5 Position)	C-4 C-4A		
8 cyl	283ci 4638cc	4.6L	3.875" 98.4mm	1957-63	OHV Chevrolet Eng.	CH-4	CHP-4 or CHP-4T (Coated)	
8 cyl	283ci 4638cc	4.6L	3.875" 98.4mm	1964-67	OHV Chevrolet Eng. (+.010 Oversize, 2.030 Hsg, .0795 Wall) (+.010 OD, 2.030" Hsg.) (+.010 OD, 2.030" Hsg.) (+.020 OD, 2.040" Hsg.) (+.020 OD, 2.040" Hsg.) (+.030 OD, 2.050" Hsg.) (+.030 OD, 2.050" Hsg.) (+.040 OD, 2.060" Hsg.) (+.040 OD, 2.060" Hsg.) (.001 Under ID)	CH-8 CH-4A CH-8W	CHP-8 or CHP-8T (Coated) CHP-8R1 or CHP-8R1T (Coated) CHP-8R2 or CHP-8R2T (Coated) CHP-8R3 or CHP-8R3T (Coated) CHP-8R4 or CHP-8R4T (Coated)	
8 cyl	287ci 4707cc	4.7L	3.750" 95.3mm	1955	OHV Pontiac Eng.	P-3	PP-3 or PP-3T (Coated)	
8 cyl	288ci 4720cc	4.7L	3.750" 95.3mm	1955	OHV Pontiac Eng.	P-3	PP-3 or PP-3T (Coated)	
6 cyl	292ci 4801cc	4.8L	3.875" 98.4mm	1963-70	OHV Chevrolet Eng. Vin S	CH-7		
6 cyl	292ci 4801cc	4.8L	3.875" 98.4mm	1971-90	OHV Chevrolet Eng. Vin S, T (Special Oil Control Set w/ OD Groove)	CH-11 CH-11B		
8 cyl	294ci 4807cc	4.8L	3.780" 96mm	1999-05	OHV Chevrolet (Vortec) Eng. Vin V (1st Design; Positions 1 and 5 Housing Bore 2.3260"/2.3280")	CH-10	CHP-10 or CHP-10T (Coated)	
8 cyl	294ci 4807cc	4.8L	3.780" 96mm	2003-07	OHV Chevrolet (Vortec) Eng. Vin C, V (2nd Design; Positions 1 and 5 Housing Bore 2.3460"/2.3480")	CH-23	CHP-23 or CHP-23T (Coated)	

* Denotes (OHC) Repair Bearing, Check "Aluminum Overhead Cam Accessories" Section For Tool Information

** Denotes Auxiliary / Balance Shaft Bearing.

"und" Denotes Undersized ID

CAMSHAFT BEARINGS

DISPLACEMENT				YEAR	GENERAL APPLICATION DATA (ENGINE SERIES/MAKE/MODEL)	CAMSHAFT BEARING SET		
CYL.	CI/CC.	L	BORE			STD.	HI-PERF.	OHC
GENERAL MOTORS (BUICK, CADILLAC, CHEVROLET, GEO, GMC, OLDSMOBILE, PONTIAC, SATURN) (Cont.)								
8cyl	294ci 4807cc	4.8L	3.780" 96mm	2007-13	OHV Chevrolet (Vortec) Eng. L20 Series, Vin A, C, V (.775" Wide No.1-5 Position)	CH-25	CHP-25 or CHP-25T (Coated)	
8 cyl	300ci 4884cc	4.9L	3.622" 92mm	1991-95	OHV Cadillac Eng. Vin B (Special Bearing Set w/ Wide No. 5 Position)	C-4 C-4A		
8 cyl	300ci 4917cc	4.9L	3.750" 95.3mm	1964-67	OHV Buick Eng.	B-11		
8 cyl	301ci	4.9L	4.000" 101.6mm	1977-81	OHV Pontiac Eng. (Includes Turbo), Vin T, W, Y (+.010 OD)	P-4 P-4R1	PP-4 or PP-4T (Coated)	
6 cyl	302ci	5.0L	4.000" 101.6mm	1952-59	OHV (HD) GMC Eng.	CH-2		
8 cyl	302ci 4949cc	5.0L	4.000" 101.6mm	1967-69	OHV Chevrolet Eng. (+.010 Oversize, 2.030 Hsg, .0795 Wall) (+.010 OD, 2.030" Hsg.) (+.010 OD, 2.030" Hsg.) (+.020 OD, 2.040" Hsg.) (+.020 OD, 2.040" Hsg.) (+.030 OD, 2.050" Hsg.) (+.030 OD, 2.050" Hsg.) (+.040 OD, 2.060" Hsg.) (+.040 OD, 2.060" Hsg.) (.001 Under ID)	CH-8 CH-4A CH-8W	CHP-8 or CHP-8T (Coated) CHP-8R1 or CHP-8R1T (Coated) CHP-8R2 or CHP-8R2T (Coated) CHP-8R3 or CHP-8R3T (Coated) CHP-8R4 or CHP-8R4T (Coated)	
6 cyl	305ci 5012cc	5.0L	4.250" 108mm	1960-74	OHV GMC Eng. 305, 305C, 305E Series	GM-5		
8 cyl	305ci	5.0L	3.736" 95mm	1976-02	OHV Chevrolet (Vortec) Eng. Vin 7, E, F, G, H, M, Q, S, U (+.010 Oversize, 2.030 Hsg, .0795 Wall) (+.010 OD, 2.030" Hsg.) (+.010 OD, 2.030" Hsg.) (+.020 OD, 2.040" Hsg.) (+.020 OD, 2.040" Hsg.) (+.030 OD, 2.050" Hsg.) (+.030 OD, 2.050" Hsg.) (+.040 OD, 2.060" Hsg.) (+.040 OD, 2.060" Hsg.) (.001 Under ID)	CH-8 CH-4A CH-8W	CHP-8 or CHP-8T (Coated) CHP-8R1 or CHP-8R1T (Coated) CHP-8R2 or CHP-8R2T (Coated) CHP-8R3 or CHP-8R3T (Coated) CHP-8R4 CHP-8R4T (Coated)	
8 cyl	307ci	5.0L	3.800" 96.5mm	1980-90	OHV Oldsmobile Eng. Vin 9, Y	O-7		

* Denotes (OHC) Repair Bearing, Check "Aluminum Overhead Cam Accessories" Section For Tool Information

** Denotes Auxiliary / Balance Shaft Bearing.

"und" Denotes Undersized ID

CAMSHAFT BEARINGS

DISPLACEMENT				YEAR	GENERAL APPLICATION DATA (ENGINE SERIES/MAKE/MODEL)	CAMSHAFT BEARING SET		
CYL.	CI./CC.	L	BORE			STD.	HI-PERF.	OHC
GENERAL MOTORS (BUICK, CADILLAC, CHEVROLET, GEO, GMC, OLDSMOBILE, PONTIAC, SATURN) (Cont.)								
8 cyl	307ci 5031cc	5.0L	3.875" 98.4mm	1968-73	OHV Chevrolet Eng. Vin A, B, CA, DC, E, F, H, ME, ND, P, U, X (+.010 Oversize, 2.030 Hsg, .0795 Wall) (+.010 OD, 2.030" Hsg.) (+.010 OD, 2.030" Hsg.) (+.020 OD, 2.040" Hsg.) (+.020 OD, 2.040" Hsg.) (+.030 OD, 2.050" Hsg.) (+.030 OD, 2.050" Hsg.) (+.040 OD, 2.060" Hsg.) (+.040 OD, 2.060" Hsg.) (.001 Under ID)	CH-8 CH-4A CH-8W	CHP-8 or CHP-8T (Coated) CHP-8R1 or CHP-8R1T (Coated) CHP-8R2 or CHP-8R2T (Coated) CHP-8R3 or CHP-8R3T (Coated) CHP-8R4 or CHP-8R4T (Coated)	
8 cyl	317ci	5.2L	3.937" 100mm	1956	OHV Pontiac Eng.	P-3	PP-3 or PP-3T (Coated)	
8 cyl	324ci 5310cc	5.3L	3.875" 98.4mm	1954-56	OHV Oldsmobile Eng.	O-5		
8 cyl	325ci 5328cc	5.3L	3.780" 96mm	1999-05	OHV Chevrolet (Vortec) Eng. Vin P, T, Z (1st Design; Positions 1 And 5 Housing Bore 2.3260"/2.3280")	CH-10	CHP-10 or CHP-10T (Coated)	
8 cyl	325ci 5328cc	5.3L	3.780" 96mm	2003-09	OHV Chevrolet (Vortec) Eng. L59, LC9, LH8, LMF, LMG, LY5 Series, Vin 0, 3, 4, B, C, J, L, M, P, T, Z (2nd Design; Positions 1 And 5 Housing Bore 2.3460"/2.3480")	CH-23	CHP-23 or CHP-23T (Coated)	
8cyl	325ci 5328cc	5.3L	3.780" 96mm	2007-13	OHV Chevrolet (Vortec) Eng. L59, LC9, LH8, LMF, LMG, LY5 Series, Vin 0, 3, 4, 7, B, C, J, L, M, P, T, Z (.775" Wide No.1-5 Position)	CH-25	CHP-25 or CHP-25T (Coated)	
8 cyl	326ci 5343cc	5.3L	3.719" 94.5mm	1963-67	OHV Pontiac Eng. (+.010 OD)	P-4 P-4R1	PP-4 or PP-4T (Coated)	
8 cyl	327ci 5358cc	5.3L	4.000" 101.6mm	1962-63	OHV Chevrolet Eng.	CH-4	CHP-4 or CHP-4T (Coated)	
8 cyl	327ci 5358cc	5.3L	4.000" 101.6mm	1964-69	OHV Chevrolet Eng. Vin E, FB, HJ (+.010 Oversize, 2.030 Hsg, .0795 Wall) (+.010 OD, 2.030" Hsg.) (+.010 OD, 2.030" Hsg.) (+.020 OD, 2.040" Hsg.) (+.020 OD, 2.040" Hsg.) (+.030 OD, 2.050" Hsg.) (+.030 OD, 2.050" Hsg.) (+.040 OD, 2.060" Hsg.) (+.040 OD, 2.060" Hsg.) (.001 Under ID)	CH-8 CH-4A CH-8W	CHP-8 or CHP-8T (Coated) CHP-8R1 or CHP-8R1T (Coated) CHP-8R2 or CHP-8R2T (Coated) CHP-8R3 or CHP-8R3T (Coated) CHP-8R4 or CHP-8R4T (Coated)	
8 cyl	330ci 5409cc	5.4L	3.938" 100mm	1964-67	OHV Oldsmobile Eng. (Special Oil Control Set w/ OD Groove)	O-6 O-6B		
8 cyl	331ci 5425cc	5.4L	3.813" 96.8mm	1949-55	OHV Cadillac Eng.	C-2		

* Denotes (OHC) Repair Bearing, Check "Aluminum Overhead Cam Accessories" Section For Tool Information

** Denotes Auxiliary / Balance Shaft Bearing.

"und" Denotes Undersized ID

CAMSHAFT BEARINGS

DISPLACEMENT				YEAR	GENERAL APPLICATION DATA (ENGINE SERIES/MAKE/MODEL)	CAMSHAFT BEARING SET		
CYL.	CI/CC.	L	BORE			STD.	HI-PERF.	OHC
GENERAL MOTORS (BUICK, CADILLAC, CHEVROLET, GEO, GMC, OLDSMOBILE, PONTIAC, SATURN) (Cont.)								
8 cyl	336ci 5522cc	5.5L	3.875" 98.4mm	1958-59	OHV GMC Eng. Vin P	P-3	PP-3 or PP-3T (Coated)	
8 cyl	340ci 5573cc	5.6L	3.750" 95.3mm	1966	OHV Buick Eng.	B-8		
8 cyl	340ci 5573cc	5.6L	3.750" 95.3mm	1967	OHV Buick Eng.	B-11		
8 cyl	346ci 5665cc	5.7L	3.898" 99mm	1998-04	OHV Chevrolet (LS-1, LS-6) Eng. Vin G, S (1st Design; Positions 1 and 5 Housing Bore 2.3260"/2.3280")	CH-10	CHP-10 or CHP-10T (Coated)	
8 cyl	346ci 5665cc	5.7L	3.898" 99mm	2004-05	OHV Chevrolet (LS-1, LS-6) Eng. Vin S (2nd Design; Positions 1 and 5 Housing Bore 2.3460"/2.3480")	CH-23	CHP-23 or CHP-23T (Coated)	
8 cyl	347ci 5687cc	5.7L	3.938" 100mm	1957	OHV GMC Eng.	P-3	PP-3 or PP-3T (Coated)	
8 cyl	348ci 5704cc	5.7L	4.125" 104.8mm	1958-65	OHV Chevrolet Eng.	CH-5		
8 cyl	350ci 5736cc	5.7L	3.800" 96.5mm	1968-80	OHV Buick Eng. Vin B, H, J, K, X	B-9	BP-9 or BP-9T (Coated)	
8 cyl	350ci 5733cc	5.7L	3.875" 98.4mm	1968-77	OHV Pontiac Eng. Vin A, B, E, H, J, K, M, N, P, S (+.010 OD)	P-4 P-4R1	PP-4 or PP-4T (Coated)	
8 cyl	350ci 5736cc	5.7L	4.000" 101.6mm	1967-03	OHV Chevrolet (Vortec) Eng. Vin 4, 5, 6, 7, 8, A, B, E, G, H, J, K, L, M, N, P, R, T, V, W, X, Y (+.010 Oversize, 2.030 Hsg, .0795 Wall) (+.010 OD, 2.030" Hsg.) (+.010 OD, 2.030" Hsg.) (+.020 OD, 2.040" Hsg.) (+.020 OD, 2.040" Hsg.) (+.030 OD, 2.050" Hsg.) (+.030 OD, 2.050" Hsg.) (+.040 OD, 2.060" Hsg.) (+.040 OD, 2.060" Hsg.) (.001 Under ID)	CH-8 CH-4A CH-8W	CHP-8 or CHP-8T (Coated) CHP-8R1 or CHP-8R1T (Coated) CHP-8R2 or CHP-8R2T (Coated) CHP-8R3 or CHP-8R3T (Coated) CHP-8R4 or CHP-8R4T (Coated)	
8 cyl	350ci	5.7L	4.000" 101.6mm	1967-03	Chevrolet (Bowtie Bock) Eng. (2.000" Hsg Bores)		GMP-8 or GMP-8T (Coated)	
8 cyl	350ci	5.7L	4.000" 101.6mm	ALL	Chevrolet (Hi-Perf Block) Eng. (55mm/2.282" Camshaft Journal O.D.)		GMP-55 or GMP-55T (Coated)	
8 cyl	350ci 5733cc	5.7L	4.057" 103mm	1968-76	OHV Oldsmobile Eng. Vin H, K, M, R (Special Oil Control Set w/ OD Groove)	O-6 O-6B		
8 cyl	350ci	5.7L	4.057" 103mm	1977-85	OHV Oldsmobile Eng. (Includes Diesel) Vin 8, B, N, R, Z	O-7		
8 cyl	350ci	5.7L	4.057" 103mm	ALL	OHV Oldsmobile (Rocket Hi-Perf) Eng. (2.120" Hsg Bore, 1.95" Cam Journal)		GMP-1 or GMP-1T (Coated)	
6 cyl	351ci 5753cc	5.7L	4.563" 115.9mm	1960-73	OHV GMC Eng. 351, 351C, 351E, 351M, D351 Series (Includes Diesel)	GM-5		

* Denotes (OHC) Repair Bearing, Check "Aluminum Overhead Cam Accessories" Section For Tool Information

** Denotes Auxiliary / Balance Shaft Bearing.

"und" Denotes Undersized ID

CAMSHAFT BEARINGS

DISPLACEMENT				YEAR	GENERAL APPLICATION DATA (ENGINE SERIES/MAKE/MODEL)	CAMSHAFT BEARING SET		
CYL.	CI./CC.	L	BORE			STD.	HI-PERF.	OHC
GENERAL MOTORS (BUICK, CADILLAC, CHEVROLET, GEO, GMC, OLDSMOBILE, PONTIAC, SATURN) (Cont.)								
8 cyl	364ci 5697cc	6.0L	4.000" 101.6mm	1999-06	OHV Chevrolet (Vortec) Eng. Vin H, N, U (1st Design; Positions 1 and 5 Housing Bore 2.3260"/2.3280")	CH-10	CHP-10 or CHP-10T (Coated)	
8 cyl	364ci 5967cc	6.0L	4.000" 101.6mm	2003-09	OHV Chevrolet (Vortec) Eng. L76, LFA Series, Vin 5, H, K, N, U, Y (2nd Design; Positions 1 and 5 Housing Bore 2.3460"/2.3480")	CH-23	CHP-23 or CHP-23T (Coated)	
8 cyl	364ci 5967cc	6.0L	4.000" 101.6mm	2007-13	OHV Chevrolet (Vortec) Eng. L76, L77, L96, LC8, LFA, LZ1 Series, Vin 2, 5, 8, B, G, H, J, K, N, U, Y (.775" Wide No.1-5 Position)	CH-25	CHP-25 or CHP-25T (Coated)	
8 cyl	364ci 5967cc	6.0L	4.125" 104.8mm	1957-61	OHV Buick Eng.	B-8		
8 cyl	365ci 5972cc	6.0L	4.000" 101.6mm	1956-58	OHV Cadillac Eng.	C-2		
8 cyl	366ci 5999cc	6.0L	3.938" 100mm	1966	OHV Chevrolet Eng. (Bearing Set Requires Cam to Be Grooved)	CH-9A		
8 cyl	366ci 5999cc	6.0L	3.938" 100mm	1967-98	OHV Chevrolet Eng. L86, LS0 Series, Vin B, P (Special Oil Control Set w/ OD Groove) (+.010 OD, 2.150" Hsg.) (+.020 OD, 2.160" Hsg.)	CH-12 CH-12B	CHP-12 or CHP-12T (Coated) CHP-12R1 CHP-12R2	
8 cyl	368ci	6.0L	3.800" 96.5mm	1980-84	OHV Cadillac Eng. Vin 6, 9	C-3		
8 cyl	370ci 6064cc	6.1L	4.063" 103.2mm	1958	OHV Pontiac Eng.	P-3	PP-3 or PP-3T (Coated)	
8 cyl	371ci 6081cc	6.1L	4.000" 101.6mm	1957-60	OHV Oldsmobile Eng.	O-5		
8 cyl	376ci	6.2L	4.06" 103.3mm	2008-13	OHV Chevrolet (Vortec) Eng. Vin 2, F, J, P, R, T, W (.775" Wide No.1-5 Position)	CH-25	CHP-25 or CHP-25T (Coated)	
8 cyl	378ci 6199cc	6.2L	4.063" 103.2mm	2007-08	OHV Chevrolet (Vortec) Eng. L92 Series, Vin 8	CH-23	CHP-23 or CHP-23T (Coated)	
8 cyl	378ci 6199cc	6.2L	4.063" 103.2mm	2007-08	OHV Chevrolet (Vortec) Eng. L92 Series, Vin 8 (.775" Wide No.1-5 Position)	CH-25	CHP-25 or CHP-25T (Coated)	
6 cyl	379ci	6.2L	4.563" 115.9mm	1973-74	OHV GMC Eng.	GM-5		
8 cyl	379ci 6211cc	6.2L	3.976" 101mm	1982-93	OHV Chevrolet Diesel Eng. Vin C, J (+.020 OD)	GM-7 GM-7R2		
8 cyl	389ci 6376cc	6.4L	4.063" 103.2mm	1959-62	OHV Pontiac Eng.	P-3	PP-3 or PP-3T (Coated)	
8 cyl	389ci 6376cc	6.4L	4.063" 103.2mm	1963-66	OHV Pontiac Eng. (+.010 OD)	P-4 P-4R1	PP-4 or PP-4T (Coated)	
8 cyl	390ci 6392cc	6.4L	4.000" 101.6mm	1959-62	OHV Cadillac Eng.	C-2		
8 cyl	390ci 6392cc	6.4L	4.000" 101.6mm	1963	OHV Cadillac Eng.	C-3		
8 cyl	394ci 6458cc	6.5L	4.125" 104.8mm	1959-64	OHV Oldsmobile Eng.	O-5		

* Denotes (OHC) Repair Bearing, Check "Aluminum Overhead Cam Accessories" Section For Tool Information

** Denotes Auxiliary / Balance Shaft Bearing.

"und" Denotes Undersized ID

CAMSHAFT BEARINGS

DISPLACEMENT				YEAR	GENERAL APPLICATION DATA (ENGINE SERIES/MAKE/MODEL)	CAMSHAFT BEARING SET		
CYL.	CI/CC.	L	BORE			STD.	HI-PERF.	OHC
GENERAL MOTORS (BUICK, CADILLAC, CHEVROLET, GEO, GMC, OLDSMOBILE, PONTIAC, SATURN) (Cont.)								
8 cyl	395ci 6468cc	6.5L	4.055" 103mm	1992-02	OHV GMC Diesel/Turbo Diesel Eng. L65 Series, Vin F, P, S, Y (+.020 OD)	GM-7 GM-7R2		
8 cyl	396ci 6489cc	6.5L	4.094" 104mm	1965-66	OHV Chevrolet Eng.	CH-9A		
8 cyl	396ci 6489cc	6.5L	4.094" 104mm	1967-71	OHV Chevrolet Eng. Vin E, Y (Special Oil Control Set w/ OD Groove) (+.010 OD, 2.150" Hsg.) (+.020 OD, 2.160" Hsg.)	CH-12 CH-12B	CHP-12 or CHP-12T (Coated) CHP-12R1 CHP-12R2	
8 cyl	400ci 6555cc	6.6L	3.870" 98.4mm	1968-69	OHV Oldsmobile Eng. (Special Oil Control Set w/ OD Groove)	O-6 O-6B		
8 cyl	400ci	6.6L	3.870" 98.4mm	ALL	OHV Oldsmobile (Rocket Hi-Perf.) Eng. (2.186" Housing Bore)		GMP-1 or GMP-1T (Coated)	
8 cyl	400ci 6555cc	6.6L	4.000" 101.6mm	1965-67	OHV Oldsmobile Eng. (Special Oil Control Set w/ OD Groove)	O-6 O-6B		
8 cyl	400ci	6.6L	4.000" 101.6mm	ALL	OHV Oldsmobile (Rocket Hi-Perf.) Eng. (2.186" Housing Bore)		GMP-1 or GMP-1T (Coated)	
8 cyl	400ci 6555cc	6.6L	4.040" 102.6mm	1967-69	OHV Buick Eng.	B-9	BP-9 or BP-9T (Coated)	
8 cyl	400ci 6555cc	6.6L	4.120" 104.6mm	1967-79	OHV Pontiac Eng. Vin N, P, R, S, T, U, X, Y, Z (+.010 OD)	P-4 P-4R1	PP-4 or PP-4T (Coated)	
8 cyl	400ci 6555cc	6.6L	4.125" 104.8mm	1970-80	OHV Chevrolet Eng. Vin E, K, M, R, U, X (+.010 Oversize, 2.030 Hsg, .0795 Wall) (+.010 OD, 2.030" Hsg.) (+.010 OD, 2.030" Hsg.) (+.020 OD, 2.040" Hsg.) (+.020 OD, 2.040" Hsg.) (+.030 OD, 2.050" Hsg.) (+.030 OD, 2.050" Hsg.) (+.040 OD, 2.060" Hsg.) (+.040 OD, 2.060" Hsg.) (.001 Under ID)	CH-8 CH-4A CH-8W	CHP-8 or CHP-8T (Coated) CHP-8R1 or CHP-8R1T (Coated) CHP-8R2 or CHP-8R2T (Coated) CHP-8R3 or CHP-8R3T (Coated) CHP-8R4 or CHP-8R4T (Coated)	
6 cyl	401ci	6.6L	4.875" 123.8mm	1960-72	OHV GMC Eng. Vin M	GM-5		
8 cyl	401ci 6572cc	6.6L	4.188" 106.4mm	1959-66	OHV Buick Eng.	B-8		
8 cyl	402ci 6588cc	6.6L	4.125" 104.8mm	1970-72	OHV Chevrolet Eng. Vin E, K, S, U (Special Oil Control Set w/ OD Groove) (+.010 OD, 2.150" Hsg.) (+.020 OD, 2.160" Hsg.)	CH-12 CH-12B	CHP-12 or CHP-12T (Coated) CHP-12R1 CHP-12R2	
8 cyl	403ci 6599cc	6.6L	4.055" 103mm	2001-09	OHV GMC (Duramax) Turbo-Diesel Eng. LB7, LLY, LMM Series. Vin 1, 2, 3, 6, 9, D	GM-8		

* Denotes (OHC) Repair Bearing, Check "Aluminum Overhead Cam Accessories" Section For Tool Information

** Denotes Auxiliary / Balance Shaft Bearing.

"und" Denotes Undersized ID

CAMSHAFT BEARINGS

DISPLACEMENT				YEAR	GENERAL APPLICATION DATA (ENGINE SERIES/MAKE/MODEL)	CAMSHAFT BEARING SET		
CYL.	CI./CC.	L	BORE			STD.	HI-PERF.	OHC
GENERAL MOTORS (BUICK, CADILLAC, CHEVROLET, GEO, GMC, OLDSMOBILE, PONTIAC, SATURN) (Cont.)								
8 cyl	403ci	6.6L	4.351" 110.5mm	1977-79	OHV Oldsmobile Eng. Vin K	O-7		
8 cyl	409ci 6704cc	6.7L	4.313" 109.6mm	1961-65	OHV Chevrolet Eng.	CH-5		
8 cyl	421ci 6900cc	6.9L	4.094" 104mm	1961-62	OHV Pontiac Eng.	P-3	PP-3 or PP-3T (Coated)	
8 cyl	421ci 6900cc	6.9L	4.094" 104mm	1963-66	OHV Pontiac Eng. (+.010 OD)	P-4 P-4R1	PP-4 or PP-4T (Coated)	
8 cyl	425ci	7.0L	4.082" 103.7mm	1977-79	OHV Cadillac Eng. Vin S, T	C-3		
8 cyl	425ci 6966cc	7.0L	4.125" 104.8mm	1965-67	OHV Oldsmobile Eng. (Special Oil Control Set w/ OD Groove)	O-6 O-6B		
8 cyl	425ci 6966cc	7.0L	4.313" 109.6mm	1963-66	OHV Buick Eng.	B-8		
8 cyl	427ci 6998cc	7.0L	4.250" 108mm	1966	OHV Chevrolet Eng.	CH-9A		
8 cyl	427ci 6998cc	7.0L	4.250" 108mm	1967-98	OHV Chevrolet Eng. LR0, L43 Series, Vin E, M (Special Oil Control Set w/ OD Groove) (+.010 OD, 2.150" Hsg.) (+.020 OD, 2.160" Hsg.)	CH-12 CH-12B	CHP-12 or CHP-12T (Coated) CHP-12R1 CHP-12R2	
8 cyl	427ci 7011cc	7.0L	4.125" 104.8mm	2006-10	OHV Chevrolet Eng. LS-7 Series, Vin E	CH-23	CHP-23 or CHP-23T (Coated)	
8 cyl	427ci 7011cc	7.0L	4.125" 104.8mm	2006-13	OHV Chevrolet Eng. LS-7 Series, Vin E (.775" Wide No.1-5 Position)	CH-25	CHP-25 or CHP-25T (Coated)	
8 cyl	428ci 7014cc	7.0L	4.120" 104.6mm	1967-69	OHV Pontiac Eng. (+.010 OD)	P-4 P-4R1	PP-4 or PP-4T (Coated)	
8 cyl	429ci 7031cc	7.0L	4.129" 104.9mm	1964-67	OHV Cadillac Eng. Vin 5, 6, 7	C-3		
8 cyl	430ci 7047cc	7.0L	4.188" 106.4mm	1967-69	OHV Buick Eng.	B-9	BP-9 or BP-9T (Coated)	
6 cyl	432ci	7.1L	4.875" 123.8mm	1973-74	OHV (HD) GMC Eng.	GM-5		
8 cyl	454ci 7439cc	7.4L	4.250" 108mm	1970-00	OHV Chevrolet (Vortec) Eng. Vin B, D, E, J, L, N, S, V, W, X, Y, Z (Special Oil Control Set w/ OD Groove) (+.010 OD, 2.150" Hsg.) (+.020 OD, 2.160" Hsg.)	CH-12 CH-12B	CHP-12 or CHP-12T (Coated) CHP-12R1 CHP-12R2	
8 cyl	455ci 7456cc	7.5L	4.125" 104.8mm	1968-76	OHV Oldsmobile Eng. Vin R, S, T, U, V, W, X (Special Oil Control Set w/ OD Groove)	O-6 O-6B		
8 cyl	455ci 7456cc	7.5L	4.151" 105.4mm	1970-76	OHV Pontiac Eng. Vin T, U, V, W, X, Y (+.010 OD)	P-4 P-4R1	PP-4 or PP-4T (Coated)	

* Denotes (OHC) Repair Bearing, Check "Aluminum Overhead Cam Accessories" Section For Tool Information

** Denotes Auxiliary / Balance Shaft Bearing.

"und" Denotes Undersized ID

CAMSHAFT BEARINGS

DISPLACEMENT				YEAR	GENERAL APPLICATION DATA (ENGINE SERIES/MAKE/MODEL)	CAMSHAFT BEARING SET		
CYL.	CI/CC.	L	BORE			STD.	HI-PERF.	OHC
GENERAL MOTORS (BUICK, CADILLAC, CHEVROLET, GEO, GMC, OLDSMOBILE, PONTIAC, SATURN) (Cont.)								
8 cyl	455ci 7456cc	7.5L	4.313" 109.6mm	1970-76	OHV Buick Eng. Vin P, R, T, U, V, W	B-9	BP-9 or BP-9T (Coated)	
8 cyl	472ci 7735cc	7.7L	4.300" 109.2mm	1968-74	OHV Cadillac Eng. Vin 0, 1, 8, 9, R	C-3		
6 cyl	478ci	7.8L	5.125" 130.2mm	1962-75	OHV GMC Eng. 478M, D478, DH478 Series (Includes Diesel)	GM-5		
8 cyl	496ci	8.1L	4.252" 108mm	2001-09	OHV Chevrolet (Vortec) Eng. L18 Series, Vin E, G (Special Oil Control Set w/ OD Groove) (+.010 OD, 2.150" Hsg.) (+.020 OD, 2.160" Hsg.)	CH-12 CH-12B	CHP-12 or CHP-12T (Coated) CHP-12R1 CHP-12R2	
8 cyl	500ci 8193cc	8.2L	4.300" 109.2mm	1970-76	OHV Cadillac Eng. Vin 0, 1, S	C-3		
8 cyl	502ci	8.2L	4.466" 113.4mm	ALL	OHV Chevrolet (Bowtie Block) Eng. (Std. Hsg Bore) (Special Oil Control Set w/ OD Groove) (+.010 OD, 2.150" Hsg.) (+.020 OD, 2.160" Hsg.)	CH-12 CH-12B	CHP-12 or CHP-12T (Coated) CHP-12R1 CHP-12R2	
8 cyl	502ci	8.2L	4.466" 113.4mm	ALL	OHV Chevrolet (Bowtie Block) Eng. (2.120" Hsg Bore)	GM-12	GMP-12 or GMP-12T (Coated)	
8 cyl	636ci	10.4L	4.500" 114.3mm	1975-79	GMC Diesel Eng. (HD Truck/Industrial)	CAT-2		
8 cyl	855ci	14.0L	5.500" 139.7mm	1970-87	GMC Diesel/Turbo Diesel Eng. 230, 250, 270, 270E, 290, 300, 350, 400 Series (HD Truck/Industrial)	CU-5A		
8 cyl	855ci	14.0L	5.500" 139.7mm	1977-87	(2.500" Big Cam Series, 3/32 (.0939") Wall)	CU-9		
HERCULES								
3 cyl	130ci 2127cc	2.1L	3.500" 88.9mm	ALL	DD130, GO130 Series	HE-7		
3 cyl	149ci 2435cc	2.4L	3.750" 95.3mm	ALL	DD149, D1500, G1500, GO149, GO1500 Series	HE-7		
4 cyl	163ci	2.7L	4.000" 101.6mm	ALL	G-1600, J4XL-D3 Series	HE-1		
4 cyl	164ci	2.7L	3.500" 88.9mm	ALL	JX4E2 Series	HE-1		
3 cyl	169ci	2.8L	4.000" 101.6mm	ALL	D1700, DD169, G1700, GO169 Series	HE-7		
4 cyl	173ci	2.8L	3.500" 88.9mm	ALL	DD173, GO173 Series	HE-8		
4 cyl	188ci	3.1L	3.750" 95.3mm	ALL	JX4C2, JX4C3, JX4C5, JX4E3 Series	HE-1		
6 cyl	191ci	3.1L	3.125" 79.4mm	ALL	QXA, QXA3, QXA5 Series	HE-5		
4 cyl	198ci	3.3L	3.750" 95.3mm	ALL	D2000, DD198, DOOB Series	HE-1		
4 cyl	199ci	3.3L	3.750" 95.3mm	ALL	DD198, D2000, D2120, G2000, G2120, GO198 Series	HE-8		
6 cyl	205ci	3.4L	3.250" 82.6mm	ALL	QXB, QXB3, QXB5 Series	HE-5		
4 cyl	214ci	3.5L	4.000" 101.6mm	ALL	JX4D, JX4D2, JX4D3, JX4D5, JX4E5 Series	HE-1		

* Denotes (OHC) Repair Bearing, Check "Aluminum Overhead Cam Accessories" Section For Tool Information

** Denotes Auxiliary / Balance Shaft Bearing.

"und" Denotes Undersized ID

CAMSHAFT BEARINGS

DISPLACEMENT				YEAR	GENERAL APPLICATION DATA (ENGINE SERIES/MAKE/MODEL)	CAMSHAFT BEARING SET		
CYL.	CI./CC.	L	BORE			STD.	HI-PERF.	OHC
HERCULES (Cont.)								
6 cyl	222ci	3.6L	3.375" 85.7mm	ALL	QXC, QXC3, QXC5 Series	HE-5		
4 cyl	226ci	3.7L	4.000" 101.6mm	ALL	D2300, DD226, G2300, GO226 Series	HE-1		
6 cyl	228ci	3.7L	3.375" 85.7mm	ALL	JXA Series	HE-1		
6 cyl	230ci	3.8L	3.438" 87.3mm	ALL	QXD, QXD3, QXD5 Series	HE-5		
6 cyl	232ci	3.8L	3.406" 86.5mm	ALL	JX, JXF Series	HE-1		
6 cyl	237ci	3.9L	3.438" 87.3mm	ALL	QXLD, QXLD3, QXLD5 Series	HE-5		
6 cyl	245ci	4.0L	3.500" 88.9mm	ALL	JXE, JXG Series	HE-1		
6 cyl	260ci	4.3L	3.500" 88.9mm	ALL	DD260, G0260 Series	HE-8		
6 cyl	263ci	4.3L	3.625" 92.1mm	ALL	JXB Series	HE-1		
6 cyl	282ci	4.6L	3.750" 95.3mm	ALL	JXC, JXC3, JXCF Series	HE-1		
6 cyl	298ci	4.9L	3.750" 95.3mm	ALL	298, D298H, DD298, G298H, GO298 Series	HE-8		
6 cyl	298ci	4.9L	3.750" 95.3mm	ALL	3000, D300, D300T, D3000, G3000 Series	HE-8A		
6 cyl	320ci	5.2L	4.000" 101.6mm	ALL	JXD, JXDT Series	HE-1		
6 cyl	339ci	5.6L	4.000" 101.6mm	ALL	JXLD Series	HE-1		
6 cyl	339ci	5.6L	4.000" 101.6mm	ALL	339, 339H, D339, D339H, DD339, DD339H, G0339 Series	HE-8		
6 cyl	339ci	5.6L	4.000" 101.6mm	ALL	D3400, G3400 Series	HE-8A		
HOLDEN								
6 cyl	132.67ci 2174cc	2.174L	3.000" 76.2mm	1948-59	Holden Eng. 132 Grey Series	HO-3		
6 cyl	138ci 2261.42cc	2.261L	3.063" 77.8mm	1960-63	Holden Eng. 138 Grey Series	HO-3		
6 cyl	138.06ci	-	3.125" 79.4mm	1971-73	Holden Eng. 138 Red (2250) Series	HO-1		
6 cyl	149.32ci	-	3.250" 82.6mm	1963-66	Holden Eng. 149 Red Series	HO-1		
6 cyl	161.03ci	-	3.375" 85.7mm	1966-71	Holden Eng. 161 Red (2650) Series	HO-1		
6 cyl	173.18ci	-	3.500" 88.9mm	1971-80	Holden Eng. 173 Blue/Black (2850), 173 Red (2850) Series	HO-1		
6 cyl	179.42ci	-	3.563" 90.5mm	1963-66	Holden Eng. 179 Red Series	HO-1		
6 cyl	185.77ci	-	3.625" 92.1mm	1966-71	Holden Eng. 186 Red Series	HO-1		
6 cyl	201.25ci	-	3.625" 92.1mm	1971-86	Holden Eng. 202 Blue/Black (3300), 202 Red (3300) Series	HO-1		

* Denotes (OHC) Repair Bearing, Check "Aluminum Overhead Cam Accessories" Section For Tool Information

** Denotes Auxiliary / Balance Shaft Bearing.

"und" Denotes Undersized ID

CAMSHAFT BEARINGS

CYL.	DISPLACEMENT			YEAR	GENERAL APPLICATION DATA (ENGINE SERIES/MAKE/MODEL)	CAMSHAFT BEARING SET		
	CI/CC.	L	BORE			STD.	HI-PERF.	OHC
HOLDEN (Cont.)								
8 cyl	252.86ci	-	3.625" 92.1mm	1980-85	Holden Eng. 253 Blue (4.2) Series (+.002 OD, No. 5 Position)	HO-2 HO-2S	HOP-2S or HOP-2ST (Coated)	
8 cyl	307.88ci	-	4.000" 101.6mm	1969-80	Holden Eng. 308 Red Series (+.002 OD, No. 5 Position)	HO-2 HO-2S	HOP-2S or HOP-2ST (Coated)	
HONDA								
4 cyl	82ci 1342cc	1.3L	2.913" 74mm	1984-87	SOHC (16 Valve) Honda Eng. D13A1, D13A2, EV1, EV2 Series			HA-2* (1/2 Shell)
4 cyl	91ci 1488cc	1.5L	2.913" 74mm	1984-87	SOHC Honda Eng. D15A2, EW1 Series			HA-2* (1/2 Shell)
4 cyl	91ci 1493cc	1.5L	2.953" 75mm	1988-91	SOHC (16 Valve) Honda Eng. D15B1, D15B2, D15B7, D15Z1 Series (1.100" Camshaft Journal Diameter)			HA-3* (1/2 Shell)
4 cyl	97ci 1590cc	1.6L	2.953" 75mm	1992-95	SOHC (16 Valve) Honda (VTEC) Eng. D16Z6 Series			HA-4* (1/2 Shell)
4 cyl	- 1829cc	1.8L	3.150" 80.7mm	1983-87	SOHC Honda Eng. A18A1, A18A2, ES1, ES2, ES3, ET1, ET2 Series			HA-1* (1/2 Shell)
4 cyl	- 1955cc	2.0L	3.258" 82.7mm	1985-89	SOHC Honda Eng. A20A1, A20A2, A20A3, A20A4, BS1, BS2, BT1, BT2 Series			HA-1* (1/2 Shell)
4 cyl	131.6ci 2156cc	2.2L	3.346" 85mm	1990-97	SOHC Honda Eng. F22A1, F22A4, F22A6, F22B1, F22B2, F22B6 Series (1.100" Camshaft Journal Diameter)			HA-3* (1/2 Shell)
HYUNDAI								
4 cyl	89.6ci 1468cc	1.5L	2.972" 75.5mm	1986-94	SOHC (8 Valve) Mitsubishi Eng. 4G15, G4AJ, G4DJ Series, Vin J, K			MIA-3* (Full Round)
4 cyl	- 1596cc	1.6L	3.028" 76.9mm	1985-90	SOHC (8 Valve) Mitsubishi Eng. 4G32, G32B Series, Vin K (Cam Bearing Set w/ Heavy Wall, +.020 OD)			MIA-1* (1/2 Shell) MIA-2* (1/2 Shell)
4 cyl	122ci 1997cc	2.0L	3.346" 85mm	1981-98	SOHC (8 Valve)/DOHC (16 Valve) Mitsubishi Eng. 4G63, G4CP, G63B Series (Includes Turbo), Vin F (Balance Shaft Set)	MIG-3**		
4 cyl	143.4ci 2351cc	2.4L	3.406" 86.5mm	1989-91	SOHC (8 Valve) Mitsubishi Eng. G4CS Series, Vin S (Cam Bearing Set w/ Heavy Wall, +.020 OD) (Balance Shaft Set)	MIG-3**		MIA-1* (1/2 Shell) MIA-2* (1/2 Shell)
IHC (NAVISTAR) TRUCK								
4 cyl	73.1ci 1198cc	1.2L	2.578" 65.5mm	ALL	IHC Eng. A55, AM80 Series	DA-2		
4 cyl	91ci 1489cc	1.5L	2.874" 73mm	1957-63	IHC Eng. A55, AM80 Series	DA-2		
4 cyl	132ci	2.2L	3.250" 82.6mm	ALL	OHV IHC Eng. FC, FC132, FK132 Series	WA-3		
4 cyl	152ci 2491cc	2.5L	3.875" 98.4mm	1961-71	OHV IHC Eng. 4-152, 4-152T, B-152 Series	IN-11		
6 cyl	175ci	2.9L	3.000" 76.2mm	ALL	IHC/Navistar (L-Head) Eng. GRD175, GRD175A, HD174 Series	J-1		
6 cyl	193ci	3.2L	3.250" 82.6mm	ALL	IHC/Navistar (L-Head) Eng.	J-1		
4 cyl	196ci 3203cc	3.2L	4.125" 104.8mm	1966-80	OHV IHC/Navistar Eng. 4-196, 4-196E Series	IN-11		

* Denotes (OHC) Repair Bearing, Check "Aluminum Overhead Cam Accessories" Section For Tool Information

** Denotes Auxiliary / Balance Shaft Bearing.

"und" Denotes Undersized ID

CAMSHAFT BEARINGS

DISPLACEMENT				YEAR	GENERAL APPLICATION DATA (ENGINE SERIES/MAKE/MODEL)	CAMSHAFT BEARING SET		
CYL.	CI./CC.	L	BORE			STD.	HI-PERF.	OHC
IHC (NAVISTAR) TRUCK (Cont.)								
6 cyl	198ci 3246cc	3.2L	3.268" 83mm	1976-80	OHV Nissan Diesel/Turbo Diesel Eng. 6-33, 6-33T, IN633, SD33 Series	DA-5		
6 cyl	214ci	3.5L	3.313" 84.2mm	1937-49	IHC (L-Head) Eng. HD3, HD4 Series	J-1		
6 cyl	220ci 3608cc	3.6L	3.563" 90.5mm	1950-68	OHV IHC Eng. BD220, BG220, SD220, U220 Series	IN-14		
6 cyl	232ci 3802cc	3.8L	3.750" 95.3mm	1969-72	OHV AMC Eng. 6-232 Series (Special Oil Control Set w/ OD Groove No. 2, 3 Position) (Special Oil Control Set w/ OD Groove No. 2, 3 Position), (.001 Under ID)	N-7 N-7B N-7BW		
6 cyl	233ci	3.8L	3.313" 84.2mm	ALL	IHC (L-Head) Eng. GRD233, GRD233A, HD232, HD232A Series	J-1		
6 cyl	240ci 3933cc	3.9L	3.563" 90.5mm	1956-70	OHV IHC Eng. BD240, BG241, SD240 Series	IN-14		
6 cyl	241ci	3.9L	3.375" 85.7mm	1937-40	IHC Eng. BG241 Series	IN-14		
6 cyl	242ci	4.0L	3.375" 85.7mm	ALL	OHV IHC Eng.	J-1		
6 cyl	258ci 4228cc	4.2L	3.750" 95.3mm	1972-74	OHV AMC Eng. 6-258 Series, Vin A (Special Oil Control Set w/ OD Groove No. 2, 3 Position) (Special Oil Control Set w/ OD Groove No. 2, 3 Position), (.001 Under ID)	N-7 N-7B N-7BW		
6 cyl	259ci	4.3L	3.500" 88.9mm	ALL	OHV IHC Eng. FAB259 Series	J-1		
6 cyl	264ci 4335cc	4.3L	3.688" 93.7mm	1957-70	OHV IHC Eng. BD264, BG264, BG265, SD264 Series	IN-14		
8 cyl	266ci 4360cc	4.3L	3.625" 92.1mm	1959-72	OHV IHC Eng. V266 Series	IN-11		
6 cyl	301ci	4.9L	3.813" 96.9mm	1963-70	IHC Diesel/Turbo-Diesel Eng. D301, DT301 Series	IN-14		
8 cyl	304ci 4982cc	5.0L	3.875" 98.4mm	1961-80	OHV IHC Eng. V304, V304E Series	IN-11		
6 cyl	318ci	5.2L	3.875" 98.4mm	1944-47	IHC Eng. RED318, RED318A Series	IN-3		
8 cyl	345ci 5654cc	5.6L	3.875" 98.4mm	1961-82	OHV IHC Eng. V345, V345A, V345E Series	IN-11		
6 cyl	360ci	5.9L	3.875" 98.4mm	1987-94	IHC Diesel/Turbo-Diesel Eng. DT360, DTA360 Series	IN-19		
6 cyl	361ci	5.9L	4.125" 104.8mm	1938-49	IHC Diesel/Turbo-Dieses Eng. D361, DT361, FBB361, FBC361, RED361, RED361A Series	IN-3		
8 cyl	365ci	6.0L	3.740" 94.99mm	2002-12	International Turbo-Diesel Eng. VT365 Series, Vin AF	IN-21		
6 cyl	372ci	6.1L	4.375" 111.1mm	1954-69	IHC Eng. RD372, RED372 Series	IN-3		
8 cyl	392ci 6424cc	6.4L	4.125" 104.8mm	1966-85	OHV IHC Eng. V392, V392E, UV392 Series.	IN-11		
8 cyl	400ci 6571cc	6.6L	4.165" 105.8mm	1974	OHV AMC Eng. V400 Series (+.010 OD)	N-9 N-9R1		
6 cyl	401ci	6.6L	4.125" 104.8mm	1949-74	OHV IHC Eng. 1FBC401, RED401, RED401A, RED401B Series	IN-3		
8 cyl	401ci	6.6L	4.125" 104.8mm	1960-74	OHV IHC Eng. V401, VS401, UV401 Series	IN-10A		

* Denotes (OHC) Repair Bearing, Check "Aluminum Overhead Cam Accessories" Section For Tool Information

** Denotes Auxiliary / Balance Shaft Bearing.

"und" Denotes Undersized ID

CAMSHAFT BEARINGS

DISPLACEMENT				YEAR	GENERAL APPLICATION DATA (ENGINE SERIES/MAKE/MODEL)	CAMSHAFT BEARING SET		
CYL.	CI/GC.	L	BORE			STD.	HI-PERF.	OHC
IHC (NAVISTAR) TRUCK (Cont.)								
8 cyl	404ci	6.6L	4.125" 104.8mm	1975-82	OHV IHC Eng. MV404 Series (+.020 OD, -.005 Journal)	IN-17 IN-17R2		
6 cyl	406ci	6.7L	4.375" 111.1mm	1954-74	IHC Eng. R406, RD406, RED406, U406 Series	IN-3		
6 cyl	414ci	6.8L	4.300" 109.2mm	ALL	IHC Diesel Eng. D414, DT414 Series	IN-19		
8 cyl	420ci	6.9L	4.000" 101.6mm	1982-88	Navistar Diesel/Turbo-Diesel Eng. D421 Series (+.020 OD, -.005 Journal)	IN-17 IN-17R2		
6 cyl	436ci	7.1L	4.300" 109.2mm	ALL	IHC Diesel/Turbo-Diesel Eng. D436, DT436, DT436B Series	IN-19		
8 cyl	444ci	7.3L	4.110" 104.4mm	1988-05	OHV IHC (IDI) Diesel/Turbo-Diesel Eng. T444E Series (+.020 OD, -.005 Journal)	IN-17 IN-17R2		
8 cyl	446ci	7.3L	4.125" 104.8mm	1975-81	IHC Eng. MV446 Series (+.020 OD, -.005 Journal)	IN-17 IN-17R2		
6 cyl	450ci	7.4L	4.375" 111.1mm	1954-74	IHC Eng. RD450, RED450, RED450A, RED450B, RED450C, RED450D, RED450U Series	IN-3		
8 cyl	461ci	7.6L	4.125" 104.8mm	1960-73	IHC Gas/Diesel Eng. DV462, DV462B, UV461, V461, VS461 Series	IN-10A		
6 cyl	464ci	7.6L	4.437" 112.7mm	1968-71	OHV Cummins Diesel/Turbo-Diesel Eng. C160-C180 Series	CU-5A		
6 cyl	466ci	7.6L	4.300" 109.2mm	1975-12	IHC Diesel/Turbo-Diesel Eng. D466, DT466, DT466B, DT466C, DTA466C, DTI466B, DTI466C Series	IN-19		
8 cyl	478ci	7.8L	4.500" 114.3mm	1965-77	IHC Eng. V478, VS478 Series	IN-10A		
6 cyl	501ci	8.2L	4.500" 114.3mm	1960-74	IHC Eng. R501, RD501, RED501, U501 Series	IN-3		
8 cyl	522ci	8.6L	4.500" 114.3mm	1974	OHV Caterpillar Diesel Eng. 1140, 1145, 3145 Series	CAT-2		
8 cyl	537ci	8.8L	4.625" 117.5mm	1977-81	IHC Eng. V537, VS537 Series	IN-10A		
8 cyl	549ci	9.0L	4.500" 114.3mm	1961-79	IHC Diesel Eng. FTV549, FTVS549, V549, VS549, VT549, UV549 Series	IN-10A		
8 cyl	551ci	9.0L	4.510" 114.6mm	1980-88	IHC Diesel/Turbo-Diesel Eng. DV550, DV-B550, D551 Series	IN-10A		
8 cyl	573ci	9.4L	4.500" 114.3mm	1974	OHV Caterpillar Diesel Eng. 1150, 3150 Series	CAT-2		
8 cyl	605ci	9.9L	4.625" 117.5mm	ALL	IHC Eng. C605, V605 Series	IN-10A		
8 cyl	636ci	10.4L	4.500" 114.3mm	1973-81	OHV Caterpillar Diesel/Turbo-Diesel Eng. 1160, 3160, 3208, 3208T Series	CAT-2		
6 cyl	743ci	12.2L	5.125" 130.2mm	1968-71	OHV Cummins Diesel Eng. NH-NHE180, NHE195, NH220 Series (Small Cam Series)	CU-5A		
6 cyl	743ci	12.2L	5.125" 130.2mm	ALL	OHV Cummins Diesel Eng. HRF6B Series (2.500" Big Cam Series, 3/32 Wall)	CU-9		
6 cyl	855ci	14.0L	5.500" 139.7mm	1968-83	OHV Cummins Diesel Eng. NH-NHC230, NH-NHC250, NHCT-CT, NHCT270, NTA370, NTC270-NTC400, PT270 Series (Small Cam Series)	CU-5A		
6 cyl	855ci	14.0L	5.500" 139.7mm	1977-83	OHV Cummins Diesel Eng. NH-NHC230, NH-NHC250, NHCT-CT, NHCT270, NTA370, NTC270-NTC400, PT270 (2.500" Big Cam Series, 3/32 Wall)	CU-9		

* Denotes (OHC) Repair Bearing, Check "Aluminum Overhead Cam Accessories" Section For Tool Information

** Denotes Auxiliary / Balance Shaft Bearing.

"und" Denotes Undersized ID

CAMSHAFT BEARINGS

DISPLACEMENT				YEAR	GENERAL APPLICATION DATA (ENGINE SERIES/MAKE/MODEL)	CAMSHAFT BEARING SET		
CYL.	CI./CC.	L	BORE			STD.	HI-PERF.	OHC
IHC (NAVISTAR) TRUCK (Cont.)								
6 cyl	927ci	15.2L	5.500" 139.7mm	1973-74	OHV Cummins Diesel Eng. N927, Super 250, Super 270, Super 300, Super 330 Series	CU-5A		
IHC TRACTOR & INDUSTRIAL								
4 cyl	69ci	1.1L	2.500" 63.5mm	ALL	Continental (L-Head) Eng. LY69, PY69, Y4069, Y69 Series	CO-3		
4 cyl	112ci	1.8L	3.187" 80.95mm	ALL	Continental (L-Head) Eng. Y112 Series	CO-3		
4 cyl	132ci	2.2L	3.250" 82.6mm	ALL	OHV IHC Eng. CK, FC, FC132, FG132, FK132, FL Series	WA-3		
4 cyl	144ci	2.4L	3.375" 85.7mm	ALL	IHC Gas/Diesel Eng. BC144, BD144, BD144C Series	IN-18		
4 cyl	152ci	2.5L	3.375" 85.7mm	ALL	IHC Eng. C152, U-4 Series	IN-15		
4 cyl	153ci	2.5L	3.375" 85.7mm	ALL	IHC Eng. UC153 Series (Early)	IN-15		
4 cyl	154ci	2.5L	3.500" 88.9mm	ALL	IHC Gas/Diesel Eng. BD154, BD154T Series	IN-18		
4 cyl	164ci	2.7L	3.500" 88.9mm	ALL	IHC Eng. C164, U164 Series	IN-15		
4 cyl	166ci	2.7L	3.688" 93.7mm	ALL	IHC Diesel Eng. D166 Series	IN-12		
4 cyl	169ci	2.8L	3.563" 90.5mm	ALL	IHC Eng. C169, U169 Series	IN-15		
6 cyl	174ci	2.8L	3.000" 76.2mm	ALL	IHC Eng. HD174 Series	IN-15		
4 cyl	175ci	2.8L	3.625" 92.1mm	ALL	IHC Eng. C175, U175 Series (Early)	IN-15		
4 cyl	175ci	2.9L	3.563" 90.5mm	ALL	IHC Eng. C175 Series (Late)	IN-15		
4 cyl	188ci	3.1L	3.688" 93.7mm	ALL	IHC Diesel Eng. D188 Series	IN-12		
4 cyl	193ci	3.2L	3.750" 95.3mm	ALL	Continental Diesel Eng. D193 Series	CO-9		
6 cyl	193ci	3.2L	3.250" 82.6mm	ALL	IHC Eng. 193 Series	J-1		
6 cyl	213ci	3.5L	3.313" 84.2mm	ALL	IHC Eng. HD213 Series	J-1		
6 cyl	214ci	3.5L	3.313" 84.2mm	ALL	IHC Eng. 214 Series	J-1		
6 cyl	220ci	3.6L	3.563" 90.5mm	ALL	IHC Eng. BD220, C220, UC220 Series	IN-14		
6 cyl	221ci	3.6L	3.563" 90.5mm	ALL	IHC Eng. C221, UC221 Series	IN-14		
6 cyl	232ci	3.8L	3.313" 84.2mm	ALL	IHC Eng. HD232 Series	J-1		
6 cyl	232ci	3.8L	3.750" 95.3mm	ALL	OHV AMC (Hi-Torque) Eng. C232 Series (Special Oil Control Set w/ OD Groove No. 2, 3 Position) (Special Oil Control Set w/ OD Groove No. 2, 3 Position), (.001 Under ID)	N-7 N-7B N-7BW		
6 cyl	233ci	3.8L	3.375" 95.3mm	ALL	IHC Eng. GRD233 Series	J-1		

* Denotes (OHC) Repair Bearing, Check "Aluminum Overhead Cam Accessories" Section For Tool Information

** Denotes Auxiliary / Balance Shaft Bearing.

"und" Denotes Undersized ID

CAMSHAFT BEARINGS

DISPLACEMENT				YEAR	GENERAL APPLICATION DATA (ENGINE SERIES/MAKE/MODEL)	CAMSHAFT BEARING SET		
CYL.	CI/CC.	L	BORE			STD.	HI-PERF.	OHC
IHC TRACTOR & INDUSTRIAL (Cont.)								
6 cyl	236ci	3.9L	3.688" 93.7mm	ALL	IHC Diesel Eng. C236, D236, UD236 Series	IN-14		
4 cyl	248ci	4.1L	3.875" 98.4mm	ALL	IHC Eng. C248, U6 Series	IN-5		
6 cyl	263ci	4.3L	3.563" 90.5mm	ALL	IHC Eng. C263, U263, UC263 Series	IN-14		
4 cyl	264ci	4.3L	4.000" 101.6mm	ALL	IHC Gas Eng. C264, D264, U264, UD264, UD264A Series	IN-5		
6 cyl	264ci	4.3L	3.688" 93.7mm	ALL	OHV IHC Eng. BD264 Series	IN-14		
4 cyl	281ci	4.6L	4.125" 104.8mm	ALL	IHC Gas Eng. C281, D281, U281 Series	IN-5		
6 cyl	282ci	4.6L	3.688" 93.7mm	ALL	IHC Gas/Diesel Eng. C282, D282, D282H, DT282, UDT282 Series	IN-14		
6 cyl	291ci	4.8L	3.750" 95.3mm	ALL	IHC Eng. C291 Series	IN-14		
6 cyl	301ci	4.9L	3.813" 96.9mm	ALL	IHC Gas/Diesel Eng. C301, D301, DT301, UC301 Series	IN-14		
8 cyl	304ci	5.0L	3.875" 98.4mm	ALL	OHV IHC Eng. V304 Series	IN-11		
6 cyl	312ci	5.1L	3.875" 98.4mm	ALL	IHC Diesel Eng. D312, DT312, UD312 Series	IN-19		
8 cyl	345ci	5.6L	3.875" 98.4mm	ALL	OHV IHC Eng. V345 Series	IN-11		
6 cyl	360ci	5.9L	3.875" 98.4mm	ALL	IHC Diesel Eng. D360, DT360, UD360 Series	IN-19		
6 cyl	361ci	5.9L	4.125" 104.8mm	ALL	IHC Diesel/Turbo-Diesel Eng. D361, DT361, UD361 Series	IN-16		
6 cyl	372ci	6.1L	4.375" 111.1mm	ALL	IHC Eng. R372, RD372, RED372, U372, UR372 Series	IN-3		
8 cyl	392ci	6.4L	4.125" 104.8mm	ALL	OHV IHC Eng. V392 Series	IN-11		
6 cyl	406ci	6.7L	4.375" 111.1mm	ALL	IHC Eng. R406, RD406, RED406, U406 Series	IN-3		
6 cyl	407ci	6.7L	4.321" 109.7mm	ALL	IHC Diesel/Turbo-Diesel Eng. D407, DT407 Series	IN-16		
6 cyl	414ci	6.8L	4.300" 109.2mm	ALL	IHC Diesel Eng. D414, DT414, UD414 Series	IN-19		
6 cyl	436ci	7.1L	4.300" 109.2mm	ALL	IHC Diesel/Turbo-Diesel Eng. D436, DT436, DT436B Series	IN-19		
6 cyl	450ci	7.4L	4.375" 111.1mm	ALL	IHC Eng. R450, U450, UR450 Series	IN-3		
6 cyl	466ci	7.6L	4.300" 109.2mm	ALL	IHC Diesel/Turbo-Diesel Eng. D466, DT466, DT466B, DTA466C, DT1466B, DT1466C, UD466 Series	IN-19		
6 cyl	501ci	8.2L	4.500" 114.3mm	ALL	IHC Eng. U501, UR501 Series	IN-3		
8 cyl	551ci	9.0L	4.510" 114.6mm	ALL	IHC Diesel Eng. DV550, DV551 Series	IN-10A		
8 cyl	605ci	9.9L	4.625" 117.5mm	ALL	IHC Eng. C605 Series	IN-10A		
8 cyl	743ci	12.2L	5.125" 130.2mm	ALL	OHV Cummins Diesel Eng. NRT, NTO Series (Small Cam Series)	CU-5A		

* Denotes (OHC) Repair Bearing, Check "Aluminum Overhead Cam Accessories" Section For Tool Information

** Denotes Auxiliary / Balance Shaft Bearing.

"und" Denotes Undersized ID

CAMSHAFT BEARINGS

DISPLACEMENT				YEAR	GENERAL APPLICATION DATA (ENGINE SERIES/MAKE/MODEL)	CAMSHAFT BEARING SET		
CYL.	CI./CC.	L	BORE			STD.	HI-PERF.	OHC
IHC TRACTOR & INDUSTRIAL (Cont.)								
8 cyl	743ci	12.2L	5.125" 130.2mm	1977-On	OHV Cummins Diesel Eng. HRB Series (2.500" Big Cam Series, 3/32 Wall)	CU-9		
8 cyl	855ci	14.0L	5.500" 139.7mm	ALL	OHV Cummins Diesel Eng. NT, NTA, NTC, NTE, NTF, NTO Series (2.500" Big Cam Series, 3/32 Wall)	CU-5A		
8 cyl	855ci	14.0L	5.500" 139.7mm	1977-On	OHV Cummins Diesel Eng. NT, NTA, NTC, NTE, NTF, NTO Series	CU-9		
ISUZU (Also see GENERAL MOTORS)								
4 cyl	80.8ci 1325cc	1.3L	2.953" 75mm	1966-72	SOHC Isuzu Eng. G130 Series (Auxiliary Shaft Set)	CHG-14**		
4 cyl	89.7ci 1471cc	1.5L	3.031" 77mm	1969-70	SOHC Isuzu Eng. 4XC1, 4XC1T Series (Includes Turbo) (Auxiliary Shaft Set)	CHG-14**		
4 cyl	96.6ci 1584cc	1.6L	3.228" 82mm	1966-79	OHV Isuzu Eng. G161 Series (Auxiliary Shaft Set)	CHG-14**		
4 cyl	- 1817cc	1.8L	3.307" 84mm	1981-85	SOHC Isuzu Gas/Diesel Eng. G180, G180S, G180SS, G180Z Series, Vin B, N, P (Cam Bearing Set w/ Heavy Wall, +.020 OD) (Auxiliary Shaft Set)	CHG-14**		MIA-1* (1/2 Shell) MIA-2* (1/2 Shell)
4 cyl	- 1949cc	1.9L	3.425" 87mm	1983-87	SOHC Isuzu Eng. G200, G200W, G200Z Series, Vin A (Cam Bearing Set w/ Heavy Wall, +.020 OD) (Auxiliary Shaft Set)	CHG-14**		MIA-1* (1/2 Shell) MIA-2* (1/2 Shell)
4 cyl	119ci 1951cc	2.0L	3.385" 86mm	1968-79	OHV Isuzu Eng. G201 Series	IZ-2		
4 cyl	119ci 1951cc	2.0L	3.385" 86mm	1972-88	OHV Isuzu Diesel Eng. C190 Series	IZ-3		
4 cyl	134ci 2180cc	2.2L	3.504" 89mm	1996-00	OHV Chevrolet Eng. LN2 Series, Vin 4 (.002 Under ID)	CH-19 CH-19X2		
4 cyl	- 2207cc	2.2L	3.268" 83mm	1964-79	OHV Isuzu Diesel Eng. C220, C221 Series	IZ-2		
4 cyl	- 2238cc	2.2L	3.465" 88mm	1981-82	OHV Isuzu Diesel Eng. C223 Series, Vin S	IZ-2		
4 cyl	- 2238cc	2.2L	3.465" 88mm	1983-87	OHV/SOHC Isuzu Diesel/Turbo-Diesel Eng. C223, C223T, LQ7, LW7 Series, Vin S, U	IZ-3		
4 cyl	- 2254cc	2.3L	3.516" 89.3mm	1986-95	SOHC Isuzu Eng. 4ZD1, LW3 Series, Vin L (Cam Bearing Set w/ Heavy Wall, +.020 OD)			MIA-1* (1/2 Shell) MIA-2* (1/2 Shell)
4 cyl	144.6ci 2369cc	2.4L	3.386" 86mm	1969-88	OHV Isuzu Diesel Eng. C240 Series	IZ-2		
4 cyl	- 2499cc	2.5L	3.661" 93mm	1985-90	OHV Isuzu Diesel Eng. 4JA1 Series	IZ-5		
4 cyl	- 2559cc	2.6L	3.646" 92.6mm	1988-97	SOHC Isuzu Eng. 4ZE1, RLJ Series, Vin E (Cam Bearing Set w/ Heavy Wall, +.020 OD)			MIA-1* (1/2 Shell) MIA-2* (1/2 Shell)
4 cyl	- 2772cc	2.8L	3.661" 93mm	1985-90	OHV Isuzu Diesel/Turbo-Diesel Eng. 4JB1, 4JB1T Series	IZ-5		
4 cyl	- 2775cc	2.8L	3.858" 98mm	1973-76	OHV Isuzu Diesel Eng. 4BA1 Series	IZ-6		
4 cyl	- 2775cc	2.8L	3.858" 98mm	1977-90	OHV Isuzu Diesel Eng. 4BA1 Series	IZ-7		

* Denotes (OHC) Repair Bearing, Check "Aluminum Overhead Cam Accessories" Section For Tool Information

** Denotes Auxiliary / Balance Shaft Bearing.

"und" Denotes Undersized ID

CAMSHAFT BEARINGS

CYL.	DISPLACEMENT			YEAR	GENERAL APPLICATION DATA (ENGINE SERIES/MAKE/MODEL)	CAMSHAFT BEARING SET		
	CI/CC.	L	BORE			STD.	HI-PERF.	OHC
ISUZU (Also see GENERAL MOTORS) (Cont.)								
6 cyl	- 2827cc	2.8L	3.500" 88.9mm	1989-91	OHV Chevrolet Eng. LL2 Series, Vin R (Special Bearing Set w/ Wide No. 2, 3 Position) (Oversize OD - See Set Contents) (Oversize OD)	CH-18 CH-18A CH-18RS CH-18R8		
6 cyl	- 3137cc	3.1L	3.504" 89mm	1991-94	OHV Chevrolet Eng. CPC, LG6 Series, Vin Z (Special Bearing Set w/ Wide No. 2, 3 Position) (Oversize OD - See Set Contents) (Oversize OD)	CH-18 CH-18A CH-18RS CH-18R8		
4 cyl	- 3268cc	3.3L	4.016" 102mm	1979-88	OHV Isuzu Diesel Eng. 4BC1, 4BC2 Series	IZ-7		
4 cyl	- 3595cc	3.6L	4.016" 102mm	1973-76	OHV Isuzu Diesel Eng. 4BB1 Series	IZ-6		
4 cyl	- 3595cc	3.6L	4.016" 102mm	1977-90	OHV Isuzu Diesel Eng. 4BB1 Series	IZ-7		
4 cyl	236ci 3856cc	3.9L	4.016" 102mm	1985-98	OHV Isuzu Diesel/Turbo-Diesel/Turbo-Intercooled Diesel Eng. 4BD1, 4BD1N, 4BD1T, 4BD2TC Series	IZ-7		
6 cyl	262ci 4294cc	4.3L	4.000" 101.6mm	1997-00	OHV Chevrolet (Vortec H.O.) Eng. LB4, LF6 Series, Vin X, W (Except Engines Stamped With Identification Numbers Located On Front Of Block Starting With T) (.001 Under ID) (Balance Shaft Rear Bearing, Includes Tool) (Cam Bearing & Balance Shaft Kit)	CH-17 CH-17X CHG-15A** CH-17G	CHP-17 or CHP-17T (Coated)	
6 cyl	262ci 4294cc	4.3L	4.000" 101.6mm	1997-00	OHV Chevrolet (Vortec H.O.) Eng. LB4, LF6 Series, Vin X, W (Engines Stamped With Identification Number On Front Of Block Starting With T) (.001 Under ID) (Balance Shaft Rear Bearing, Includes Tool) (Cam Bearing & Balance Shaft Kit)	CH-21 CH-21X CHG-15A** CH-21G	CHP-21 or CHP-21T (Coated)	
6 cyl	- 4978cc	5.0L	3.858" 98mm	1970-88	OHV Isuzu Diesel Eng. D500 Series	IZ-8		
6 cyl	- 5393cc	5.4L	4.016" 102mm	1972-90	OHV Isuzu Diesel Eng. 6BB1 Series	IZ-8		
8 cyl	350ci 5736cc	5.7L	4.000" 101.6mm	1992-02	OHV Chevrolet (Vortec) Eng. CPC Series, Vin A, R	CH-8	CHP-8 or CHP-8T (Coated)	
6 cyl	353ci 5785cc	5.8L	4.016" 102mm	1976-91	OHV Isuzu Diesel/Turbo-Diesel Eng. 6BD1, 6BD1T Series, Vin N	IZ-8		
6 cyl	- 6130cc	6.1L	4.016" 102mm	1979-90	OHV Isuzu Diesel Eng. 6BF1 Series	IZ-8		
6 cyl	396ci 6494cc	6.5L	4.134" 105mm	1984-94	OHV Isuzu Diesel/Turbo-Diesel Eng. 6BG1 Series	IZ-8		
JEEP (WILLYS) (Also see AMERICAN MOTORS & CHRYSLER)								
4 cyl	134ci 2197cc	2.2L	3.125" 79.4mm	1941-73	Jeep/Willys (F-Head, Hurricane)/(L-Head, Lightning) Eng. Vin 4, F, J, R, T	J-1		
4 cyl	141.5ci	2.3L	3.875" 98.4mm	ALL	Jeep/Willys (L-Head) Eng.	F-25		
4 cyl	144.6ci 2369cc	2.4L	3.386" 86mm	1981-86	OHV Isuzu Diesel Eng. C240 Series	IZ-2		
4 cyl	150ci	2.5L	3.313" 84.1mm	1966-67	Continental Eng.	CO-3		
4 cyl	150ci	2.5L	3.875" 98.4mm	1983-02	OHV AMC/Chrysler Eng. Vin E, H, P, U (Special Oil Control Set w/ OD Groove No. 2, 3 Position) (Special Oil Control Set w/ OD Groove No. 2, 3 Position), (.001 Under ID)	N-7 N-7B N-7BW		

* Denotes (OHC) Repair Bearing, Check "Aluminum Overhead Cam Accessories" Section For Tool Information

** Denotes Auxiliary / Balance Shaft Bearing.

"und" Denotes Undersized ID

CAMSHAFT BEARINGS

DISPLACEMENT				YEAR	GENERAL APPLICATION DATA (ENGINE SERIES/MAKE/MODEL)	CAMSHAFT BEARING SET		
CYL.	CI./CC.	L	BORE			STD.	HI-PERF.	OHC
JEEP (WILLYS) (Also see AMERICAN MOTORS & CHRYSLER) (Cont.)								
4 cyl	151ci	2.5L	4.000" 101.6mm	1980-83	OHV Pontiac Eng. Vin B (.001 Under ID)	CH-16 CH-16W		
6 cyl	173ci 2835cc	2.8L	3.504" 89mm	1984-86	OHV Chevrolet Eng. Vin W (Special Bearing Set w/ Wide No. 2, 3 Position) (Oversize OD - See Set Contents) (Oversize OD)	CH-18 CH-18A CH-18RS CH-18R8		
6 cyl	225ci 3687cc	3.7L	3.750" 95.3mm	1966-71	OHV Buick Eng.	B-6		
6 cyl	226ci 3704cc	3.7L	3.313" 84.1mm	1947-66	OHV Continental (F-Head)/(L-Head) Eng. Vin T	K-1		
6 cyl	232ci 3802cc	3.8L	3.750" 95.3mm	1964-78	OHV AMC (Hi-Torque) Eng. 1L, 3L, 7L, 8L, 9L Series, Vin E (Special Oil Control Set w/ OD Groove No. 2, 3 Position) (Special Oil Control Set w/ OD Groove No. 2, 3 Position), (.001 Under ID)	N-7 N-7B N-7BW		
6 cyl	242ci	4.0L	3.875" 98.4mm	1987-01	OHV AMC/Chrysler Eng. Vin L, M, S (Special Oil Control Set w/ OD Groove No. 2, 3 Position) (Special Oil Control Set w/ OD Groove No. 2, 3 Position), (.001 Under ID)	N-7 N-7B N-7BW		
6 cyl	242ci	4.0L	3.875" 98.4mm	2002-06	OHV Chrysler Eng. Vin S	N-10		
6 cyl	258ci 4228cc	4.2L	3.750" 95.3mm	1971-90	OHV AMC Eng. Vin A, C, M, T (Special Oil Control Set w/ OD Groove No. 2, 3 Position) (Special Oil Control Set w/ OD Groove No. 2, 3 Position), (.001 Under ID)	N-7 N-7B N-7BW		
8 cyl	304ci 4982cc	5.0L	3.750" 95.3mm	1971-81	OHV AMC Eng. Vin H (+.010 OD)	N-9 N-9R1		
8 cyl	318ci 5211cc	5.2L	3.910" 99.3mm	1993-98	OHV Chrysler Eng. Vin Y	PD-25	PDP-25 or PDP-25T (Coated)	
8 cyl	327ci 5358cc	5.3L	4.000" 101.6mm	1965-70	OHV AMC (Vigilante) Eng. Vin E	H-5		
8 cyl	350ci 5736cc	5.7L	3.800" 96.5mm	1968-71	OHV Buick Eng. Vin 9, K	B-9	BP-9 or BP-9T (Coated)	
8 cyl	360ci	5.9L	4.000" 101.6mm	1998	OHV Chrysler Eng. Vin Z	PD-25	PDP-25 or PDP-25T (Coated)	
8 cyl	360ci 5899cc	5.9L	4.080" 103.6mm	1970-91	OHV AMC Eng. Vin 7, N, P (+.010 OD)	N-9 N-9R1		
8 cyl	401ci 6571cc	6.6L	4.165" 105.8mm	1974-78	OHV AMC Eng. Vin Z (+.010 OD)	N-9 N-9R1		
JOHN DEERE								
2 cyl	100ci	1.6L	4.000" 101.6mm	ALL	John Deere Eng. 40, 320, 330, 435, M Series, Crawler-Tractor: 40-40U, M, MC, MCT, MI, MT Series	JD-5		
2 cyl	113ci	1.9L	4.250" 108mm	1956-60	John Deere Eng. 113 Series, Crawler-Tractor: 420, 430, 430c, 440 Series	JD-5		
4 cyl	115ci	1.9L	3.500" 88.9mm	1961-71	John Deere Eng. 1010, 115, JD115 Series, Combine-Tractor: EA, 115G, HA 115G, HB 115, 115G, GH, NA 115G	JD-1		
4 cyl	145ci	2.4L	3.625" 92.1mm	1961-71	John Deere Gas/Diesel Eng. 145, 2010 Series, Combine-Tractor: EA 145G, HA 145, 145G, HB145, 145G, HC 145G, L, TA 145G, L	JD-1		

* Denotes (OHC) Repair Bearing, Check "Aluminum Overhead Cam Accessories" Section For Tool Information

** Denotes Auxiliary / Balance Shaft Bearing.

"und" Denotes Undersized ID

CAMSHAFT BEARINGS

DISPLACEMENT				YEAR	GENERAL APPLICATION DATA (ENGINE SERIES/MAKE/MODEL)	CAMSHAFT BEARING SET		
CYL.	CI/CC.	L	BORE			STD.	HI-PERF.	OHC
JOHN DEERE (Cont.)								
4 cyl	155ci	2.5L	3.750" 95.3mm	ALL	John Deere Diesel Eng. 155, HA155D Series, Combine-Tractor, Power Unit: 45, 155	JD-1		
4 cyl	162ci	2.6L	3.438" 87.3mm	ALL	Continental Eng. F162 Series, Combine: No. 8	CO-8		
4 cyl	165ci	2.7L	3.875" 98.4mm	1961-71	John Deere Gas/Diesel Eng. 165, 2010 Series, Combine-Tractor: 40, 45, HA 165G, HB 165D, HB 165G	JD-1		
4 cyl	188ci	3.1L	3.750" 95.3mm	ALL	Hercules Eng. JX4C3 Series, Combine-Tractor: 45	HE-1		
4 cyl	198ci	3.3L	3.750" 95.3mm	ALL	OHV Hercules Eng. DD-198, DOOB, D2000 Series, Combine: No. 5, 10-12 Cut	HE-1		
4 cyl	201ci	3.3L	4.000" 101.6mm	ALL	John Deere Eng. 201, 3010 Series 201G Loader/Tractor: 500C, 510, JD500	JD-3		
4 cyl	202ci	3.3L	3.858" 98mm	1966-75	John Deere Gas/Diesel/LPG Eng. 202, 4-202D, 4-202G Series, 45, 3300, 4400 Series Combine; JD480A Series Forklift; 310, 401, 410 Series Loader; 499 Series Picker/ Stripper; 202 Series Power Unit; 400-2520 Series Tractor; 880, 2270, 2280 Series Windrower (Balance Shaft Set)	JDG-7**		
6 cyl	217ci	3.6L	3.625" 92.1mm	ALL	John Deere Eng. EA, HA217G & L, HB217L, HC217, G, L, HD217, G, L, HG217G, NA217G, NA217L, NB217G, NB217L, TA217G, L, N, 217 Gas Eng. & Power Unit. Combine: 55, 55R, 65, 67R, 90, 95, 95H, 95R Forage Harvester: 12 Series	JD-2		
4 cyl	219ci	3.6L	4.020" 102.1mm	1966-75	John Deere Diesel/Turbo-Diesel Eng. 4-219D, 4-219T Series, 3300, 4400 Series Combine; JD 310, 401, 410 Series Loader; 219 Series Power Unit; 440-2420 Series Tractor (Balance Shaft Set)	JDG-7**		
4 cyl	222ci	3.6L	3.375" 85.7mm	ALL	Hercules Eng. QXC Series, Combine: No. 5A, No. 9 Prairie, No.35 Hillside, 55, 55R, 65	HE-5		
4 cyl	225ci	3.7L	3.400" 86.4mm	1960-78	OHV Chrysler (Slant 6) Eng. (Early Series With Forged Crankshaft)	PD-18		
4 cyl	225ci	3.7L	3.400" 86.4mm	1979-87	OHV Chrysler (Slant 6) Eng. (Late Series With Cast Crankshaft)	PD-21		
4 cyl	226ci	3.7L	4.000" 101.6mm	ALL	Hercules Eng. DOOC, DD-G0226, D-G2300 Series, No. 5A, No.35 Hillside	HE-1		
4 cyl	227ci	3.7L	4.250" 108mm	ALL	John Deere Gas/LPG Eng. 3020, 4227G, 4227LP Series, Tractor: JD500, JD500B, JD510	JD-3		
6 cyl	230ci	3.8L	3.438" 87.3mm	ALL	Hercules Eng. QXD-3 Series Power Unit. Combine: No. 5A, No. 9 Prairie, No.35 Hillside, 55, 55R, 65	HE-5		
6 cyl	232ci	3.8L	3.875" 98.4mm	ALL	John Deere Diesel Eng. HA232D Series, Combine 95, 95H	JD-2		
4 cyl	239ci	3.9L	4.188" 106.4mm	1966-75	John Deere Diesel/Turbo-Diesel Eng. 4-239D, 4-239T, 4039, 4239D Series; 4239 Series Tractor (Balance Shaft Set)	JDG-7**		
4 cyl	241ci	3.9L	4.125" 104.8mm	ALL	John Deere Eng. 4241G Series; Loader: 500C, 510, 3010, 3020, JD500	JD-3		
6 cyl	248ci	4.1L	3.875" 98.4mm	ALL	John Deere Eng. BA248G, HA 248G, HB248G, L, NA 248G, 248 Series Power Unit/Diesel Eng. Combine: 95, 95H	JD-2		
4 cyl	254ci	4.2L	4.125" 104.8mm	ALL	John Deere Diesel Eng. 4254D Series; Loader: 500C, 510 Tractor: JD500A, 3010	JD-3		
4 cyl	270ci	4.4L	4.250" 108mm	ALL	John Deere Diesel Eng. 4270D Series; Loader: JD500, JD500A, B, C, JD510 Series. Tractor: 3020 Series	JD-3		
4 cyl	276ci	4.5L	4.188" 106.4mm	ALL	John Deere Diesel/Turbo-Diesel Eng. 4045D, T, 276D, 4276D, 4276T, JD550 Series Crawler; 440C, 540, 555 Series Loader; 4276D, T Series Power Unit; 2630, 2640, JD440C, JD540 Series Tractor (Balance Shaft Set)	JDG-7**		

* Denotes (OHC) Repair Bearing, Check "Aluminum Overhead Cam Accessories" Section For Tool Information

** Denotes Auxiliary / Balance Shaft Bearing.

"und" Denotes Undersized ID

CAMSHAFT BEARINGS

DISPLACEMENT				YEAR	GENERAL APPLICATION DATA (ENGINE SERIES/MAKE/MODEL)	CAMSHAFT BEARING SET		
CYL.	CI./CC.	L	BORE			STD.	HI-PERF.	OHC
JOHN DEERE (Cont.)								
6 cyl	282ci	4.6L	3.750" 95.3mm	ALL	Hercules Eng. JXC, JXCT Series; No. 17, 12-20 Cut, No.36- 36A-36B-36H-36P all 12-20 Cut	HE-1		
6 cyl	302ci	4.9L	4.000" 101.6mm	ALL	John Deere Eng. Series 4010; Combine: 105, Wheel Tractor: 4000, 4010, 4020, 4230	JD-4		
6 cyl	329ci	5.4L	4.020" 102.1mm	ALL	John Deere Diesel/Turbo-Diesel Eng. HF329G, NB329 Series, 329DH-GH-GN- LN, 6329D, 6329G, 6329T	JD-4		
6 cyl	340ci	5.6L	4.250" 108mm	ALL	John Deere Gas/LPG Eng. 340, 341, HA341G, HG341G Series; Combine: 105, 105R; Tractor: JD600, 4020	JD-4		
6 cyl	359ci	5.9L	4.188" 106.4mm	ALL	John Deere Gas/Diesel Eng. 6359D, 6359G, Series; Tractor: 2940 Series	JD-4		
6 cyl	360ci	5.9L	4.250" 108mm	ALL	John Deere Gas/Diesel Eng. M21HA, 362GH-01, 02; 362GHA, 720, 730 Series	JD-4		
6 cyl	381ci	6.2L	4.125" 104.8mm	ALL	John Deere Diesel Eng. 6381D Series; Power Unit: 4010; Tractor: JD600-690, 4010 Series	JD-4		
6 cyl	404ci	6.6L	4.250" 108mm	ALL	John Deere Diesel Eng. M23HA, 404D, 404DH-01, 02; 404DHA, 6404D, DH, TH Series; Combine: 105-7700 Series Loader/Tractor: 4000-4520 Series; JD600-JD690A Series	JD-4		
6 cyl	466ci	7.6L	4.563" 115.9mm	ALL	John Deere Diesel/Turbo-Diesel Eng. 466, 6466A, 6466D, 6466T, 6466TA, 6466TH Series; Combine: 6602- 8820; Tractor: 790-4850 Series	JD-4		
6 cyl	531ci	8.7L	4.750" 120.7mm	ALL	John Deere Diesel/Turbo-Diesel Eng. 531, 6531D Series; Harvester: 5010-5460; Tractor: JD644C-JD772A	JD-4		
6 cyl	619ci	10.1L	5.125" 130.2mm	ALL	John Deere Diesel/Turbo (Intercooled) Diesel Eng. 619, 6619A, 6619TA Series; Tractor: JD850-890; 5440-8650	JD-4		
KOMATSU								
6 cyl	743ci	12.2L	5.125" 130.2mm	ALL	Cummins/Komatsu Diesel Eng. NH220 Series (Small Cam Series); Komatsu Machine Models D60, D65, D75, D80A-12, D85A-12	CU-5A		
6 cyl	855ci	14.0L	5.500" 139.7mm	ALL	Cummins/Komatsu Diesel Eng. NT855 Series (Small Cam Series); Komatsu Machine Models D80A-18, D85A-18, D95S-2	CU-5A		
LE ROI								
4 cyl	176ci	2.9L	3.750" 95.3mm	ALL	Le Roi (Early D Model) Eng. D176 Series	A-2		
4 cyl	201ci	3.3L	4.000" 101.6mm	ALL	Le Roi (Early D Model) Eng. D201 Series	A-2		
4 cyl	226ci	3.7L	4.000" 101.6mm	ALL	Le Roi (Early D Model) Eng. D226 Series	A-2		
6 cyl	382ci	6.2L	4.500" 114.3mm	ALL	Le Roi Eng. 60 G1 Series	A-2		
MACK TRUCK								
4 cyl	98ci	1.6L	3.125" 79.4mm	ALL	Continental Eng.	CO-8		
4 cyl	113ci	1.9L	3.000" 76.2mm	ALL	Continental Eng.	CO-8		
4 cyl	123ci	2.0L	3.125" 79.4mm	ALL	Continental Eng.	CO-8		
4 cyl	133ci	2.2L	3.250" 82.6mm	ALL	Continental Eng.	CO-8		
4 cyl	140ci	2.3L	3.188" 80.98mm	ALL	Continental (L-Head) Eng.	CO-8		
4 cyl	145ci	2.4L	3.250" 82.6mm	ALL	Continental Eng.	CO-8		
6 cyl	209ci	3.4L	3.188" 80.98mm	1936-48	Continental Eng. EN-11 Series	K-1		

* Denotes (OHC) Repair Bearing, Check "Aluminum Overhead Cam Accessories" Section For Tool Information

** Denotes Auxiliary / Balance Shaft Bearing.

"und" Denotes Undersized ID

CAMSHAFT BEARINGS

DISPLACEMENT				YEAR	GENERAL APPLICATION DATA (ENGINE SERIES/MAKE/MODEL)	CAMSHAFT BEARING SET		
CYL.	CI/CC.	L	BORE			STD.	HI-PERF.	OHC
MAK TRUCK (Cont.)								
6 cyl	226ci	3.7L	3.313" 84.1mm	1939-42	Continental Eng. EN-12, EN226 Series	K-1		
6 cyl	253ci	4.1L	3.500" 88.9mm	1950-55	Continental Eng. EN-253, FO Series	CO-7		
6 cyl	271ci	4.4L	3.625" 92.1mm	ALL	Continental Eng. EN-271, FK, FM Series	CO-7		
6 cyl	290ci	4.8L	3.750" 95.3mm	ALL	Continental Eng. EN-290, FK, FM Series.	CO-7		
6 cyl	330ci	5.4L	4.000" 101.6mm	ALL	Continental Eng. EN-330, EN-331 Series	CO-7		
8 cyl	413ci	6.7L	4.188" 106.4mm	ALL	OHV Chrysler/Mack Eng. EN-414, EN414A Series (+.010 OD)	PD-17	PDP-17 or PDP-17T (Coated) PDP-17R1	
6 cyl	672ci	11.0L	4.875" 123.8mm	ALL	Cummins/Mack Eng. EN-END-ENDS672, END673, ENDT673 Series (Early Design, Slotted Bearings In Position 2 And 5) (Auxiliary Shaft Set)	MA-5 MAG-10**		
6 cyl	672ci	11.0L	4.875" 123.8mm	ALL	Cummins/Mack Eng. END673, END675, END676, ENDL-ENDLT, ENDT673 (Engs. After Serial# ENDT-673-62-63), END675, ENDT-ENDTB676, ENT675, ETAB673, ETAB675, ETAB676, ETAY-ETAZ673, ETB-ETC-ETS673, ETSZ676, ETSZB676, ETSZ677, ETSZB677, ETY-ETZ673, ETZB673 (Auxiliary Shaft Set)	MA-6 MAG-10**		
6 cyl	672ci	11.0L	4.875" 123.8mm	ALL	Cummins/Mack Eng. (Late Design After 4/84 With #7 Journal Of 2.440" Diameter) (Auxiliary Shaft Set)	MA-7 MAG-10**		
6 cyl	680ci	11.0L	4.875" 123.8mm	ALL	Mack Eng. E6, EM6 Series (Early Design, Slotted Bearings In Position 2 And 5) (Auxiliary Shaft Set)	MA-5 MAG-10**		
6 cyl	680ci	11.0L	4.875" 123.8mm	ALL	Mack Eng. (Early Design, Before 4/84 With #7 Journal of 2.250" Diameter, With 1.500" Groove Bearing on Position 2-6) (Auxiliary Shaft Set)	MA-6 MAG-10**		
6 cyl	680ci	11.0L	4.875" 123.8mm	ALL	Mack Eng. (Late Design After 4/84 With #7 Journal Of 2.440" Diameter) (Auxiliary Shaft Set)	MA-7 MAG-10**		
6 cyl	707ci	11.6L	5.000" 127mm	ALL	Mack Eng. END707, ENG-ENDD-ENDDL711, ENDL707, ENDL-ENDLT711, ENF707 Series (Early Design, Slotted Bearings In Position 2 And 5) (Auxiliary Shaft Set)	MA-5 MAG-10**		
6 cyl	707ci	11.6L	5.000" 127mm	ALL	Mack Eng. (Early Design, Before 4/84 With #7 Journal of 2.250" Diameter, With 1.500" Groove Bearing on Position 2-6) (Auxiliary Shaft Set)	MA-6 MAG-10**		
6 cyl	707ci	11.6L	5.000" 127mm	ALL	Mack Eng. (Late Design After 4/84 With #7 Journal Of 2.440" Diameter) (Auxiliary Shaft Set)	MA-7 MAG-10**		
6 cyl	728ci	11.9L	4.875" 123.8mm	ALL	Mack Eng. E7, EM7 Series (Auxiliary Shaft Set)	MA-11 MAG-11		
6 cyl	761ci	12.5L	4.875" 123.8mm	ALL	Mack Eng. E7, E7-350, E7-400 Series	MA-8		
MAZDA								
4 cyl	71.3ci 1169cc	1.2L	2.756" 70mm	1968-73	OHV Mazda Eng. TA, TB Series			F-41* (1/2 Shell)
4 cyl	- 1290cc	1.3L	3.071" 78mm	1990-92	DOHC Mazda Eng. BJ Series (1 Cam Set Per Cylinder Head)			MZA-1* (Full Round)
4 cyl	90.6ci 1490cc	1.5L	3.071" 78mm	1966-74	SOHC Mazda Eng. UB Series			F-41* (1/2 Shell)

* Denotes (OHC) Repair Bearing, Check "Aluminum Overhead Cam Accessories" Section For Tool Information

** Denotes Auxiliary / Balance Shaft Bearing.

"und" Denotes Undersized ID

CAMSHAFT BEARINGS

DISPLACEMENT				YEAR	GENERAL APPLICATION DATA (ENGINE SERIES/MAKE/MODEL)	CAMSHAFT BEARING SET		
CYL.	CI./CC.	L	BORE			STD.	HI-PERF.	OHC
MAZDA (Cont.)								
4 cyl	96.8ci 1586cc	1.6L	3.071" 78mm	1970-77	SOHC Mazda Eng. NA Series			F-41* (1/2 Shell)
4 cyl	- 1597cc	1.6L	3.071" 78mm	1986-95	SOHC Mazda Eng. B6, B6B Series			MZA-1* (Full Round)
4 cyl	- 1587cc	1.6L	3.189" 81mm	1982-88	SOHC Mazda Eng. F6 Series			MZA-2* (1/2 Shell)
4 cyl	110ci 1796cc	1.8L	3.071" 78mm	1970-78	SOHC Mazda Eng. VB Series			F-41* (1/2 Shell)
4 cyl	107.9ci 1769cc	1.8L	3.150" 80mm	1973-88	SOHC Mazda Eng. VC Series			F-41* (1/2 Shell)
4 cyl	- 1839cc	1.8L	3.268" 83mm	1990-94	SOHC Mazda Eng. BP, BP012 Series			MZA-1* (Full Round)
4 cyl	- 1789cc	1.8L	3.386" 86mm	1982-89	SOHC Mazda Eng. F8 Series			MZA-2* (1/2 Shell)
6 cyl	- 1845cc	1.8L	2.953" 75mm	1992-95	DOHC Mazda Eng. K8, K8ZE Series (1 Cam Set Per Cylinder Head)			MZA-1* (Full Round)
4 cyl	- 1970cc	2.0L	3.150" 80mm	1979-84	SOHC Mazda Eng. MA Series			F-41* (1/2 Shell)
4 cyl	122ci 1998cc	2.0L	3.386" 86mm	1984-87	SOHC Mazda Eng. FE, FEH1, FEH5, FE-T Series (Includes Turbo)			MZA-2* (1/2 Shell)
4 cyl	- 2184cc	2.2L	3.386" 86mm	1987-93	SOHC Mazda Eng. F2, F2G, F2L, F2-T Series (Includes Turbo)			MZA-2* (1/2 Shell)
4 cyl	140ci 2302cc	2.3L	3.780" 96mm	1994-97	SOHC Ford Eng. 8A Series, Vin A (Special Oil Control Set w/ OD Groove) (Cam Bearing Set w/ .020 Oversize OD) (Auxiliary Shaft Set)	F-34 F-34B F-34S FG-34**		
4 cyl	- 2555cc	2.6L	3.587" 91.1mm	1987-88	SOHC (8 Valve) Mitsubishi Eng. AM1, G54B Series (Cam Bearing Set w/ Heavy Wall, +.020 OD) (Balance Shaft Set) (Balance Shaft Bearing w/ .173 Oversize OD) (Balance Shaft Elim)	MIG-2** MIG-2-1R MIG-2E**		MIA-1* (1/2 Shell) MIA-2* (1/2 Shell)
4 cyl	- 2606cc	2.6L	3.622" 92mm	1989-94	SOHC (12 Valve) Mazda Eng. G6 Series (Balance Shaft Set)	MZG-3**		MZA-4* (1/2 Shell)
6 cyl	183ci 2954cc	3.0L	3.504" 89mm	1994-08	OHV (12 Valve) Ford (Vulcan) Eng. 8U Series, Vin U, V	F-48		
6 cyl	244ci 4016cc	4.0L	3.953" 100.4mm	1991-00	OHV Ford Eng. 8X, ZZL Series, Vin X (Cam Bearing Set w/ Special Wide No. 4 Position)	F-50 F-50A		
METROPOLITAN-NASH								
4 cyl	91ci 1489cc	1.5L	-	1954-62	OHV Metropolitan-Nash Eng. Series 1-4	DA-2		
MG (BRITISH LEYLAND LTD.)								
4 cyl	67ci 1098cc	1.1L	2.539" 64.5mm	1962-67	OHV MG Eng. 10CC, 10CG, 10GR Series	BL-1		
4 cyl	78ci 1275cc	1.3L	2.780" 70.6mm	1967-74	OHV MG Eng. 12CC, 12CD, 12CE, 12CJ, 12G, 12H Series	BL-1		
4 cyl	91ci 1489cc	1.5L	2.874" 73mm	1954-62	OHV MG Eng.	DA-2		
4 cyl	97ci 1588cc	1.6L	2.968" 75.4mm	1958-62	OHV MG Eng.	DA-2		

* Denotes (OHC) Repair Bearing, Check "Aluminum Overhead Cam Accessories" Section For Tool Information

** Denotes Auxiliary / Balance Shaft Bearing.

"und" Denotes Undersized ID

CAMSHAFT BEARINGS

DISPLACEMENT				YEAR	GENERAL APPLICATION DATA (ENGINE SERIES/MAKE/MODEL)	CAMSHAFT BEARING SET		
CYL.	CI/CC.	L	BORE			STD.	HI-PERF.	OHC
MG (BRITISH LEYLAND LTD.) (Cont.)								
4 cyl	99ci 1622cc	1.6L	3.000" 76.2mm	1961-68	OHV MG Eng.	DA-2		
4 cyl	108.9ci 1798cc	1.8L	3.159" 80.3mm	1962-81	OHV MG Eng. 18G, 18GA, 18GB, 18GF, 18GH, 18GJ, 18GK, 18V Series	DA-2		
8 cyl	215.4ci 3528cc	3.5L	3.500" 88.9mm	1974-77	OHV Buick Eng. Vin 1	B-11		
MILITARY STANDARD								
4 cyl	124ci	2.0L	3.250" 82.6mm	ALL	J.I. Case (MOB) Eng. VAE Series	CA-3		
4 cyl	125ci	2.0L	3.250" 82.6mm	ALL	Waukesha Eng. 180GB Series	WA-4		
4 cyl	133ci	2.2L	3.250" 82.6mm	ALL	Waukesha Eng. FCB-4 Series	WA-4		
4 cyl	133ci	2.2L	3.250" 82.6mm	ALL	Hercules Eng. IXB-ER Series	WA-3		
4 cyl	134ci	2.2L	3.125" 79.4mm	ALL	Willys/Jeep (F-Head)/(L-Head) Eng.	J-1		
4 cyl	139ci	2.3L	3.438" 87.3mm	ALL	Waukesha Eng. 180GM Series	WA-4		
4 cyl	142ci	2.3L	3.875" 98.4mm	ALL	Ford (Mutt) Eng. M151 Series	F-25		
4 cyl	145ci	2.4L	3.250" 82.6mm	ALL	OHV Continental Eng. FS45, FS145 Series	CO-8		
4 cyl	152ci	2.5L	3.875" 98.4mm	ALL	IHC Eng. 4-152, 4-152T, B-152 Series	IN-11		
4 cyl	153ci	2.5L	3.438" 87.3mm	ALL	Buda Eng. 4MB-153 Series	BU-2		
3 cyl	159ci	2.6L	3.875" 98.4mm	ALL	Detroit Supercharged Diesel Eng. 3-53, 3-53N Series (Cam Bearing & Balance Shaft Set) (+.010 OD, Cam Bearing & Balance Shaft Set)	DE-2A** DE-2AR1		
4 cyl	162ci	2.7L	3.438" 87.3mm	ALL	Continental (L-Head) Eng. FS162 Series	CO-8		
6 cyl	186ci	3.1L	3.250" 82.6mm	ALL	Waukesha Eng. 185GB Series	WA-4		
6 cyl	209ci	3.4L	3.438" 87.3mm	ALL	Waukesha Eng. 185GM Series	WA-4		
6 cyl	217.8ci	3.6L	3.250" 82.6mm	ALL	Chrysler (L-Head) Eng.	PD-1		
6 cyl	218ci	3.6L	3.250" 82.6mm	ALL	Continental Eng. FS218 Series	K-1		
6 cyl	218ci	3.6L	3.375" 85.7mm	ALL	OHV Chrysler Eng. 905A Series	PD-3		
4 cyl	226ci	3.7L	4.000" 101.6mm	ALL	Hercules Eng. JX4LD-ER Series	HE-1		
6 cyl	230ci	3.8L	3.250" 82.6mm	ALL	OHV Chrysler Eng. IND-931 Series	PD-1		
6 cyl	230ci	3.8L	3.438" 87.3mm	ALL	Buda Eng. 6MB-230 Series	BU-2		
6 cyl	237ci	3.9L	3.438" 87.3mm	ALL	Hercules Eng. QXLD-ER Series	BU-2		
8 cyl	239ci	3.9L	3.188" 80.98mm	ALL	Ford (Flathead)/(L-Head) Eng.	F-1		

* Denotes (OHC) Repair Bearing, Check "Aluminum Overhead Cam Accessories" Section For Tool Information

** Denotes Auxiliary / Balance Shaft Bearing.

"und" Denotes Undersized ID

CAMSHAFT BEARINGS

DISPLACEMENT				YEAR	GENERAL APPLICATION DATA (ENGINE SERIES/MAKE/MODEL)	CAMSHAFT BEARING SET		
CYL.	CI./CC.	L	BORE			STD.	HI-PERF.	OHC
MILITARY STANDARD (Cont.)								
6 cyl	244ci 3996cc	4.0L	3.438" 87.3mm	ALL	Continental Eng. 6-244-MS, 6-2444-S, FS244 Series	K-1		
6 cyl	251ci	4.1L	3.438" 87.3mm	ALL	Chrysler Eng. IND-908A, JXAL2-ER, U225 Series	PD-3		
8 cyl	283ci	4.6L	3.875" 98.4mm	ALL	OHV Chevrolet Eng.	CH-8	CHP-8 or CHP-8T (Coated)	
6 cyl	302ci	5.0L	4.000" 101.6mm	ALL	OHV GMC Eng.	CH-2		
8 cyl	302ci	5.0L	4.000" 101.6mm	ALL	OHV Chevrolet Eng.	CH-8	CHP-8 or CHP-8T (Coated)	
6 cyl	339ci	5.6L	4.000" 101.6mm	ALL	Hercules Eng. JXLD-ER Series	HE-1		
8 cyl	361ci	5.9L	4.125" 104.8mm	ALL	OHV Chrysler Eng. (+.010 OD)	PD-17	PDP-17 or PDP-17T (Coated) PDP-17R1	
8 cyl	534ci	8.8L	4.500" 114.3mm	ALL	OHV Ford Eng.	F-16		
MITSUBISHI								
4 cyl	- 1198cc	1.2L	2.685" 68.2mm	1984-88	SOHC Mitsubishi Eng. 4G16, G16B Series			MIA-3* (Full Round)
4 cyl	- 1244cc	1.2L	2.736" 69.5mm	1983-88	OHV Mitsubishi Eng. 4G11, G11B Series			MIA-3* (Full Round)
4 cyl	- 1298cc	1.3L	2.795" 71mm	1984-88	SOHC Mitsubishi Eng. 4G13, G13B Series			MIA-3* (Full Round)
4 cyl	86ci 1410cc	1.4L	2.913" 74mm	1983-88	SOHC Mitsubishi Eng. 4G12, G12B Series			MIA-3* (Full Round)
4 cyl	90ci 1468cc	1.5L	2.972" 75.5mm	1985-94	SOHC (8 Valve) Mitsubishi Eng. 4G15, G4AJ, G4DJ, G15B Series, Vin J, K, X			MIA-3* (Full Round)
4 cyl	98ci 1597cc	1.6L	3.028" 76.9mm	1985-88	SOHC (8 Valve) Mitsubishi Turbo Eng. G32B-T Series, Vin F (Cam Bearing Set w/ Heavy Wall, +.020 OD)			MIA-1* (1/2 Shell) MIA-2* (1/2 Shell)
4 cyl	- 1795cc	1.8L	3.173" 80.6mm	1983-88	SOHC (8 Valve) Mitsubishi Eng. G62B, G62B-T Series (Includes Turbo), Vin 4, G (Cam Bearing Set w/ Heavy Wall, +.020 OD)			MIA-1* (1/2 Shell) MIA-2* (1/2 Shell)
4 cyl	- 1855cc	1.9L	3.1890" 81mm	1973-78	SOHC Mitsubishi Eng. 4G51, G51B Series (Auxiliary Shaft Set)	MIG-2**		
4 cyl	- 1995cc	2.0L	3.307" 84mm	1973-88	SOHC Mitsubishi Eng. 4G52, G52B Series (Balance Shaft Set) (Balance Shaft Bearing w/ .173 Oversize OD) (Balance Shaft Elim)	MIG-2** MIG-2-1R MIG-2E**		MIA-4* (1/2 Shell)
4 cyl	122ci 1997cc	2.0L	3.346" 85mm	1983-93	SOHC (8 Valve) Mitsubishi Eng. 4G63, G63B Series, Vin 5, D, V (Balance Shaft Set)	MIG-3**		
4 cyl	122ci 1997cc	2.0L	3.346" 85mm	1989-99	DOHC (16 Valve) Mitsubishi Eng. 4G63, 4G63T, G63B, G63BT Series (Includes Turbo), Vin E, F, R, U (Balance Shaft Set)	MIG-3**		
4 cyl	143ci 2346cc	2.3L	3.587" 91.1mm	1983-85	SOHC Mitsubishi Diesel/Turbo-Diesel Eng. 4D55, 4D55T Series, Vin 9, J (Auxiliary Shaft Set) (Balance Shaft Bearing w/ .173 Oversize OD) (Balance Shaft Elim)	MIG-2** MIG-2-1R MIG-2E**		

* Denotes (OHC) Repair Bearing, Check "Aluminum Overhead Cam Accessories" Section For Tool Information

** Denotes Auxiliary / Balance Shaft Bearing.

"und" Denotes Undersized ID

CAMSHAFT BEARINGS

DISPLACEMENT				YEAR	GENERAL APPLICATION DATA (ENGINE SERIES/MAKE/MODEL)	CAMSHAFT BEARING SET		
CYL.	CI/CC.	L	BORE			STD.	HI-PERF.	OHC
MITSUBISHI (Cont.)								
4 cyl	- 2351cc	2.4L	3.406" 86.5mm	1985-96	SOHC (8 Valve) Mitsubishi Eng. 4G64, G64B Series, Vin G, L, W (Cam Bearing Set w/ Heavy Wall, +.020 OD) (Balance Shaft Set)	MIG-3**		MIA-1* (1/2 Shell) MIA-2* (1/2 Shell)
4 cyl	- 2351cc	2.4L	3.406" 86.5mm	1993-05	SOHC/DOHC (16 Valve) Mitsubishi Eng. 4G64, G64B Series, Vin G (Balance Shaft Set)	MIG-3**		
4 cyl	- 2384cc	2.4L	3.465" 88mm	1975-81	OHV Mitsubishi Eng. 4G53 Series (Balance Shaft Set) (Balance Shaft Bearing w/ .173 Oversize OD) (Balance Shaft Elim)	MIG-2** MIG-2-1R MIG-2E**		
4 cyl	- 2477cc	2.5L	3.587" 91.1mm	1985-88	OHV Mitsubishi Turbo Diesel Eng. 4D56 Series (Balance Shaft Set) (Balance Shaft Bearing w/ .173 Oversize OD) (Balance Shaft Elim)	MIG-2** MIG-2-1R MIG-2E**		
4 cyl	156ci 2555cc	2.6L	3.587" 91.1mm	1983-89	SOHC (8 Valve) Mitsubishi Eng. 4G54, G54B, G54T, G54B-T Series (Includes Turbo), Vin 7, E, H, N (Cam Bearing Set w/ Heavy Wall, +.020 OD) (Balance Shaft Set) (Balance Shaft Bearing w/ .173 Oversize OD) (Balance Shaft Elim)	MIG-2** MIG-2-1R MIG-2E**		MIA-1* (1/2 Shell) MIA-2* (1/2 Shell)
6 cyl	181ci 2972cc	3.0L	3.587" 91.1mm	1988-05	SOHC Mitsubishi Eng. 6G72, 6G72T Series (Includes Turbo), Vin F, H, L, P, S (1 Cam Set Per Cyl. Head)			MIA-5* (1/2 Shell)
MORRIS (BRITISH LEYLAND LTD.)								
4 cyl	67ci 1098cc	1.1L	2.542" 64.6mm	1963-74	OHV Morris/British Leyland Eng.	BL-1		
4 cyl	73.3ci 1198cc	1.2L	2.539" 64.5mm	1954-61	Morris/British Leyland Eng.	DA-2		
4 cyl	91ci 1489cc	1.5L	2.874" 73mm	1954-62	OHV Morris/British Leyland Eng.	DA-2		
4 cyl	91.6ci 1500cc	1.5L	2.874" 73mm	1962	Morris/British Leyland Eng.	DA-2		
4 cyl	99ci 1622cc	1.6L	3.000" 76.2mm	1962-71	OHV Morris/British Leyland Eng.	DA-2		
4 cyl	109.8ci 1798cc	1.8L	3.160" 80.3mm	1963-66	Morris/British Leyland Eng.	DA-2		
NISSAN (INFINITI, DATSUN)								
4 cyl	60ci 988cc	1.0L	2.874" 73mm	1965-71	OHV Nissan Eng. A10 Series	DA-1		
4 cyl	72ci 1171cc	1.2L	2.874" 73mm	1970-73	OHV Nissan Eng. A12 Series	DA-1		
4 cyl	73ci 1189cc	1.2L	2.874" 73mm	1959-65	OHV Nissan Eng. E1 Series	DA-2		
4 cyl	75.4ci 1237cc	1.2L	2.953" 75mm	1979-82	OHV Nissan Eng. A12A Series, Vin C	DA-1		
4 cyl	79ci 1288cc	1.3L	2.874" 73mm	1972-74	OHV Nissan Eng. A13 Series, Vin H	DA-1		
4 cyl	79ci 1299cc	1.3L	2.874" 73mm	1963-69	OHV Nissan Eng. J13 Series	DA-2		
4 cyl	- 1270cc	1.3L	2.992" 76mm	1981-90	SOHC Nissan Eng. E13 Series			NIA-4* (Full Round)
4 cyl	85ci 1397cc	1.4L	2.992" 76mm	1975-82	OHV Nissan Eng. A14 Series, Vin H, P	DA-1		

* Denotes (OHC) Repair Bearing, Check "Aluminum Overhead Cam Accessories" Section For Tool Information

** Denotes Auxiliary / Balance Shaft Bearing.

"und" Denotes Undersized ID

CAMSHAFT BEARINGS

DISPLACEMENT				YEAR	GENERAL APPLICATION DATA (ENGINE SERIES/MAKE/MODEL)	CAMSHAFT BEARING SET		
CYL.	CI./CC.	L	BORE			STD.	HI-PERF.	OHC
NISSAN (INFINITI, DATSUN) (Cont.)								
4 cyl	90.5ci 1483cc	1.5L	3.071" 78mm	1971-90	OHV Nissan Eng. J15 Series	DA-2		
4 cyl	90.8ci 1488cc	1.5L	2.992" 76mm	1979-82	OHV Nissan Eng. A15 Series, Vin P	DA-1		
4 cyl	- 1488cc	1.5L	2.992" 76mm	1982-84	SOHC Nissan Eng. E15, E15S, E15T Series (Includes Turbo), Vin H, M			NIA-4* (Full Round)
4 cyl	90.8ci 1488cc	1.5L	3.071" 78mm	1960-65	OHV Datsun Eng. G15 Series	DA-3A		
4 cyl	95.6ci 1567cc	1.6L	3.071" 78mm	1972-82	OHV Nissan Eng. J16 Series	DA-2		
4 cyl	97ci 1597cc	1.6L	2.992" 76mm	1983-88	SOHC (8 Valve) Nissan Eng. E16, E16I, E16S Series, Vin M, P			NIA-4* (Full Round)
4 cyl	97ci 1597cc	1.6L	2.992" 76mm	1989-90	SOHC (12 Valve) Nissan Eng. GA16I Series, Vin G			NIA-1* (Full Round)
4 cyl	97ci 1595cc	1.6L	3.433" 87.2mm	1966-70	OHV Nissan Eng. R, R16 Series	DA-3A		
4 cyl	- 1751cc	1.8L	3.169" 80.5mm	1978-91	OHV Nissan Eng. J18 Series	DA-2		
4 cyl	- 1809cc	1.8L	3.268" 83mm	1984-87	SOHC (8 Valve) Nissan Turbo Eng. CA18ET Series, Vin C			NIA-5* (Full Round)
4 cyl	- 1809cc	1.8L	3.268" 83mm	1988-89	DOHC (16 Valve) Nissan Eng. CA18DE Series, Vin C (1 Cam Set Per Cyl. Head)			NIA-5* (Full Round)
4 cyl	114.9ci 1883cc	1.9L	3.346" 85mm	1960-65	Nissan/Datsun Eng. H Series	DA-3A		
4 cyl	119ci 1952cc	2.0L	3.346" 85mm	1974-86	SOHC Nissan Eng. L20B, Z20, Z20E, Z20S Series, Vin F, H, P			NIA-6* (1/2 Shell)
4 cyl	121ci 1982cc	2.0L	3.433" 87.2mm	1967-92	OHV Nissan Eng. H20, U20 Series	DA-3A		
4 cyl	121.5ci 1991cc	2.0L	3.270" 83mm	1963-83	OHV Nissan Diesel Eng. SD20 Series	DA-3A		
4 cyl	122ci 1974cc	2.0L	3.327" 84.5mm	1982-89	SOHC Nissan Eng. CA20E, CA20S Series, Vin H, P			NIA-5* (Full Round)
4 cyl	- 2164cc	2.2L	3.268" 83mm	1963-88	OHV Nissan Diesel Eng. SD22 Series, Vin S	DA-3A		
4 cyl	- 2187cc	2.2L	3.425" 87mm	1981-83	SOHC Nissan Eng. Z22, Z22E, Z22S Series, Vin M, R			NIA-6* (1/2 Shell)
4 cyl	- 2289cc	2.3L	3.504" 89mm	1981-90	OHV Nissan Diesel Eng. SD23, TD23 Series	DA-3A		
4 cyl	- 2389cc	2.4L	3.504" 89mm	1983-89	SOHC (8 Valve) Nissan Eng. Z24, Z24I, Z24S Series, Vin N, S			NIA-6* (1/2 Shell)
4 cyl	- 2488cc	2.5L	3.504" 89mm	1983-86	OHV Nissan Diesel Eng. SD25 Series, Vin J	DA-3A		
4 cyl	152ci 2494cc	2.5L	3.504" 89mm	1986-90	Nissan Diesel Eng. TD25 Series	DA-3A		
4 cyl	163ci 2663cc	2.7L	3.780" 96mm	1986-90	OHV Nissan Diesel Eng. TD27 Series	DA-3A		
4 cyl	180ci 2953cc	3.0L	3.780" 96mm	ALL	DOHC (16 Valve) Nissan Eng. ZD30DDT (Turbo Non Intercooled) ZD30DDTI (Turbo Intercooled) Series (Auxiliary / Balance Shaft Set)	NIG-1**		

* Denotes (OHC) Repair Bearing, Check "Aluminum Overhead Cam Accessories" Section For Tool Information

** Denotes Auxiliary / Balance Shaft Bearing.

"und" Denotes Undersized ID

CAMSHAFT BEARINGS

DISPLACEMENT				YEAR	GENERAL APPLICATION DATA (ENGINE SERIES/MAKE/MODEL)	CAMSHAFT BEARING SET		
CYL.	CI/CC.	L	BORE			STD.	HI-PERF.	OHC
NISSAN (INFINITI, DATSUN) (Cont.)								
6 cyl	181ci 2960cc	3.0L	3.425" 87mm	1984-86	SOHC Nissan Eng. VG30, VG30E, VG30T Series (Includes Turbo), Vin C, H (Cam Bearing Set, Left Bank) (Cam Bearing Set, Right Bank)			NIA-2L* (Full Round) NIA-2R* (Full Round)
6 cyl	181ci 2960cc	3.0L	3.425" 87mm	1987-01	SOHC/DOHC Nissan Eng. VE30DE, VG30, VG30DE, VG30DETT, VG30E, VG30I, VG30T Series (Includes Turbo/Twin Turbo), Vin 1, A, C, E, H, R, W (Cam Bearing Set, Left Bank) (Cam Bearing Set, Right Bank)			NIA-3L* (Full Round) NIA-2R* (Full Round)
6 cyl	198.1ci 3246cc	3.2L	3.268" 83mm	1966-90	OHV Nissan Diesel/Turbo-Diesel Eng. CN6-33, SD33, SD33T Series	DA-5		
NUFFIELD TRACTOR (Also see BRITISH LEYLAND LTD.)								
4 cyl	99ci 1622cc	1.6L	3.000" 76.2mm	1961-71	Gas/Diesel Eng. 154 Series	DA-2		
OLIVER TRACTOR & POWER UNITS								
4 cyl	91ci	1.5L	2.875" 73mm	ALL	Continental (L-Head) Eng. 91, PY91, Y4091 Series	CO-3		
4 cyl	129ci	2.1L	3.313" 84.1mm	1955-59	Oliver Gas/Diesel Eng. 166HC, 166HC Super, 550DSL, 550HC, 660DSL, 66OHC Series	WA-4		
4 cyl	140ci	2.3L	3.188" 80.98mm	ALL	Continental (L-Head) Eng. F140 Series	CO-8		
4 cyl	144ci	2.4L	3.500" 88.9mm	1955-62	Oliver Gas/Diesel Eng. 166HC, 166HC Super, 550DSL, 550HC, 660DSL, 66OHC Series	WA-4		
4 cyl	155ci	2.5L	3.625" 92.1mm	1959-70	Oliver Gas/Diesel Eng. 166HC, 166HC Super, 550DSL, 550HC, 660DSL, 66OHC Series	WA-4		
6 cyl	194ci	3.2L	3.313" 84.2mm	1955-59	Waukesha Eng. 177HC, 177LP Series	WA-4		
4 cyl	198ci	3.3L	3.750" 95.3mm	ALL	Hercules Diesel Eng. DD198, D2120 Series	HE-8		
4 cyl	205ci	3.4L	3.250" 82.6mm	ALL	Hercules Eng. QXB3 Series	HE-5		
6 cyl	209ci	3.4L	3.188" 80.98mm	ALL	Continental (L-Head) Eng. F209 Series	K-1		
6 cyl	216ci	3.5L	3.500" 88.9mm	1959-69	Waukesha Eng. 177HC, 177LP Series	WA-4		
6 cyl	226ci	3.7L	3.313" 84.1mm	ALL	OHV Continental (Flex) Eng. F226 Series	K-1		
6 cyl	228ci	3.7L	3.375" 85.7mm	ALL	Hercules Eng. JXA, JXC, JXD Series	HE-1		
6 cyl	231ci	3.8L	3.500" 88.9mm	1955-62	Waukesha Gas/Diesel Eng. 188HC, 188HC Super Series (Early, One Bearing)	WA-4		
6 cyl	231ci	3.8L	3.500" 88.9mm	1955-62	Waukesha Eng. 188HC, 188HC Super Series (Late, Four Bearings)	WA-7		
6 cyl	232ci	3.8L	3.625" 92.1mm	1955-70	Waukesha Gas/Diesel Eng. 1550, 1555, 177D, 177D Super, 177HC Series	WA-4		
6 cyl	244ci	4.0L	3.438" 87.3mm	ALL	Continental (L-Head) Eng. F244 Series	K-1		
6 cyl	251.6ci	4.1L	3.438" 87.3mm	ALL	Chrysler (L-Head) Eng. 430, 431, 525, 535, 545 Series	PD-3		
6 cyl	263ci	4.3L	3.625" 92.1mm	ALL	Hercules Eng. JXA, JXC, JXD Series	HE-1		

* Denotes (OHC) Repair Bearing, Check "Aluminum Overhead Cam Accessories" Section For Tool Information

** Denotes Auxiliary / Balance Shaft Bearing.

"und" Denotes Undersized ID

CAMSHAFT BEARINGS

DISPLACEMENT				YEAR	GENERAL APPLICATION DATA (ENGINE SERIES/MAKE/MODEL)	CAMSHAFT BEARING SET		
CYL.	CI./CC.	L	BORE			STD.	HI-PERF.	OHC
OLIVER TRACTOR & POWER UNITS (Cont.)								
6 cyl	265ci	4.3L	3.750" 95.3mm	1955-59	Waukesha Eng. 188HC, 188HC Super, 188LP Series (Early, One Bearing)	WA-4		
6 cyl	265ci	4.3L	3.750" 95.3mm	1955-59	Waukesha Eng. 188HC, 188HC Super, 188LP Series (Late, Four Bearings)	WA-7		
6 cyl	283ci	4.6L	3.875" 98.4mm	ALL	Oliver/Waukesha Gas/Diesel Eng. 185GB, 185GM Series (Early, One Bearing)	WA-4		
6 cyl	283ci	4.6L	3.875" 98.4mm	ALL	Oliver/Waukesha Gas/Diesel Eng. 185GB, 185GM Series (Late, Four Bearing)	WA-7		
6 cyl	302ci	5.0L	4.000" 101.6mm	1955-59	Oliver/Waukesha Diesel Eng. 199D, 199D Super, 950D, 950DSL, 99D Series (Early, One Bearing)	WA-4		
6 cyl	302ci	5.0L	4.000" 101.6mm	1955-59	Oliver/Waukesha Gas/Diesel Eng. 99HC, 199HC Super, 950HC Series (Late, Four Bearing)	WA-7		
6 cyl	310ci	5.1L	3.875" 98.4mm	ALL	Oliver/Waukesha Gas/Diesel Eng. 185GB, 185GM Series (Early, One Bearing)	WA-4		
6 cyl	310ci	5.1L	3.875" 98.4mm	ALL	Oliver/Waukesha Gas/Diesel Eng. 185GB, 185GM Series (Late, Four Bearing)	WA-7		
6 cyl	320ci	5.2L	4.000" 101.6mm	ALL	Hercules Eng. JXA, JXC, JXD Series	HE-1		
6 cyl	322ci	5.3L	4.125" 104.8mm	1955-62	Oliver/Waukesha Diesel Eng. 199D, 199D Super, 950D, 950DSL, 99D Series	WA-4		
6 cyl	339ci	5.6L	4.000" 101.6mm	ALL	Hercules Eng. JXLD Series (1.057" Length On No. 1 And 4 Positions)	HE-8		
6 cyl	339ci	5.6L	4.000" 101.6mm	ALL	Hercules Eng. JXLD Series (1.125" Length On No. 1 And 4 Positions)	HE-1		
8 cyl	573ci	9.4L	4.500" 114.3mm	ALL	Caterpillar Eng. 3150 Series	CAT-2		
ONAN								
2 cyl	50ci 820cc	0.8L	3.250" 82.6mm	ALL	CCK, CCK-MSV-106F, CCKB, Super CCK Series	ON-1		
OPEL								
4 cyl	91ci 1491cc	1.5L	3.248" 82.5mm	1967-68	SOHC Opel Eng. 1.5, 1.5S Series (Triangle Mark On Left Side Of Head)	OP-3		
4 cyl	96.6ci 1584cc	1.6L	3.346" 85mm	1970-81	SOHC Opel Eng. 1.6S Series (Triangle Mark On Left Side Of Head)	OP-3		
4 cyl	103.4ci 1698cc	1.7L	3.465" 88mm	1965-81	SOHC Opel Eng. 1.7S Series (Triangle Mark On Left Side Of Head)	OP-3		
4 cyl	110ci 1796cc	1.8L	3.339" 84.8mm	1976-82	SOHC Opel Eng. 1.8E, N, S Series (Auxiliary Shaft Set)	CHG-14**		
4 cyl	116ci 1897cc	1.9L	3.661" 93mm	1965-75	SOHC Opel Eng. 1.9S Series, Vin N (Triangle Mark On Left Side Of Head, Three Bearing)	OP-3		
4 cyl	116ci 1897cc	1.9L	3.661" 93mm	1971-75	SOHC Opel Eng. 1.9S Series, Vin N (Four Bearing)	OP-5		
REO MOTOR TRUCK								
6 cyl	255ci	4.2L	3.625" 92.1mm	ALL	Reo Eng. OA110, OA123, OA130, OA145, OA255 Series	R-1		
6 cyl	292ci	4.8L	3.875" 98.4mm	ALL	Reo Eng. OA255 Series	R-1		
6 cyl	331ci	5.4L	4.125" 104.8mm	ALL	Reo Eng. OA331, OH160, OH170 Series	R-1		
6 cyl	362ci	5.9L	4.250" 108mm	ALL	Reo Eng. 6-186, OH185, OH186 Series	R-1		

* Denotes (OHC) Repair Bearing, Check "Aluminum Overhead Cam Accessories" Section For Tool Information

** Denotes Auxiliary / Balance Shaft Bearing.

"und" Denotes Undersized ID

CAMSHAFT BEARINGS

DISPLACEMENT				YEAR	GENERAL APPLICATION DATA (ENGINE SERIES/MAKE/MODEL)	CAMSHAFT BEARING SET		
CYL.	CI/CC.	L	BORE			STD.	HI-PERF.	OHC
REO MOTOR TRUCK (Cont.)								
6 cyl	400ci	6.6L	4.250" 108mm	ALL	Reo Eng. 6-190, 6-200, OH200 Series	R-1		
RILEY								
4 cyl	91ci 1489cc	1.5L	2.874" 73mm	1958-63	OHV British Leyland Eng. 14H Series	DA-2		
4 cyl	99ci 1622cc	1.6L	3.000" 76.2mm	1961-69	OHV British Leyland Eng.	DA-2		
ROVER (LAND ROVER)								
8 cyl	215ci 3528cc	3.5L	3.500" 88.9mm	1969-80	OHV Rover Eng.	B-11		
8 cyl	- 3950cc	4.0L	3.701" 94mm	1995-02	OHV Rover Eng. Vin 2, 5	LR-1		
8 cyl	278ci 4554cc	4.6L	3.701" 94mm	1996-04	OHV Rover Eng. Vin 4, 6, 9	LR-1		
SAAB								
4 cyl	91ci 1498cc	1.5L	3.701" 94mm	1967-70	OHV Ford Europe Eng. 95, 96 Series	F-42		
4 cyl	104ci 1698cc	1.7L	3.543" 90mm	1969-74	OHV Ford Europe Eng. 95, 96 Series	F-42		
STUDEBAKER								
6 cyl	194ci 3180cc	3.2L	3.563" 90.5mm	1965-66	OHV Chevrolet Eng.	CH-7		
6 cyl	230ci 3769cc	3.8L	3.875" 98.4mm	1966	OHV Chevrolet Eng.	CH-7		
8 cyl	283ci 4638cc	4.7L	3.875" 98.4mm	1965-66	OHV Chevrolet Eng.	CH-8	CHP-8 or CHP-8T (Coated)	
SUZUKI								
4 cyl	81ci 1325cc	1.3L	2.913" 74mm	1985-97	SOHC (8 Valve) Subaru Eng. G13A Series, Vin 2, 3, 5			SA-1* (Full Round)
TOYOTA								
4 cyl	- 933cc	0.9L	2.835" 72mm	1970-86	OHV Toyota Eng. 2K Series	TO-3		
4 cyl	66ci 1077cc	1.1L	2.953" 75mm	1968-69	OHV Toyota Eng. KC Series	TO-3		
4 cyl	71ci 1166cc	1.2L	2.953" 75mm	1969-79	OHV Toyota Eng. 3KC Series, Vin K	TO-3		
4 cyl	- 1290cc	1.3L	2.953" 75mm	1981-84	OHV Toyota Eng. 4KC, 4KE Series, Vin K	TO-3		
4 cyl	85.9ci 1407cc	1.4L	3.149" 80mm	1970-79	OHV Toyota Eng. T, TJ, TU Series	TO-7		
4 cyl	- 1490cc	1.5L	3.071" 78mm	1964-71	OHV Toyota Eng. 2R Series	TO-2		
4 cyl	- 1468cc	1.5L	3.169" 80.5mm	1984-88	OHV Toyota Eng. 5K Series	TO-3		
4 cyl	- 1587cc	1.6L	3.169" 80.5mm	1965-85	OHV Toyota Eng. 4R, 9R, 12J Series (Export Series)	TO-2		
4 cyl	97ci 1588cc	1.6L	3.346" 85mm	1970-85	SOHC Toyota Eng. 2T, 2TC, 2TJ, 2TU, 12T, 12TJ, 12TU Series, Vin T	TO-7		
4 cyl	97.2ci 1591cc	1.6L	3.386" 86mm	1968-72	OHV Toyota Eng. 7R, 7RB Series	TO-8		
					(Auxiliary / Balance Shaft Set)	TOG-8**		

* Denotes (OHC) Repair Bearing, Check "Aluminum Overhead Cam Accessories" Section For Tool Information

** Denotes Auxiliary / Balance Shaft Bearing.

"und" Denotes Undersized ID

CAMSHAFT BEARINGS

DISPLACEMENT				YEAR	GENERAL APPLICATION DATA (ENGINE SERIES/MAKE/MODEL)	CAMSHAFT BEARING SET		
CYL.	CI./CC.	L	BORE			STD.	HI-PERF.	OHC
TOYOTA (Cont.)								
4 cyl	- 1626cc	1.6L	3.386" 86mm	1983-88	OHV Toyota Eng. 1Y Series	TO-12		
4 cyl	104.2ci 1707cc	1.7L	3.386" 86mm	1970-73	OHV Toyota Eng. 6R, 6RB Series	TO-8		
4 cyl	- 1770cc	1.8L	3.346" 85mm	1980-86	OHV Toyota Eng. 3T, 3TC, 3TEU, 3TU, 13TJ, 13TU Series, Vin T	TO-7		
4 cyl	- 1812cc	1.8L	3.386" 86mm	1983-88	OHV Toyota Eng. 2Y Series	TO-12		
4 cyl	110.8ci 1808cc	1.8L	3.484" 88.5mm	1971-79	OHV Toyota Eng. 16R, RB, RJ, RU Series (Auxiliary / Balance Shaft Set)	TO-8 TOG-8**		
4 cyl	113ci 1858cc	1.9L	3.386" 86mm	1967-71	SOHC Toyota Eng. 8R, 8RC Series (Auxiliary / Balance Shaft Set)	TO-8 TOG-8**		
4 cyl	116ci 1897cc	1.9L	3.465" 88mm	1961-70	OHV Toyota Eng. 3RB, 3RC Series	TO-11		
4 cyl	120ci 1968cc	2.0L	3.484" 88.5mm	1972-74	SOHC Toyota Eng. 18RC Series, Vin R (Auxiliary / Balance Shaft Set)	TO-8 TOG-8**		
6 cyl	121ci 1988cc	2.0L	3.386" 86.1mm	1965-84	DOHC (24 Valve) Toyota Eng. 1M, 3M, M, MB, MC, MJ, MU Series	TO-8		
4 cyl	122ci 1998cc	2.0L	3.386" 86mm	1984-85	OHV Toyota Eng. 3YEC Series, Vin Y	TO-12		
4 cyl	121.7ci 1994cc	2.0L	3.465" 88mm	1967-88	OHV Toyota Eng. 5R Series	TO-11		
4 cyl	- 2164cc	2.2L	3.425" 87mm	1990-94	DOHC Toyota Eng. 5SFE Series (32 Tooth Gear), Vin S (Balance Shaft Set) (Balance Shaft Kit: Combines TOG-11 & TOG-11A)	TOG-11** TOG-11C**		
4 cyl	- 2164cc	2.2L	3.425" 87mm	1995-01	DOHC Toyota Eng. 5SFE Series (22 Tooth Gear), Vin G, S (Balance Shaft Set) (Balance Shaft Kit: Combines TOG-11 & TOG-11A)	TOG-11A** TOG-11C**		
4 cyl	- 2189cc	2.2L	3.484" 88.5mm	1975-80	SOHC Toyota Eng. 20R Series, Vin R (Auxiliary / Balance Shaft Set)	TOG-8**		TOA-1* (1/2 Shell)
4 cyl	- 2237cc	2.2L	3.583" 91mm	1986-90	OHV Toyota Eng. 4YEC Series, Vin Y	TO-12		
6 cyl	138ci 2253cc	2.3L	2.952" 74.9mm	1967-72	SOHC Toyota Eng. 2M Series (Auxiliary / Balance Shaft Set)	TO-8 TOG-9**		
4 cyl	- 2366cc	2.4L	3.622" 92mm	1981-95	SOHC Toyota Eng. 22R, 22RE, 22REC, 22RTEC Series (Includes Turbo), Vin R			TOA-1* (1/2 Shell)
6 cyl	156ci 2563cc	2.6L	3.150" 80mm	1971-80	SOHC Toyota Eng. 4M, 4ME Series, Vin M (Auxiliary / Balance Shaft Set)	TO-8 TOG-9**		
4 cyl	- 2694cc	2.7L	3.740" 95mm	1994-04	DOHC Toyota Eng. 3RZFE Series, Vin M, U (Auxiliary / Balance Shaft Set)	TOG-10**		
6 cyl	- 2759cc	2.8L	3.268" 83mm	1981-88	SOHC/DOHC Toyota Eng. 5ME, 5MGE Series, Vin M (Auxiliary / Balance Shaft Set)	TOG-9**		
4 cyl	- 2977cc	3.0L	3.740" 95mm	1986-90	OHV Toyota Diesel Eng. 11B, B Series	TO-15		
4 cyl	209ci 3431cc	3.4L	4.016" 102mm	1984-90	OHV Toyota Diesel/Turbo Diesel Eng. 3B, 13B, 13BT Series	TO-15		
4 cyl	- 3660cc	3.7L	4.016" 102mm	1988	OHV Toyota Diesel Eng. 14B, B Series	TO-15		

* Denotes (OHC) Repair Bearing, Check "Aluminum Overhead Cam Accessories" Section For Tool Information

** Denotes Auxiliary / Balance Shaft Bearing.

"und" Denotes Undersized ID

CAMSHAFT BEARINGS

CYL.	DISPLACEMENT			YEAR	GENERAL APPLICATION DATA (ENGINE SERIES/MAKE/MODEL)	CAMSHAFT BEARING SET		
	CI/CC.	L	BORE			STD.	HI-PERF.	OHC
TOYOTA (Cont.)								
6 cyl	237ci 3878cc	3.9L	3.543" 90mm	1954-74	OHV Toyota Eng. F Series, Vin F	TO-10		
6 cyl	- 3956cc	4.0L	3.701" 94mm	1988-92	OHV Toyota Eng. 3F, 3FE Series, Vin F	TO-10		
6 cyl	- 4227cc	4.2L	3.701" 94mm	1975-87	OHV Toyota Eng. 2F Series, Vin F	TO-10		
TRIUMPH								
8 cyl	- 3528cc	3.5L	3.500" 88.9mm	1980-82	OHV Rover (K-Series) Eng. Vin 5, V	B-11		
VOLKSWAGEN								
4 cyl	73ci 1192cc	1.2L	3.031" 77mm	1954-66	OHV VW Eng. (Air Cooled)	VW-1		
4 cyl	78ci 1285cc	1.3L	3.031" 77mm	1966	OHV VW Eng. F Series (Air Cooled)	VW-1		
4 cyl	79.1ci 1297cc	1.3L	2.952" 75mm	1973-81	SOHC VW Eng. 1300ZF Series (Auxiliary / Balance Shaft Set)	VWG-1**		
4 cyl	88.8ci 1457cc	1.5L	3.130" 79.5mm	1978-80	SOHC VW Eng. EH, FX Series (Auxiliary / Balance Shaft Set)	VWG-1**		
4 cyl	90ci 1471cc	1.5L	3.012" 76.5mm	1974-80	SOHC VW Gas/Diesel Eng. CK, FC, FG, XR, XS, XV, XW, XY, XZ Series (Auxiliary / Balance Shaft Set)	VWG-1**		
4 cyl	91ci 1493cc	1.5L	3.268" 83mm	1963-69	OHV VW Eng. H Series (Air Cooled)	VW-1		
4 cyl	97ci 1584cc	1.6L	3.366" 85.5mm	1966-80	OHV VW Eng. AD, AE, AF, AG, AH, AJ, AK, AL, AM, AS, B, C, P, T, U, X Series (Air Cooled)	VW-1		
4 cyl	97ci 1588cc	1.6L	3.130" 79.5mm	1976-80	SOHC VW Eng. EE, EJ, FN, YG, YH, YK Series (Auxiliary / Balance Shaft Set)	VWG-1**		
4 cyl	97ci 1588cc	1.6L	3.130" 79.5mm	1981-92	SOHC VW Diesel/Turbo-Diesel Eng. CR, CS, CY, IV, JK, MD, ME, MF Series, Vin G, H (Auxiliary / Balance Shaft Set)	VWG-1**		
4 cyl	104.6ci 1715cc	1.7L	3.130" 79.5mm	1981-84	SOHC VW Eng. EN, JF, WT Series, Vin A, B (Auxiliary / Balance Shaft Set)	VWG-1**		
4 cyl	109ci 1780cc	1.8L	3.189" 81mm	1983-98	SOHC VW Eng. 2H, ABG, ACC, GX, HT, JH, JN, MZ, PF, PG, RD, UM Series (Includes Supercharged), Vin A, B, C, E, G, K, N (Auxiliary / Balance Shaft Set)	VWG-1**		VWA-2* (1/2 Shell)
4 cyl	- 1780cc	1.8L	3.189" 81mm	1986-89	DOHC (16 Valve) VW Eng. PL Series, Vin B, C (Auxiliary / Balance Shaft Set)	VWG-1**		
5 cyl	- 2144cc	2.2L	3.130" 79.5mm	1983-84	SOHC VW Eng. KM, WE Series, Vin B			VWA-1* (1/2 Shell)
5 cyl	- 2226cc	2.2L	3.189" 81mm	1985-88	SOHC VW Eng. JT, KX Series, Vin B, E			VWA-1* (1/2 Shell)
VOLVO								
4 cyl	109ci 1780cc	1.8L	3.313" 84.1mm	1961-68	OHV Volvo Eng. B18A, B18B, B18D Series (Auxiliary / Balance Shaft Set)	VO-2**		
4 cyl	121ci 1986cc	2.0L	3.500" 88.9mm	1969-75	OHV Volvo Eng. B20A, B20B, B20E, B20F Series (Auxiliary / Balance Shaft Set)	VO-2**		
4 cyl	- 2127cc	2.1L	3.622" 92mm	1976-85	SOHC Volvo Eng. B21A, B21E, B21F, B21FT Series (Includes Turbo), Vin 1, 4, 41, 45 (1.265" Cam Housing w/ Cap & Saddle Design) (Auxiliary / Balance Shaft Set)	VO-2**		VOA-1* (1/2 Shell)
4 cyl	- 2316cc	2.3L	3.780" 96mm	1981-95	SOHC Volvo Eng. B23E, B23F, B23FT, B230F, B230FD, B230FS, B230FT Series (Includes Turbo), Vin 8, 88 (1.265" Cam Housing w/ Cap & Saddle Design)			VOA-1* (1/2 Shell)
6 cyl	182ci 2980cc	3.0L	3.500" 88.9mm	1969-75	OHV Volvo Eng. B30A, B30E, B30F Series	VO-3		

* Denotes (OHC) Repair Bearing, Check "Aluminum Overhead Cam Accessories" Section For Tool Information

** Denotes Auxiliary / Balance Shaft Bearing.

"und" Denotes Undersized ID

CAMSHAFT BEARINGS

DISPLACEMENT				YEAR	GENERAL APPLICATION DATA (ENGINE SERIES/MAKE/MODEL)	CAMSHAFT BEARING SET		
CYL.	CI./CC.	L	BORE			STD.	HI-PERF.	OHC
VOLVO-PENTA (MARINE)								
8 cyl	305ci 5012cc	5.0L	3.736" 95mm	ALL	OHV Chevrolet Eng. AQ200D, AQ225D, BB225A, BB225AV Series (Marine)	CH-8	CHP-8 or CHP-8T (Coated)	
8 cyl	350ci 5736cc	5.7L	4.000" 101.6mm	ALL	OHV Chevrole Eng. AQ260A, AQ290D, BB260A, BB260AV Series (Marine)	CH-8	CHP-8 or CHP-8T (Coated)	
WAUKESHA								
4 cyl	113ci	1.9L	3.000" 76.2mm	ALL	Waukesha Eng. 132, F, FC, FCK, FCL, FCS, FCX, FK, FKJ, FKL, FL, FLJ, FLS, FS FWJ Series	WA-3		
4 cyl	121ci	2.0L	3.313" 84.2mm	ALL	Waukesha Eng. 160 Series	WA-4		
4 cyl	125ci	2.0L	3.250" 82.6mm	ALL	Waukesha Eng. 180GB Series (Military Standard)	WA-4		
4 cyl	129ci	2.1L	3.313" 84.2mm	ALL	Waukesha Gas/Diesel Eng. 180DAB, 180DAC, 180DL, 180DLB, 180DLC, 180DLCU, 180GA, 180GB, 180GK, 180GS, 180KL, 180SB Series	WA-4		
4 cyl	133ci	2.2L	3.250" 82.6mm	ALL	Waukesha Eng. 132, FC, FCB-4, FCL, FCS, FCX, FK, FL, FLJ, FLS, FS, FWJ Series (Military Standard)	WA-3		
4 cyl	139ci	2.3L	3.438" 87.3mm	ALL	Waukesha Eng. 180GM Series (Military Standard)	WA-4		
4 cyl	144ci	2.4L	3.500" 88.9mm	ALL	Waukesha Gas/Diesel Eng. 180D, 180DKB, 180DLC, 180DLCU, 180GA, 180GK, 180GL, 180GLB, 180GLC, 180GS, 180KL Series	WA-4		
4 cyl	155ci	2.5L	3.625" 92.1mm	ALL	Waukesha Gas/Diesel Eng. 180DKB, 180G, 180GKB, 180GKBC, 180GKBU, D155, D155D, D155G, D155GA, D176, D176G, G155, G176, VRD155, VRG155, VRG176 Series	WA-4		
4 cyl	176ci	2.9L	3.625" 92.1mm	ALL	Waukesha Eng. D176, D176G, G176, VRG176 Series	WA-4		
6 cyl	186ci	3.0L	3.250" 82.6mm	ALL	Waukesha Eng. 185GB, 185GM Series (Military Standard)	WA-4		
6 cyl	194ci	3.2L	3.313" 84.2mm	ALL	Waukesha Gas/Diesel Eng. 185DAB, 185DAC, 185DLB, 185DLC, 185DLCU, 185DSB, 185DY, 185GA, 185GB Series	WA-4		
6 cyl	209ci	3.4L	3.438" 87.3mm	ALL	Waukesha Eng. 209, 185GB, 185GM Series (Military Standard)	WA-4		
6 cyl	216ci	3.5L	3.500" 88.9mm	ALL	Waukesha Gas/Diesel Eng. 185GL, 185GLB, 185GM, 185GS, 185KL, 185DLC, 185DLCU Series	WA-4		
4 cyl	220ci 3560cc	3.6L	3.858" 98mm	ALL	Waukesha Gas/Diesel/Turbocharged Diesel Eng. VRD220, VRD220S VRG220 Series (Except Engines With Hydraulic Pump) (Cam Bearing Set w/Expansion Plug DP-22-P)	WA-12		
6 cyl	232ci	3.8L	3.625" 92.1mm	ALL	Waukesha Gas/Diesel Eng. F232G, VRD232, VRG232 Series	WA-4		
6 cyl	263ci	4.3L	3.625" 92.1mm	ALL	Waukesha Eng. B Series	WA-4		
6 cyl	265ci	4.3L	3.750" 95.3mm	ALL	Waukesha Gas/Diesel/LPG Eng. 190DKB, 190KL, 190DLA, 190DLB, 190DLC, 190DLK, 190DLCA, 190DLCR, 190DLCU, 190DSB, 190GL, 190GLB, 190GLBU, 190GLC, 190GS, F265G, VRG265 Series	WA-4		
6 cyl	283ci	4.6L	3.875" 98.4mm	ALL	Waukesha Gas/Diesel/LPG Eng. F283G, VRD283, VRG283, VRD310, VRG310 Series	WA-7		
6 cyl	299ci	4.9L	3.313" 84.2mm	ALL	Waukesha Eng. 185DAB, 185DAC, 185DLB Series	WA-4		
6 cyl	302ci	5.0L	4.000" 101.6mm	ALL	Waukesha Gas/Diesel Eng. 190GK, 190KL, 195DLC, 195DLCA, 195DLCU, 195GL, 197DLC, 197DLCA, 197DLCS Series	WA-4		
6 cyl	310ci	5.1L	3.875" 98.4mm	ALL	Waukesha Gas/Diesel/LPG Eng. F310G, VRD310, VRD310S, VRG310 Series (Includes Turbo)	WA-7		
6 cyl	320ci	5.2L	4.125" 104.8mm	ALL	Waukesha Eng. 195GK, 195GKA, 195GKU Series	WA-4		

* Denotes (OHC) Repair Bearing, Check "Aluminum Overhead Cam Accessories" Section For Tool Information

** Denotes Auxiliary / Balance Shaft Bearing.

"und" Denotes Undersized ID

CAMSHAFT BEARINGS

DISPLACEMENT				YEAR	GENERAL APPLICATION DATA (ENGINE SERIES/MAKE/MODEL)	CAMSHAFT BEARING SET		
CYL.	CI/CC.	L	BORE			STD.	HI-PERF.	OHC
WAUKESHA (Cont.)								
6 cyl	330ci	5.3L	3.858" 98.4mm	ALL	Waukesha Eng. VRG330 CNG Series	WA-8		
6 cyl	330ci 534occ	5.3L	3.875" 98.4mm	ALL	Waukesha Diesel/Turbocharged Diesel Eng. VRD330, VRD330S Series	WA-8		
6 cyl	468ci	7.6L	4.250" 108mm	ALL	Waukesha Eng. 140HL, 140HS Series	WA-10		
6 cyl	501ci	8.2L	4.500" 114.3mm	ALL	Waukesha Eng. V Series	WA-11		
6 cyl	525ci	8.6L	4.500" 114.3mm	ALL	Waukesha Eng. 140GK, 140GS, 140GKB, 140HK Series	WA-10		
6 cyl	554ci	9.1L	4.625" 117.5mm	ALL	Waukesha Eng. 140GZ, 140GZB, 140GZC, 140GZU, F554G Series	WA-10		
6 cyl	638ci	10.5L	4.750" 120.7mm	ALL	Waukesha Eng. 145GS, 145HS Series	WA-11		
6 cyl	779ci	12.8L	5.250" 133.4mm	ALL	Waukesha Eng. 145GK, 145GKB, 145GKU, 145HK Series	WA-11		
6 cyl	817ci	13.4L	5.375" 136.5mm	ALL	Waukesha Eng. 145GZ, 145GZB, 145GZU, F817G Series	WA-11		
6 cyl	1013ci	16.6L	5.750" 146.1mm	ALL	Waukesha Eng. 6WAL, 6WALH Series	WA-9		
6 cyl	1196ci	19.6L	6.250" 158.8mm	ALL	Waukesha Eng. 6WAK, 6WAKB, 6WAKC, 6WAKD, 6WAKDB, 6WAKDBS, 6WAKDS, 6WAKH, 6WAKM, F1197G, F1197GR Series	WA-9		
SPECIALTY AFTERMARKET BLOCKS								
8 cyl	-	-	-	ALL	Dart Eng. Little "M" Block (2.000" Hsg., OD Groove w/ 3 Hole, 120 Degree Spacing) (+.010 OD)		DT-1 or DT-1T (Coated) DT-1TR1 (Coated)	
8 cyl	-	-	-	ALL	Dart Eng. GMC SHP Block (2.000" Hsg., OD Groove w/ 3 Hole, 120 Degree Spacing) (+.010 OD)		DT-1 or DT-1T (Coated) DT-1TR1 (Coated)	
8 cyl	-	-	-	ALL	Dart Eng. Iron Eagle (2.120" Hsg., OD Groove w/ 3 Hole, 120 Degree Spacing)		GMP-2T (Coated)	
8 cyl	-	-	-	ALL	Dart Eng. Big "M" Block (2.120" Hsg., OD Groove w/ 3 Hole, 120 Degree Spacing)		GMP-12LT (Coated)	
8 cyl	-	-	-	ALL	Dart Eng. Ford SHP Block (2.204" Hsg., OD Groove w/ 3 Hole, 120 Degree Spacing) (+.010 OD)		SBF-1T (Coated) SBF-1R1T (Coated)	
8 cyl	-	-	-	ALL	Dart Eng. Ford SVO Block (2.204" Hsg., OD Groove w/ 3 Hole, 120 Degree Spacing) (+.010 OD)		SBF-1T (Coated) SBF-1R1T (Coated)	
8 cyl	-	-	-	ALL	Ford Eng. Genesis (2.0395 Hsg.) (+.010 OD)		FP-01 FP-01R1	
8 cyl	-	-	-	ALL	GMC Block (2.125" Cam Journal)		GMP-3 or GMP-3T (Coated)	
8 cyl	-	-	-	ALL	GMC LSX Block (.700" Wide No. 1-5 Position)	GM-9	GMP-9 or GMP-9T (Coated)	
8 cyl	-	-	-	ALL	GMC LSX Block (.775" Wide No. 1-5 Position)	GM-25	GMP-25 or GMP-25T (Coated)	

* Denotes (OHC) Repair Bearing, Check "Aluminum Overhead Cam Accessories" Section For Tool Information

** Denotes Auxiliary / Balance Shaft Bearing.

"und" Denotes Undersized ID

CAMSHAFT BEARINGS

DISPLACEMENT				YEAR	GENERAL APPLICATION DATA (ENGINE SERIES/MAKE/MODEL)	CAMSHAFT BEARING SET		
CYL.	CI./CC.	L	BORE			STD.	HI-PERF.	OHC

SPECIALTY AFTERMARKET BLOCKS (Cont.)								
8 cyl	-	-	-	ALL	Merlin Block	CH-12	CHP-12 or CHP-12T (Coated)	
8 cyl	-	-	-	ALL	Rodeck Eng.	RDC-1	RDCP-1 or RDCP-1T (Coated)	

* Denotes (OHC) Repair Bearing, Check "Aluminum Overhead Cam Accessories" Section For Tool Information

** Denotes Auxiliary / Balance Shaft Bearing.

"und" Denotes Undersized ID

BEARING SET CONTENTS

SET NO.	ENGINE MFG. / DESCRIPTION	CONTENTS	POSITION	HOUSING BORE	LENGTH	MAX WALL
351HP	Ford - HP Cam Bearing Set (Stepped Cam)	351HP-1	1	2.2040	0.660	.0602
		351HP-2	2	2.2040	0.660	.0677
		351HP-3	3	2.2040	0.660	.0752
		351HP-4	4	2.2040	0.660	.0827
		351HP-5	5	2.2040	0.660	.0902
351HPT	Ford - HP Cam Bearing Set (Coated), (Stepped Cam)	351HP-1T	1	2.2040	0.660	.0602
		351HP-2T	2	2.2040	0.660	.0677
		351HP-3T	3	2.2040	0.660	.0752
		351HP-4T	4	2.2040	0.660	.0827
		351HP-5T	5	2.2040	0.660	.0902
351HP-R1	Ford - HP Cam Bearing Set w/ .010 Oversize OD (Stepped Cam)	351HP-1R1	1	2.2140	0.660	.0652
		351HP-2R1	2	2.2140	0.660	.0727
		351HP-3R1	3	2.2140	0.660	.0802
		351HP-4R1	4	2.2140	0.660	.0877
		351HP-5R1	5	2.2140	0.660	.0952
351RHP	Ford - HP Cam Bearing Set (2.081" Journals, No.1-5 Position)	351HP-1	1,2,3,4,5	2.2040	0.660	.0602
351RHPT	Ford - HP Cam Bearing Set (Coated) (2.081" Journals, No.1-5 Position)	351HP-1T	1,2,3,4,5	2.2040	0.660	.0602
A-1 .010 und	Allis Chalmers - Cam Bearing Set	A-1-1	1,2,3	1.8805	1.125	.0642
A-2	Allis Chalmers, Le Roi - Cam Bearing Set	A-2-1	1,2,3	2.0055	1.308	.0643
A-3	Allis Chalmers - Cam Bearing Set	A-3-1	1	2.2595	1.385	.0630
		A-3-2	2,3	2.2595	1.000	.0630
A-4	Allis Chalmers - Cam Bearing Set	A-3-1	1	2.2595	1.385	.0630
		A-3-2	2,3,4	2.2595	1.000	.0630
A-5	Allis Chalmers - Cam Bearing Set	A-3-1	1	2.2595	1.385	.0630
		A-3-2	2,3,4,5,6	2.2595	1.000	.0630
A-6	Allis Chalmers - Cam Bearing Set	A-1-1	1,3	1.8805	1.125	.0642
		A-6-1	2	1.8805	1.125	.0642
B-6 .010 und	American Mototrs, General Motors, Jeep - Cam Bearing Set	B-6-1	1	1.8865	0.750	.0642
		B-4-3	2	1.8565	0.750	.0643
		B-4-4	3	1.8265	0.750	.0643
		B-4-5	4	1.7965	0.750	.0643
B-8 .010 und .020 und	General Motors - Cam Bearing Set	B-4-1	1	1.9165	0.750	.0643
		B-6-1	2	1.8865	0.750	.0642
		B-4-3	3	1.8565	0.750	.0643
		B-4-4	4	1.8265	0.750	.0643
		B-4-5	5	1.7965	0.750	.0643
B-9 .010 und .020 und .030 und	General Motors, Jeep - Cam Bearing Set	B-11-1	1	1.9165	0.750	.0642
		B-9-2	2,3,4,5	1.9165	0.620	.0642
B-11 .010 und .020 und	General Motors, MG, Rover, Triumph - Cam Bearing Set	B-11-1	1	1.9165	0.750	.0642
		B-6-1	2	1.8865	0.750	.0642
		B-4-3	3	1.8565	0.750	.0643
		B-4-4	4	1.8265	0.750	.0643
		B-4-5	5	1.7965	0.750	.0643
B-12 .010 und .020 und	General Motors - Cam Bearing Set	B-11-1	1	1.9165	0.750	.0642
		B-9-2	2,3,4	1.9165	0.620	.0642
B-12B .010 und	General Motors - Special Oil Control Cam Bearing Set w/ OD Groove No.1 Position	B-11-1B	1	1.9165	0.750	.0642
		B-9-2	2,3,4	1.9165	0.620	.0642

*Denotes (OHC) Repair Bearing, Check "Aluminum Overhead Cam Accessories" Section For Tool Information

**Denotes Auxiliary / Balance Shaft Bearing

"und" Denotes Undersized ID

BEARING SET CONTENTS

SET NO.	ENGINE MFG. / DESCRIPTION	CONTENTS	POSITION	HOUSING BORE	LENGTH	MAX WALL
B-13 .010 und	General Motors - Cam Bearing Set	B-13-1	1,4	1.9365	0.750	.0743
		B-9-2	2,3	1.9165	0.620	.0642
B-13R	General Motors - Cam Bearing Set w/ .025 Oversize OD	B-13-1R	1,4	1.9625	0.750	.0743
		B-9-2R	2,3	1.9625	0.620	.0642
B-14 .010 und .020 und	General Motors - Cam Bearing Set	B-14-1	1,4	1.9965	0.745	.0741
		B-14-2	2,3	1.9765	0.630	.0641
B-14R	General Motors - Cam Bearing Set w/ .025 Oversize OD	B-14-1R	1,4	2.0207	0.745	.0741
		B-14-2R	2,3	2.0207	0.630	.0641
BL-1	Austin, MG, Morris - Cam Bearing Set	BL-1-1	1	1.7960	1.125	.0644
		BL-1-2	2	1.7539	0.755	.0644
		BL-1-3	3	1.5039	0.533	.0644
BMA-1*	BMW - OHC Cam Bearing Set (Full Round)	BMA-1-1	1	1.8918	0.800	.0403
		BMA-1-2	2	1.8524	0.800	.0403
		BMA-1-3	3	1.8131	0.800	.0403
		BMA-1-4	4	1.4587	1.390	.0403
BMA-2*	BMW - OHC Cam Bearing Set (Full Round)	BMA-1-1	1	1.8918	0.800	.0403
		BMA-1-2	2	1.8524	0.800	.0403
		BMA-1-3	3	1.8131	0.800	.0403
		BMA-1-10	4	1.5772	0.800	.0403
BMA-3*	BMW - OHC Cam Bearing Set (Full Round)	BMA-1-1	1	1.8918	0.800	.0403
		BMA-1-5	2	1.8918	0.800	.0500
		BMA-1-2	3	1.8524	0.800	.0403
		BMA-1-6	4	1.8524	0.995	.0500
		BMA-1-3	5	1.8131	0.800	.0403
		BMA-1-7	6	1.8131	0.800	.0500
		BMA-1-10	7	1.5772	0.800	.0403
BMA-4*	BMW - OHC Cam Bearing Set (Full Round)	BMA-1-8	1	1.7741	1.115	.0403
		BMA-1-9	2	1.7340	1.085	.0400
		BMA-4-3	3	1.4587	1.000	.0398
BP-9	General Motors, Jeep - HP Cam Bearing Set	BP-11-1	1	1.9165	0.750	.0642
		BP-9-2	2,3,4,5	1.9165	0.620	.0642
BP-9T	General Motors, Jeep - HP Cam Bearing Set (Coated)	BP-11-1T	1	1.9165	0.750	.0642
		BP-9-2T	2,3,4,5	1.9165	0.620	.0642
BP-13	General Motors - HP Cam Bearing Set	BP-13-1	1,4	1.9365	0.750	.0743
		BP-9-2	2,3	1.9165	0.620	.0642
BP-13T	General Motors - HP Cam Bearing Set (Coated)	BP-13-1T	1,4	1.9365	0.750	.0743
		BP-9-2T	2,3	1.9165	0.620	.0642
BU-2 .010 und	Allis Chalmers, Buda, Military Standard - Cam Bearing Set	BU-1-1	1	2.1245	1.125	.0615
		BU-1-2	2,3	2.1245	0.875	.0615
		BU-1-3	4	1.3745	1.000	.0615
C-2 .010 und	General Motors - Cam Bearing Set	C-2-1	1,2,3,4	1.8797	0.750	.0641
		C-2-2	5	1.5682	0.875	.0642
C-3 .010 und .020 und .030 und	General Motors - Cam Bearing Set	C-3-1	1,2,3,4,5	1.8797	0.620	.0637
C-4 .010 und .030 und	General Motors - Cam Bearing Set	C-4-1	1	2.1687	0.591	.0652
		C-4-2	2	2.1487	0.591	.0652
		C-4-3	3	2.1287	0.591	.0652
		C-4-4	4	2.1087	0.591	.0652
		C-4-5	5	2.0887	0.591	.0652

*Denotes (OHC) Repair Bearing, Check "Aluminum Overhead Cam Accessories" Section For Tool Information

**Denotes Auxiliary / Balance Shaft Bearing

"und" Denotes Undersized ID

BEARING SET CONTENTS

SET NO.	ENGINE MFG. / DESCRIPTION	CONTENTS	POSITION	HOUSING BORE	LENGTH	MAX WALL
C-4A	General Motors - Cam Bearing Set w/ Wide No. 5 Position	C-4-1	1	2.1687	0.591	.0652
		C-4-2	2	2.1487	0.591	.0652
		C-4-3	3	2.1287	0.591	.0652
		C-4-4	4	2.1087	0.591	.0652
		C-4-5A	5	2.0887	0.685	.0652
CA-3 .010 und	Case Tractor, Continental, Military Standard - Cam Bearing Set	CA-3-1	1	1.8805	1.312	.0642
		CA-3-2	2	1.8805	0.718	.0642
		CA-3-3	3	1.8805	1.187	.0642
CA-4 .010 und	Case Tractor - Cam Bearing Set	CA-4-1	1,3	1.8805	1.218	.0643
		CA-4-2	2	1.8805	0.495	.0642
CA-5	Case Tractor - Cam Bearing Set	CA-4-1	1,5	1.8805	1.218	.0643
		CA-4-2	2,4	1.8805	0.495	.0642
		CA-5-3	3	1.8805	0.718	.0642
CA-6	Case Tractor - Cam Bearing Set	CA-6-1	1	2.3745	1.656	.0625
		CA-6-2	2,3	2.3745	1.437	.0625
		CA-6-3	4	2.3745	1.156	.0625
CA-7	Case Tractor - Cam Bearing Set	CA-6-1	1	2.3745	1.656	.0625
		CA-6-2	2,3,4	2.3745	1.437	.0625
		CA-6-3	5	2.3745	1.156	.0625
CA-8	Case Tractor - Cam Bearing Set	CA-4-1	1,3	1.8805	1.218	.0643
		CA-4-2	2,4	1.8805	0.495	.0642
CA-9	Case Tractor - Cam Bearing Set	CA-4-1	1	1.8805	1.218	.0643
		CA-4-2	2,3,4	1.8805	0.495	.0642
		CA-9-1	5	1.8805	0.970	.0640
CAT-2	Caterpillar, Ford, General Motors, IHC, Oliver Tractor - Cam Bearing Set	CAT-1-2	1,2,3,4,5	2.6525	0.755	.0750
CAT-2-1	Caterpillar, Ford - Multi-Engine Application (Bearings Sold Separately)	CAT-2-1		2.5630	1.125	.1243
CAT-2-2	Caterpillar, Ford - Multi-Engine Application (Bearings Sold Separately)	CAT-2-2		2.5630	1.004	.1243
CAT-2-3	Caterpillar - Multi-Engine Application (Bearings Sold Separately)	CAT-2-3		2.2776	1.185	.0946
CAT-2-4	Caterpillar - Multi-Engine Application (Bearings Sold Separately)	CAT-2-4		2.2776	2.000	.0946
CAT-2-5	Caterpillar, Ford - Multi-Engine Application (Bearings Sold Separately)	CAT-2-5		2.1880	1.180	.1052
CAT-2-6	Caterpillar, Ford - Multi-Engine Application (Bearings Sold Separately)	CAT-2-6		2.1880	2.000	.1052
CAT-3-1	Caterpillar - Multi-Engine Application (Bearings Sold Separately)	CAT-3-1		2.8745	1.185	.1258
CAT-3-2	Caterpillar - Multi-Engine Application (Bearings Sold Separately)	CAT-3-2		2.8745	1.995	.1256
CAT-5	Caterpillar - Cam Bearing Set	CAT-5-0	1	2.7559	1.340	.0945
		CAT-5-1	2,3,4,5,6,7	2.7165	0.750	.0748
CAT-6	Caterpillar - Cam Bearing Set	CAT-2-1	1	2.5630	1.125	.1243
		CAT-2-2	2,3,4,5	2.5630	1.004	.1243
CAT-7**	Caterpillar - Balance Shaft Bearing Set	CAT-2-1	Center	2.5630	1.125	.1243
		CAT-2-2	Front, Rear	2.5630	1.004	.1243
CAT-8	Caterpillar - Cam Bearing Set	CAT-5-0	1	2.7559	1.340	.0945
		CAT-5-1	2,3,4,5	2.7165	0.750	.0748
CH-2 .010 und .020 und .030 und	General Motors, Military Standard - Cam Bearing Set	CH-2-1	1	2.1599	1.125	.0644
		CH-2-2	2	2.0975	0.937	.0644
		CH-2-3	3	2.0350	0.937	.0644
		CH-2-4	4	1.9725	0.937	.0644

*Denotes (OHC) Repair Bearing, Check "Aluminum Overhead Cam Accessories" Section For Tool Information

**Denotes Auxiliary / Balance Shaft Bearing

"und" Denotes Undersized ID

BEARING SET CONTENTS

SET NO.	ENGINE MFG. / DESCRIPTION	CONTENTS	POSITION	HOUSING BORE	LENGTH	MAX WALL
CH-3 .010 und .020 und .030 und	General Motors - Cam Bearing Set	CH-3-1	1	2.2850	1.125	.0641
		CH-3-2	2	2.2225	0.937	.0641
		CH-3-3	3	2.1600	0.937	.0641
		CH-3-4	4	2.0975	0.937	.0642
CH-4 .010 und .020 und .030 und	General Motors - Cam Bearing Set	CH-4-1	1	2.0200	0.740	.0744
		CH-4-2	2	2.0100	0.740	.0694
		CH-4-3	3,4	2.0000	0.740	.0644
		CH-4-4	5	2.0100	0.940	.0694
CH-4A	General Motors - Cam Bearing Set w/ .010 Oversize OD	CH-4-1S	1,2,3,4,5	2.0300	0.740	.0795
CH-5	General Motors - Cam Bearing Set	CH-5-1	1	2.0200	0.860	.0744
		CH-5-2	2	2.0100	0.860	.0694
		CH-5-3	3,4	2.0000	0.860	.0644
		CH-5-4	5	2.0100	0.940	.0694
CH-6 .010 und	Chevrolet Marine, General Motors - Cam Bearing Set	CH-5-2	3	2.0100	0.860	.0694
		CH-5-3	1,2	2.0000	0.860	.0644
CH-7 .010 und .020 und .030 und	Checker, General Motors, Studebaker - Cam Bearing Set	CH-5-2	1,4	2.0100	0.860	.0694
		CH-5-3	2,3	2.0000	0.860	.0644
CH-8 .010 und .020 und .030 und	Checker, General Motors, Isuzu, Military Standard, Studebaker, Volvo-Penta - Cam Bearing Set	CH-4-1	1	2.0200	0.740	.0744
		CH-4-2	2,5	2.0100	0.740	.0694
		CH-4-3	3,4	2.0000	0.740	.0644
CH-8W	General Motors - Cam Bearing Set w/ .001 Under ID	CH-4-1W	1	2.0200	0.740	.0749
		CH-4-2W	2,5	2.0100	0.740	.0699
		CH-4-3W	3,4	2.0000	0.740	.0649
CH-9A .010 und	General Motors - Cam Bearing Set (Bearing Set Requires Cam to Be Grooved)	CH-12-1	1	2.1400	0.860	.0941
		CH-12-2	2	2.1300	0.980	.0891
		CH-12-3	3,4	2.1200	0.980	.0841
		CH-9-4	5	2.1300	0.980	.0894
CH-10 .010 und .020 und	General Motors - Cam Bearing Set	CH-10-1	1,5	2.3270	0.630	.0790
		CH-10-2	2,4	2.3171	0.630	.0740
		CH-10-3	3	2.3088	0.630	.0700
CH-11 .010 und .020 und .030 und	Checker, General Motors - Cam Bearing Set	CH-5-3	1,2,3,4	2.0000	0.860	.0644
CH-11B	Checker, General Motors - Special Oil Control Cam Bearing Set w/ OD Groove	CH-5-3B	1,2,3,4	2.0000	0.860	.0644
CH-12 .010 und .020 und .030 und	General Motors - Cam Bearing Set	CH-12-1	1	2.1400	0.860	.0941
		CH-12-2	2,5	2.1300	0.980	.0891
		CH-12-3	3,4	2.1200	0.980	.0841
CH-12B	General Motors - Special Oil Control Cam Bearing Set w/ OD Groove	CH-12-1B	1	2.1400	0.860	.0941
		CH-12-2B	2,5	2.1300	0.980	.0891
		CH-12-3B	3,4	2.1200	0.980	.0841
CH-13 .010 und	General Motors - Cam Bearing Set	CH-13-1	1	2.4125	0.680	.0643
		CH-13-2	2,3,4,5	2.4125	0.680	.0643
CH-16 .010 und .020 und	American Motors, General Motors, Jeep - Cam Bearing Set	CH-5-3	1,2,3	2.0000	0.860	.0644
CH-16W	American Motors, General Motors, Jeep - Cam Bearing Set w/ .001 Under ID	CH-5-3W	1,2,3	2.0000	0.860	.0649

*Denotes (OHC) Repair Bearing, Check "Aluminum Overhead Cam Accessories" Section For Tool Information

**Denotes Auxiliary / Balance Shaft Bearing

"und" Denotes Undersized ID

BEARING SET CONTENTS

SET NO.	ENGINE MFG. / DESCRIPTION	CONTENTS	POSITION	HOUSING BORE	LENGTH	MAX WALL
CH-17 .010 und .020 und	Checker, General Motors, Isuzu - Cam Bearing Set	CH-4-1	1	2.0200	0.740	.0744
		CH-4-2	2,4	2.0100	0.740	.0694
		CH-4-3	3	2.0000	0.740	.0644
CH-17X	Checker, General Motors, Isuzu - Cam Bearing Set w/ .001 Under ID	CH-4-1W	1	2.0200	0.740	.0749
		CH-4-2W	2,4	2.0100	0.740	.0699
		CH-4-3W	3	2.0000	0.740	.0649
CH-17G	General Motors, Isuzu - Cam Bearing & Balance Shaft Bearing Kit (Combines CH-17 & CHG-15A**)	CH-4-1	1	2.0200	0.740	.0744
		CH-4-2	2,4	2.0100	0.740	.0694
		CH-4-3	3	2.0000	0.740	.0644
		CHG-15-1	1	1.8740	0.835	.1860
		SH-1798T	(Tool)			
CH-18 .010 und .020 und	General Motors, Isuzu, Jeep - Cam Bearing Set	CH-18-1A	1	2.0100	0.625	.0691
		CH-18-2	2,3	1.9995	0.630	.0640
		CH-18-4	4	2.0095	0.625	.0691
CH-18A .010 und	General Motors, Isuzu, Jeep - Cam Bearing Set w/ Wide No. 2, 3 Position	CH-18-1A	1	2.0100	0.625	.0691
		CH-18-2A	2,3	1.9995	0.720	.0640
		CH-18-4	4	2.0095	0.625	.0691
CH-18R8	General Motors, Isuzu, Jeep - Cam Bearing Set w/ Oversize OD	CH-18-1R8	1	2.0900	0.625	.1091
		CH-18-2R8	2,3	2.0800	0.720	.1040
		CH-18-4R8	4	2.0900	0.625	.1091
CH-18RS	General Motors, Isuzu, Jeep - Cam Bearing Set w/ Oversize OD	CH-18-1R3	1	2.0400	0.625	.0848
		CH-18-2R2	2,3	2.0300	0.720	.0798
		CH-18-4R4	4	2.0400	0.625	.0847
CH-19 .010 und	General Motors, Isuzu - Cam Bearing Set	CH-19-1	1	2.0199	0.625	.0741
		CH-18-4	2,5	2.0095	0.625	.0691
		CH-18-2	3,4	1.9995	0.630	.0640
CH-19X2	General Motors, Isuzu - Cam Bearing Set w/ .002 Under ID	CH-19-1X2	1	2.0199	0.625	.0751
		CH-18-4X2	2,5	2.0095	0.625	.0701
		CH-18-2X2	3,4	1.9995	0.630	.0650
CH-20	General Motors - Cam Bearing Set	CH-20-1	1,2,3	2.0000	0.710	.0644
CH-21 .010 und .020 und	General Motors, Isuzu - Cam Bearing Set	CH-4-1	1,4	2.0200	0.740	.0744
		CH-4-2	3	2.0100	0.740	.0694
		CH-4-3	2	2.0000	0.740	.0644
CH-21G	General Motors, Isuzu - Cam Bearing & Balance Shaft Bearing Kit (Combines CH-21 & CHG-15A**)	CH-4-1	1,4	2.0200	0.740	.0744
		CH-4-2	3	2.0100	0.740	.0694
		CH-4-3	2	2.0000	0.740	.0644
		CHG-15-1	1	1.8740	0.835	.1860
		SH-1798T	(Tool)			
CH-21X	General Motors, Isuzu - Cam Bearing Set w/ .001 Under ID	CH-4-1W	1,4	2.0200	0.740	.0749
		CH-4-2W	3	2.0100	0.740	.0699
		CH-4-3W	2	2.0000	0.740	.0649
CH-23 .010 und .020 und	General Motors - Cam Bearing Set	CH-10-1	2,4	2.3270	0.630	.0790
		CH-23-1	1,5	2.3470	0.630	.0890
		CH-10-3	3	2.3088	0.630	.0700
CH-24	General Motors - Cam Bearing Set	CH-24-1	1	2.1766	0.905	.0747
		CH-24-2	2,3	2.1565	0.630	.0646
		CH-24-3	4	2.1766	0.620	.0747
CH-25 .030 und	General Motors - Cam Bearing Set	CH-25-1	1,5	2.3482	0.775	.0890
		CH-25-2	2,4	2.3285	0.775	.0799
		CH-25-3	3	2.3088	0.775	.0700
CHG-14**	General Motors, Isuzu, Opel - Balance Shaft Bearing Set	AGB-14-1	1,2,3	1.8895	0.984	.0586
CHG-15A**	General Motors, Isuzu - Balance Shaft Bearing Set (Rear Bearing)	CHG-15-1	1	1.8740	0.835	.1860
		SH-1798T	(Tool)			

*Denotes (OHC) Repair Bearing, Check "Aluminum Overhead Cam Accessories" Section For Tool Information

**Denotes Auxiliary / Balance Shaft Bearing

"und" Denotes Undersized ID

BEARING SET CONTENTS

SET NO.	ENGINE MFG. / DESCRIPTION	CONTENTS	POSITION	HOUSING BORE	LENGTH	MAX WALL
CHG-22**	General Motors - Auxiliary Shaft Bearing Set	CHG-22-1	1	2.0100	1.172	.0691
		CH-18-2	2,3	1.9995	0.630	.0640
		CH-18-4	4	2.0095	0.625	.0691
CHG-23**	General Motors - Balance Shaft Bearing Set	CHG-23-1	Right Rear	1.6253	0.865	.0808
		CHG-23-2	Right Front	1.5969	0.865	.0808
		CHG-23-3	Left Front	1.8672	0.862	.0808
		CHG-23-4	Left Rear	1.8955	0.862	.0808
CHG-24**	General Motors - Balance Shaft Bearing Set	CHG-24-1	1,2 (2 pcs.)	1.6050	1.020	.0786
CHP-4	General Motors - HP Cam Bearing Set	CHP-4-1	1	2.0200	0.740	.0744
		CHP-4-2	2	2.0100	0.740	.0694
		CHP-4-3	3,4	2.0000	0.740	.0644
		CHP-4-4	5	2.0100	0.940	.0694
CHP-4T	General Motors - HP Cam Bearing Set (Coated)	CHP-4-1T	1	2.0200	0.740	.0744
		CHP-4-2T	2	2.0100	0.740	.0694
		CHP-4-3T	3,4	2.0000	0.740	.0644
		CHP-4-4T	5	2.0100	0.940	.0694
CHP-8	Checker, General Motors, Isuzu, Military Standard, Studebaker, Volvo-Penta - HP Cam Bearing Set	CHP-4-1	1	2.0200	0.740	.0744
		CHP-4-2	2,5	2.0100	0.740	.0694
		CHP-4-3	3,4	2.0000	0.740	.0644
CHP-8T	Checker, General Motors, Isuzu, Military Standard, Studebaker, Volvo-Penta - HP Cam Bearing Set (Coated)	CHP-4-1T	1	2.0200	0.740	.0744
		CHP-4-2T	2,5	2.0100	0.740	.0694
		CHP-4-3T	3,4	2.0000	0.740	.0644
CHP-8R1	General Motors - HP Cam Bearing Set w/ .010 Oversize OD	CHP-4-11	1,2,3,4,5	2.0300	0.740	.0794
CHP-8R1T	General Motors - HP Cam Bearing Set (Coated) w/ .010 Oversize OD	CHP-4-11T	1,2,3,4,5	2.0300	0.740	.0794
CHP-8R2	General Motors - HP Cam Bearing Set w/ .020 Oversize OD	CHP-4-12	1,2,3,4,5	2.0400	0.740	.0844
CHP-8R2T	General Motors - HP Cam Bearing Set (Coated) w/ .020 Oversize OD	CHP-4-12T	1,2,3,4,5	2.0400	0.740	.0844
CHP-8R3	General Motors - HP Cam Bearing Set w/ .030 Oversize OD	CHP-4-13	1,2,3,4,5	2.0500	0.740	.0894
CHP-8R3T	General Motors - HP Cam Bearing Set (Coated) w/ .030 Oversize OD	CHP-4-13T	1,2,3,4,5	2.0500	0.740	.0894
CHP-8R4	General Motors - HP Cam Bearing Set w/ .040 Oversize OD	CHP-4-14	1,2,3,4,5	2.0600	0.740	.0944
CHP-8R4T	General Motors - HP Cam Bearing Set (Coated) w/ .040 Oversize OD	CHP-4-14T	1,2,3,4,5	2.0600	0.740	.0944
CHP-10	General Motors - HP Cam Bearing Set	CHP-10-1	1,5	2.3270	0.630	.0790
		CHP-10-2	2,4	2.3171	0.630	.0740
		CHP-10-3	3	2.3088	0.630	.0700
CHP-10T	General Motors - HP Cam Bearing Set (Coated)	CHP-10-1T	1,5	2.3270	0.630	.0790
		CHP-10-2T	2,4	2.3171	0.630	.0740
		CHP-10-3T	3	2.3088	0.630	.0700
CHP-12	General Motors - HP Cam Bearing Set	CHP-12-1	1	2.1400	0.860	.0941
		CHP-12-2	2,5	2.1300	0.980	.0891
		CHP-12-3	3,4	2.1200	0.980	.0841
CHP-12T	General Motors - HP Cam Bearing Set (Coated)	CHP-12-1T	1	2.1400	0.860	.0941
		CHP-12-2T	2,5	2.1300	0.980	.0891
		CHP-12-3T	3,4	2.1200	0.980	.0841
CHP-12R1	General Motors - HP Cam Bearing Set w/ .010 Oversize OD	CHP-12-11	1	2.1500	0.860	.0991
		CHP-12-21	2,3,4,5	2.1500	0.980	.0991
CHP-12R2	General Motors - HP Cam Bearing Set w/ .020 Oversize OD	CHP-12-12	1	2.1600	0.860	.1041
		CHP-12-22	2,3,4,5	2.1600	0.980	.1041

*Denotes (OHC) Repair Bearing, Check "Aluminum Overhead Cam Accessories" Section For Tool Information

**Denotes Auxiliary / Balance Shaft Bearing

"und" Denotes Undersized ID

BEARING SET CONTENTS

SET NO.	ENGINE MFG. / DESCRIPTION	CONTENTS	POSITION	HOUSING BORE	LENGTH	MAX WALL
CHP-17	Checker, General Motors, Isuzu - HP Cam Bearing Set	CHP-4-1	1	2.0200	0.740	.0744
		CHP-4-2	2,4	2.0100	0.740	.0694
		CHP-4-3	3	2.0000	0.740	.0644
CHP-17T	General Motors, Isuzu - HP Cam Bearing Set (Coated)	CHP-4-1T	1	2.0200	0.740	.0744
		CHP-4-2T	2,4	2.0100	0.740	.0694
		CHP-4-3T	3	2.0000	0.740	.0644
CHP-21	General Motors, Isuzu - HP Cam Bearing Set	CHP-4-1	1,4	2.0200	0.740	.0744
		CHP-4-2	3	2.0100	0.740	.0694
		CHP-4-3	2	2.0000	0.740	.0644
CHP-21T	General Motors, Isuzu - HP Cam Bearing Set (Coated)	CHP-4-1T	1,4	2.0200	0.740	.0744
		CHP-4-2T	3	2.0100	0.740	.0694
		CHP-4-3T	2	2.0000	0.740	.0644
CHP-23	General Motors - HP Cam Bearing Set	CHP-10-1	2,4	2.3270	0.630	.0790
		CHP-23-1	1,5	2.3470	0.630	.0890
		CHP-10-3	3	2.3088	0.630	.0700
CHP-23T	General Motors - HP Cam Bearing Set	CHP-10-1T	2,4	2.3270	0.630	.0790
		CHP-23-1T	1,5	2.3470	0.630	.0890
		CHP-10-3T	3	2.3088	0.630	.0700
CHP-25	General Motors - HP Cam Bearing Set	CHP-25-1	1,5	2.3482	0.775	.0890
		CHP-25-2	2,4	2.3285	0.775	.0799
		CHP-25-3	3	2.3088	0.775	.0700
CHP-25T	General Motors - HP Cam Bearing Set	CHP-25-1T	1,5	2.3482	0.775	.0890
		CHP-25-2T	2,4	2.3285	0.775	.0799
		CHP-25-3T	3	2.3088	0.775	.0700
CO-3 .010 und .020 und .030 und	Continental, IHC, Jeep, Oliver Tractor - Cam Bearing Set	K-1-2	1	1.9375	0.937	.0630
		K-1-3	2	1.8750	1.620	.0628
		K-1-4	3	1.3748	1.156	.0628
CO-7	Continental, Mack - Cam Bearing Set	CO-7-1	1	2.3743	1.094	.0940
		CO-7-2	2	2.3120	1.000	.0940
		CO-7-3	3	2.2495	1.000	.0940
		CO-7-4	4	1.9370	1.250	.0940
CO-8 .010 und .020 und .030 und	Continental, John Deere, Mack, Military Standard, Oliver Tractor - Cam Bearing Set	K-1-1	1	2.0000	0.875	.0628
		K-1-3	2	1.8810	1.620	.0628
		K-1-4	3	1.3748	1.156	.0628
CO-9	Continental, IHC - Cam Bearing Set	CO-9-1	1	1.9375	1.323	.0626
		CO-9-2	2	1.8750	0.573	.0626
		CO-9-3	3	1.8125	1.135	.0626
CU-5A	Cummins, Ford, General Motors, IHC, Komatsu - Cam Bearing Set	CU-1-1	1	2.1290	2.250	.0644
		CU-5-2A	2,3,4,5,6,7	2.1250	1.685	.0644
CU-9	Cummins, Ford, General Motors, IHC - Cam Bearing Set	CU-9-1	1,2,4,6	2.6870	1.685	.0939
		CU-9-2	3,5	2.6870	2.185	.0939
		CU-8-1	7	2.6870	1.685	.0939
CU-10	Cummins - Cam Bearing Set	CU-1-1	1	2.1290	2.250	.0644
		CU-5-2A	2,3,4,5	2.1250	1.685	.0644
CU-11	Cummins, Ford - Cam Bearing Set	CU-11-1	1,5	2.1870	1.905	.0932
		CU-11-2	2,3,4	2.1870	0.905	.0932
CU-11A	Cummins - Cam Bearing Set	CU-11-1	1,4	2.1870	1.905	.0932
		CU-11-2	2,3	2.1870	0.905	.0932
CU-12	Case Tractor, Chrysler, Cummins, Ford - Cam Bearing Set	CU-12-1	1	2.2535	1.005	.0620
CU-13	Cummins - Cam Bearing Set	CU-13-1	1,5	2.6870	1.810	.0937
		CU-13-2	2,3,4	2.6870	1.070	.0937

*Denotes (OHC) Repair Bearing, Check "Aluminum Overhead Cam Accessories" Section For Tool Information

**Denotes Auxiliary / Balance Shaft Bearing

"und" Denotes Undersized ID

BEARING SET CONTENTS

SET NO.	ENGINE MFG. / DESCRIPTION	CONTENTS	POSITION	HOUSING BORE	LENGTH	MAX WALL
CU-14	Chrysler, Cummins - Cam Bearing Set	CU-14-1	1	2.3323	1.005	.1010
DA-1	Nissan - Cam Bearing Set	DA-1-1	1	1.8509	0.930	.0625
		DA-1-2	2	1.8312	0.555	.0625
		DA-1-3	3	1.8115	0.555	.0625
		DA-1-4	4	1.7918	0.555	.0625
		DA-1-5	5	1.7495	0.555	.0625
DA-2 .010 und .020 und	Astin, Audi, IHC, Metropolitan-Nash, MG, Morris, Nissan, Nuffield Tractor, Riley - Cam Bearing Set	DA-2-1	1	1.9155	1.455	.0624
		DA-2-2	2	1.8555	1.070	.0624
		DA-2-3	3	1.7495	0.812	.0624
DA-3A	Nissan - Cam Bearing Set	DA-3-1	1	1.9155	0.945	.0625
		DA-3-2	2	1.8555	0.865	.0625
		DA-3-3A	3	1.7495	0.947	.0625
DA-5	IHC, Nissan - Cam Bearing Set	DA-3-1	1	1.9155	0.945	.0625
		DA-3-2	2,3	1.8555	0.865	.0625
		DA-3-3A	4	1.7495	0.947	.0625
DE-1	Detroit Diesel - Cam Bearing & Balance Shaft Bearing Set	DE-1-1	1,2,3,4,5	2.2505	1.545	.0925
DE-2	Detroit Diesel - Cam Bearing & Balance Shaft Bearing Set	DE-2-1	1,3 (4 pcs.)	2.3755	1.505	.0943
		DE-2-2	2 (1 pcs.)	2.3655	1.505	.0900
DE-2A	Detroit Diesel, Military Standard - Cam Bearing & Balance Shaft Bearing Set	DE-2-1	1,3 (4 pcs.)	2.3755	1.505	.0943
		DE-2-2	2 (2 pcs.)	2.3655	1.505	.0900
DE-2R1	Detroit Diesel - Cam Bearing & Balance Shaft Bearing Set w/ .010 Oversize OD	DE-2-1R1	1,3 (4 pcs.)	2.3855	1.505	.0993
		DE-2-2R1	2 (1 pcs.)	2.3755	1.505	.0943
DE-2AR1	Detroit Diesel, Military Standard - Cam Bearing & Balance Shaft Bearing Set w/ .010 Oversize OD	DE-2-1R1	1,3 (4 pcs.)	2.3855	1.505	.0993
		DE-2-2R1	2 (2 pcs.)	2.3755	1.505	.0943
DE-4	Detroit Diesel, Ford - Cam Bearing Set	DE-4-1	1,2,3,4,5	2.7216	0.705	.0774
DE-5	Detroit Diesel - Cam Bearing & Balance Shaft Bearing Set	DE-2-1	1,4	2.3755	1.505	.0943
		DE-2-2	2,3	2.3655	1.505	.0900
DE-5R1	Detroit Diesel - Cam Bearing & Balance Shaft Bearing Set w/ .010 Oversize OD	DE-2-1R1	1,4	2.3855	1.505	.0993
		DE-2-2R1	2,3	2.3755	1.505	.0943
DE-7	Detroit Diesel - Cam Bearing & Balance Shaft Bearing Set	DE-2-1	1,5 (4 pcs.)	2.3755	1.505	.0943
		DE-2-2	2,4 (2 pcs.)	2.3655	1.505	.0900
		DE-2-3	3 (1 pcs.)	2.3555	1.505	.0844
DT-1	Specialty Aftermarket Blocks - HP Cam Bearing Set (OD Groove w/ 3 Hole, 120 Degree Spacing)	DT-1-1	1,2,3,4,5	2.0000	0.740	.0644
DT-1T	Specialty Aftermarket Blocks - HP Cam Bearing Set (Coated), (OD Groove w/ 3 Hole, 120 Degree Spacing)	DT-1-1T	1,2,3,4,5	2.0000	0.740	.0644
DT-1TR1	Specialty Aftermarket Blocks - HP Cam Bearing Set (Coated) w/ .010 Oversize OD (OD Groove w/ 3 Hole, 120 Degree Spacing)	DT-1-11T	1,2,3,4,5	2.0100	0.740	.0694
F-1 .010 und .020 und .030 und	Ford, Military Standard - Cam Bearing Set	F-1-1	1,3	1.9280	1.600	.0648
		F-1-2	2	1.9280	1.312	.0648
F-7 .010 und .020 und .030 und	Ford - Cam Bearing Set	F-22-1	1,2,4	2.0580	0.875	.0649
		F-7-2	3	2.0580	0.875	.0649
F-9A .010 und .020 und .030 und	Ford - Cam Bearing Set (Cams w/ Grooved No. 3 Journal)	F-9-1	1	2.0580	0.875	.0648
		F-9-3	2,3,4,5	2.0580	0.620	.0648

*Denotes (OHC) Repair Bearing, Check "Aluminum Overhead Cam Accessories" Section For Tool Information

**Denotes Auxiliary / Balance Shaft Bearing

"und" Denotes Undersized ID

BEARING SET CONTENTS

SET NO.	ENGINE MFG. / DESCRIPTION	CONTENTS	POSITION	HOUSING BORE	LENGTH	MAX WALL
F-9B .010 und .020 und .030 und	Ford - Cam Bearing Set (Cams w/ Cross-Drilled No.3 Journal)	F-9-1	1	2.0580	0.875	.0648
		F-9-2B	2,3,4,5	2.0580	0.620	.0648
F-11 .020 und .030 und	Ford - Cam Bearing Set	F-8-1	1,5	2.2500	0.875	.0618
		F-11-2	2,3,4	2.2500	0.755	.0618
F-12 .010 und	Ford - Cam Bearing Set	F-12-1	1	2.6000	0.755	.0617
		F-11-2	2,3,4	2.2500	0.755	.0618
		F-8-1	5	2.2500	0.875	.0618
F-16 .010 und	Ford, Military Standard - Cam Bearing Set	F-16-1	1	2.6025	0.670	.0629
		F-16-2	2,3,4,5	2.4985	0.670	.0629
F-18 .010 und .020 und .030 und	Ford - Cam Bearing Set	F-18-1	1	2.2040	0.660	.0602
		F-18-2	2	2.1890	0.660	.0602
		F-18-3	3	2.1740	0.660	.0602
		F-18-4	4	2.1590	0.660	.0602
		F-18-5	5	2.1440	0.660	.0602
F-19 .020 und .030 und	Ford - Cam Bearing Set	F-19-1	1	2.4480	0.710	.0609
		F-19-2	2	2.4330	0.710	.0609
		F-19-3	3	2.4180	0.710	.0609
		F-19-4	4	2.4030	0.710	.0609
		F-14-5	5	2.3880	0.710	.0610
F-22 .010 und .020 und .030 und	Ford - Cam Bearing Set	F-22-1	1,2,3,4	2.0580	0.875	.0649
F-23A .010 und .020 und .030 und	Ford - Cam Bearing Set	F-23-1A	1,2,3,4	2.1445	0.860	.0624
F-23B .010 und	Ford - Special Oil Control Cam Bearing Set w/ OD Groove	F-23-1B	1,2,3,4	2.1445	0.860	.0624
F-24	Ford - Cam Bearing Set	F-33-1	1	2.3100	0.620	.0912
		F-24-2	2	2.2950	0.620	.0844
		F-24-3	3	2.2800	0.620	.0769
		F-24-4	4	2.2650	0.620	.0694
		F-24-5	5	2.2500	0.560	.0619
F-25	Jeep, Military Standard - Cam Bearing Set	F-25-1	1,2,3	2.1365	1.000	.0624
F-26 .010 und .020 und .030 und	Ford - Cam Bearing Set	F-26-1	1	2.2500	0.660	.0616
		F-18-2	2	2.1890	0.660	.0602
		F-18-3	3	2.1740	0.660	.0602
		F-18-4	4	2.1590	0.660	.0602
		F-18-5	5	2.1440	0.660	.0602
F-28 .010 und .020 und	Ford - Cam Bearing Set	F-28-1	1	1.6890	0.790	.0633
		F-28-2	2	1.6890	0.685	.0633
		F-28-3	3	1.6890	0.790	.0633
F-29 .020 und	Ford - Cam Bearing Set	F-29-1	1	1.7755	0.785	.0600
		F-29-2	2	1.8785	0.665	.0600
		F-29-3A	3	1.8935	0.625	.0600
F-30 .010 und .020 und .030 und	Ford - Cam Bearing Set	F-30-1	1,2,3,4,5	2.2500	0.580	.0618

*Denotes (OHC) Repair Bearing, Check "Aluminum Overhead Cam Accessories" Section For Tool Information

**Denotes Auxiliary / Balance Shaft Bearing

"und" Denotes Undersized ID

BEARING SET CONTENTS

SET NO.	ENGINE MFG. / DESCRIPTION	CONTENTS	POSITION	HOUSING BORE	LENGTH	MAX WALL
F-30R1	Ford - Cam Bearing Set w/ .010 Oversize OD	F-30-1R1	1,2,3,4,5	2.2600	0.580	.0668
F-30R2	Ford - Cam Bearing Set w/ .020 Oversize OD	F-30-1R2	1,2,3,4,5	2.2700	0.580	.0718
F-31 .010 und	Ford - Cam Bearing Set	F-31-1 F-31-2 F-31-3 F-31-4	1 2 3 4	1.7734 1.7585 1.7435 1.7285	0.775 0.700 0.700 0.595	.0604 .0604 .0604 .0604
F-32 .010 und .020 und .030 und	Ford - Cam Bearing Set	F-32-1 F-17-2 F-17-3 F-17-4	1 2 3 4	1.9785 1.9635 1.9485 1.9335	0.720 0.720 0.720 0.720	.0832 .0757 .0682 .0607
F-33 .010 und .020 und .030 und	Ford - Cam Bearing Set	F-33-1 F-15-2 F-15-3 F-15-4 F-15-5	1 2 3 4 5	2.3100 2.2950 2.2800 2.2650 2.2500	0.620 0.620 0.620 0.620 0.560	.0912 .0841 .0766 .0691 .0616
F-34 .010 und .030 und	Ford, Mazda - Cam Bearing Set	F-34-1	1,2,3,4	1.9011	0.693	.0638
F-34B .010 und	Ford - Special Oil Control Cam Bearing Set w/ OD Groove	F-34-1B	1,2,3,4	1.9011	0.693	.0638
F-34S	Ford, Mazda - Cam Bearing Set w/ .020 Oversize OD	F-34-1S	1,2,3,4	1.9203	0.693	.0738
F-38	Ford - Cam Bearing & Auxiliary Shaft Bearing Kit (Combines F-52 & FG-51**)	AGB-51-1 F-52-1 F-51-2	1,2 1,4 2,3	2.1920 2.1920 2.1770	0.635 0.635 0.555	.0694 .0694 .0619
F-38X	Ford - Cam Bearing & Auxiliary Shaft Bearing Kit w/ Special Wide No. 2, 3 Position (Combines F-52X & FG-51**)	AGB-51-1 F-52-1X F-51-2X	1,2 1,4 2,3	2.1920 2.1920 2.1770	0.635 0.635 0.595	.0694 .0688 .0613
F-41*	Ford, Mazda - OHC Cam Bearing Set (Half Shell)	F-41-1 F-41-2	1 2,3	1.9299 1.9299	0.949 0.714	.0794 .0794
F-42	Ford, Saab - Cam Bearing Set	F-42-1 F-42-2 F-31-4	1 2 3	1.7585 1.7435 1.7285	0.775 0.700 0.595	.0604 .0604 .0604
F-43	Ford - Cam Bearing Set	F-43-1	1,2,3,4	2.5345	0.765	.0708
F-44	Ford - Cam Bearing Set	F-43-1	1,2,3,4,5	2.5345	0.765	.0708
F-45 .010 und	Ford - Cam Bearing Set	F-45-1 F-45-2	1,4 2,3	2.1920 2.1770	0.635 0.555	.0694 .0619
F-46 .010 und	Ford - Cam Bearing Set	F-46-1 F-46-2 F-46-3	1 2,3 4	2.2047 2.1890 2.2047	0.723 0.723 0.503	.0973 .0894 .0973
F-47 .010 und	Ford - Cam Bearing Set	F-47-1 F-47-2 F-47-3 F-47-4	1 2 3 4	1.8521 1.8371 1.8222 1.8072	0.780 0.700 0.700 0.595	.0605 .0605 .0605 .0605
F-47B .010 und	Ford - Special Oil Control Cam Bearing Set w/ OD Groove No. 2,3 Position	F-47-1 F-47-2B F-47-3B F-47-4	1 2 3 4	1.8521 1.8371 1.8222 1.8072	0.780 0.700 0.700 0.595	.0605 .0605 .0605 .0605
F-48 .010 und .030 und	Ford, Mazda - Cam Bearing Set	F-48-1 F-48-2 F-48-4	1 2,3 4	2.1536 2.1339 2.1536	0.955 0.537 0.537	.0719 .0620 .0719

*Denotes (OHC) Repair Bearing, Check "Aluminum Overhead Cam Accessories" Section For Tool Information

**Denotes Auxiliary / Balance Shaft Bearing

"und" Denotes Undersized ID

BEARING SET CONTENTS

SET NO.	ENGINE MFG. / DESCRIPTION	CONTENTS	POSITION	HOUSING BORE	LENGTH	MAX WALL
F-48A .010 und	Ford - Cam Bearing Set w/ ID Groove No. 4 Position	F-48-1	1	2.1536	0.955	.0719
		F-48-2	2,3	2.1339	0.537	.0620
		F-48-4A	4	2.1536	0.537	.0719
F-49 .010 und	Ford - Cam Bearing Set	F-49-1	1,4	2.1590	0.860	.0695
		F-49-2	2,3	2.1445	0.860	.0624
F-49B .010 und	Ford - Special Oil Control Cam Bearing Set w/ OD Groove	F-49-1B	1,4	2.1590	0.860	.0695
		F-23-1B	2,3	2.1445	0.860	.0624
F-50 .010 und	Ford, Mazda - Cam Bearing Set	F-50-1	1	2.0776	0.775	.0617
		F-50-2	2	2.0626	0.700	.0614
		F-50-3	3	2.0476	0.700	.0614
		F-50-4	4	2.0327	0.585	.0615
F-50A .010 und .020 und .030 und	Ford, Mazda - Cam Bearing Set w/ Special Wide No. 4 Position	F-50-1	1	2.0776	0.775	.0617
		F-50-2	2	2.0626	0.700	.0614
		F-50-3	3	2.0476	0.700	.0614
		F-50-4A	4	2.0327	0.825	.0615
F-52 .010 und	Ford - Cam Bearing Set	F-52-1	1,4	2.1920	0.635	.0694
		F-51-2	2,3	2.1770	0.555	.0619
F-55	Ford - Cam Bearing Set	F-43-1	1,2,3,4,5,6,7	2.5345	0.765	.0708
F-57	Ford - Cam Bearing Set	F-30-1S	1,2,3,4,5	2.2650	0.625	.0694
FA-1*	Ford - OHC Cam Bearing Set (Full Round)	FA-1-1	1	1.9035	0.925	.0503
		FA-1-2	2	1.8985	0.925	.0478
		FA-1-3	3	1.8935	0.925	.0453
		FA-1-4	4	1.8885	0.925	.0428
		FA-1-5	5	1.8835	0.925	.0403
FA-2*	Ford - OHC Cam Bearing Set (Full Round)	FA-2-1	1	1.8435	0.845	.0403
		FA-2-2	2	1.8535	0.845	.0403
		FA-2-3	3	1.8635	0.845	.0403
		FA-2-4	4	1.8735	0.845	.0403
		FA-2-5	5	1.8835	0.845	.0403
FA-3* .010 und .020 und	Ford - OHC Cam Bearing Set (Half Shell) (One Set Per Head)	FA-3-2(U)	1,2,3,4,5,6	1.1469	0.570	.0422
		FA-3-1(L)	1,2,3,4,5,6	1.1469	0.570	.0422
FA-4*	Ford - OHC Cam Bearing Set (Half Shell) (One Set Per Head)	FA-4-3(U)	1,6,7,12	1.1469	0.570	.0420
		FA-4-4(U)	2,3,4,5,8,9,10,11	1.1469	0.455	.0420
		FA-3-2(L)	1,6,7,12	1.1469	0.570	.0422
		FA-4-1(L)	2,3,4,5	1.1469	0.455	.0420
		FA-4-2(L)	8,9,10,11	1.1469	0.455	.0420
FA-5*	Ford - OHC Cam Bearing Set (Half Shell) (One Set Per Head)	FA-4-3(U)	1,6,7,12	1.1469	0.570	.0420
		FA-4-4(U)	2,3,4,5,8,9,10,11	1.1469	0.455	.0420
		FA-5-1(L)	1,6,7,12	1.1469	0.570	.0422
		FA-4-1(L)	2,3,4,5	1.1469	0.455	.0420
		FA-4-2(L)	8,9,10,11	1.1469	0.455	.0420
FA-6* .010 und .020 und	Ford - OHC Cam Bearing Set (Half Shell)	FA-6-2(U)	1	1.1875	0.960	.0422
		FA-6-4(U)	2,3,4	1.1875	0.680	.0422
		FA-6-1(L)	1	1.1875	0.960	.0422
		FA-6-3(L)	2,3,4	1.1875	0.680	.0422
FA-13L* .010 und .020 und	Ford - OHC Cam Bearing Set (Half Shell)	FA-13-1(L)	1	1.2132	1.215	.0422
		FA-13-2(U)	1	1.2132	1.215	.0422
		FA-13-3(L)	2,3,4,5	1.2132	0.700	.0422
		FA-13-4(U)	2,3,4,5	1.2132	0.700	.0422

*Denotes (OHC) Repair Bearing, Check "Aluminum Overhead Cam Accessories" Section For Tool Information

**Denotes Auxiliary / Balance Shaft Bearing

"und" Denotes Undersized ID

BEARING SET CONTENTS

SET NO.	ENGINE MFG. / DESCRIPTION	CONTENTS	POSITION	HOUSING BORE	LENGTH	MAX WALL
FA-13R* .010 und .020 und	Ford - OHC Cam Bearing Set (Half Shell)	FA-13-2(U)	1	1.2132	1.215	.0422
		FA-13-5(L)	1	1.2132	1.215	.0422
		FA-13-3(L)	2,3,4,5	1.2132	0.700	.0422
		FA-13-4(U)	2,3,4,5	1.2132	0.700	.0422
FA-14L*	Ford - OHC Cam Bearing Set (Half Shell)	FA-3-2(U)	1,3,4,5,7	1.1469	0.570	.0422
		FA-3-1S(U)	2,6	1.1469	0.570	.0422
		FA-3-1(L)	1,2,3,4,5,6,7	1.1469	0.570	.0422
FA-14R*	Ford - OHC Cam Bearing Set (Half Shell)	FA-3-2(U)	1,2,3,4,5,6,7	1.1469	0.570	.0422
		FA-3-1(L)	1,2,3,4,5,6,7	1.1469	0.570	.0422
FG-1-1**	Ford - Balance Shaft Drive Gear Bushing (Bearings Sold Separately)	FG-1-1		2.1430	0.815	.0701
FG-29**	Ford - Balance Shaft Bearing Set	AGB-29-1	1	1.7750	0.500	.0606
FG-34**	Ford, Mazda - Balance Shaft Bearing Set	AGB-34-1	1	1.7975	0.500	.0714
		AGB-34-2	2	1.7775	0.500	.0614
FG-51** .010 und	Ford - Balance Shaft Bearing Set	AGB-51-1	1,2	2.1920	0.635	.0694
FG-53**	Ford - Auxiliary Shaft Bearing Set	FG-53-1	Front	1.8522	1.142	.0610
		FG-53-2	Rear	1.8072	0.905	.0610
FP-01	Ford - HP Cam Bearing Set	FP-01-1	1	2.3095	0.760	.0912
		FP-01-2	3,5	2.3095	0.760	.0912
		FP-01-4	2,4	2.3095	0.760	.0912
FP-01R1	Ford - HP Cam Bearing Set w/ .010 Oversize OD	FP-01-1R1	1	2.3200	0.760	.0962
		FP-01-2R1	3,5	2.3200	0.760	.0962
		FP-01-4R1	2,4	2.3200	0.760	.0962
FP-18	Ford - HP Cam Bearing Set	FP-18-1	1	2.2040	0.660	.0602
		FP-18-2	2	2.1890	0.660	.0602
		FP-18-3	3	2.1740	0.660	.0602
		FP-18-4	4	2.1590	0.660	.0602
		FP-18-5	5	2.1440	0.660	.0602
FP-18T	Ford - HP Cam Bearing Set (Coated)	FP-18-1T	1	2.2040	0.660	.0602
		FP-18-2T	2	2.1890	0.660	.0602
		FP-18-3T	3	2.1740	0.660	.0602
		FP-18-4T	4	2.1590	0.660	.0602
		FP-18-5T	5	2.1440	0.660	.0602
FP-26	Ford - HP Cam Bearing Set	FP-26-1	1	2.2500	0.660	.0616
		FP-18-2	2	2.1890	0.660	.0602
		FP-18-3	3	2.1740	0.660	.0602
		FP-18-4	4	2.1590	0.660	.0602
		FP-18-5	5	2.1440	0.660	.0602
FP-26T	Ford - HP Cam Bearing Set (Coated)	FP-26-1T	1	2.2500	0.660	.0616
		FP-18-2T	2	2.1890	0.660	.0602
		FP-18-3T	3	2.1740	0.660	.0602
		FP-18-4T	4	2.1590	0.660	.0602
		FP-18-5T	5	2.1440	0.660	.0602
FP-30	Ford - HP Cam Bearing Set	FP-30-1	1,2,3,4,5	2.2500	0.580	.0618
FP-30AT	Ford - HP Cam Bearing Set (Coated) w/ Wide No. 1-5 Position	FP-26-1T	1,2,3,4,5	2.2500	0.660	.0616
FP-30R	Ford - HP Cam Bearing Set w/ .005 Oversize OD	FP-30-1R	1,2,3,4,5	2.2550	0.580	.0645
FP-30T	Ford - HP Cam Bearing Set (Coated)	FP-30-1T	1,2,3,4,5	2.2500	0.580	.0618

*Denotes (OHC) Repair Bearing, Check "Aluminum Overhead Cam Accessories" Section For Tool Information

**Denotes Auxiliary / Balance Shaft Bearing

"und" Denotes Undersized ID

BEARING SET CONTENTS

SET NO.	ENGINE MFG. / DESCRIPTION	CONTENTS	POSITION	HOUSING BORE	LENGTH	MAX WALL	
FP-33	Ford - HP Cam Bearing Set	FP-33-1	1	1.7734	0.775	.0604	
		FP-15-2	2	2.2950	0.620	.0841	
		FP-15-3	3	2.2800	0.620	.0766	
		FP-15-4	4	2.2650	0.620	.0691	
		FP-15-5	5	2.2500	0.560	.0616	
FP-33T	Ford - HP Cam Bearing Set (Coated)	FP-33-1T	1	1.7734	0.775	.0604	
		FP-15-2T	2	2.2950	0.620	.0841	
		FP-15-3T	3	2.2800	0.620	.0766	
		FP-15-4T	4	2.2650	0.620	.0691	
		FP-15-5T	5	2.2500	0.560	.0616	
GM-5 .030 und	General Motors - Cam Bearing Set	GM-5-1	1	2.1875	1.680	.0641	
		GM-5-2	2	2.1562	0.880	.0641	
		GM-5-3	3	2.1250	0.880	.0641	
		GM-5-4	4	1.9725	1.150	.0641	
GM-7 .010 und	General Motors - Cam Bearing Set	GM-7-1	1	2.3280	0.895	.0798	
		GM-7-2	2	2.3190	0.775	.0753	
		GM-7-3	3	2.3090	0.775	.0703	
		GM-7-4	4	2.2990	0.775	.0653	
		GM-7-5	5	2.1420	0.775	.0655	
GM-7R2	General Motors - Cam Bearing Set w/ .020 Oversize OD	GM-7-1R2	1	2.3480	0.895	.0898	
		GM-7-2R2	2,3,4	2.3480	0.775	.0898	
		GM-7-5	5	2.1420	0.775	.0655	
GM-8	General Motors - Cam Bearing Set	GM-8-1	1	2.5598	1.120	.0790	
		GM-8-2	2,3,4,5	2.5598	0.705	.0790	
GM-9 .010 und .020 und	General Motors - Cam Bearing Set	CH-10-3	1,2,3,4,5	2.3088	0.630	.0700	
GM-12 .010 und .020 und .030 und	General Motors - Cam Bearing Set	CH-12-3	1,2,3,4,5	2.1200	0.980	.0841	
GM-25	General Motors - Cam Bearing Set	CH-25-3	1,2,3,4,5	2.3088	0.775	.0700	
GMA-1* .020 und	General Motors - OHC Cam Bearing Set (Full Round)	GMA-1-1	1	1.8607	0.817	.0550	
		GMA-1-2	2,3,4,5	1.8607	0.661	.0550	
GMA-2*	General Motors - OHC Cam Bearing Set (Half Shell)	GMA-2-1(U)	1,6	1.2655	0.665	.0617	
		GMA-2-3(U)	2,3,4,5,7,8,9,10	1.2655	0.665	.0617	
		GMA-2-2(L)	1,6	1.2655	0.665	.0617	
		GMA-2-1(L)	2,3,4,5,7,8,9,10	1.2655	0.665	.0617	
GMP-1	General Motors - HP Cam Bearing Set	GMP-1-1	1,2,3,4,5	2.1200	0.755	.0841	
GMP-1T	General Motors - HP Cam Bearing Set (Coated)	GMP-1-1T	1,2,3,4,5	2.1200	0.755	.0841	
GMP-2T	Specialty Aftermarket Blocks - HP Cam Bearing Set (Coated), (OD Groove w/ 3 Hole, 120 Degree Spacing)	GMP-2-1T	1,2,3,4,5	2.1200	0.755	.0841	
GMP-3	Specialty Aftermarket Blocks - HP Cam Bearing Set	GM2125-1	1	2.2500	0.855	.0620	
		GM2125-4	2,3,4,5	2.2500	0.980	.0620	
GMP-3T	Specialty Aftermarket Blocks - HP Cam Bearing Set (Coated)	GM2125-1T	1	2.2500	0.855	.0620	
		GM2125-4T	2,3,4,5	2.2500	0.980	.0620	
GMP-8	General Motors - HP Cam Bearing Set	CHP-4-3	1,2,3,4,5	2.0000	0.740	.0644	
GMP-8T	General Motors - HP Cam Bearing Set (Coated)	CHP-4-3T	1,2,3,4,5	2.0000	0.740	.0644	
GMP-9	Specialty Aftermarket Blocks - HP Cam Bearing Set	CHP-10-3	1,2,3,4,5	2.3088	0.630	.0700	

*Denotes (OHC) Repair Bearing, Check "Aluminum Overhead Cam Accessories" Section For Tool Information

**Denotes Auxiliary / Balance Shaft Bearing

"und" Denotes Undersized ID

BEARING SET CONTENTS

SET NO.	ENGINE MFG. / DESCRIPTION	CONTENTS	POSITION	HOUSING BORE	LENGTH	MAX WALL
GMP-9T	Specialty Aftermarket Blocks - HP Cam Bearing Set (Coated)	CHP-10-3T	1,2,3,4,5	2.3088	0.630	.0700
GMP-12	General Motors - HP Cam Bearing Set	CHP-12-3	1,2,3,4,5	2.1200	0.980	.0841
GMP-12T	General Motors - HP Cam Bearing Set (Coated)	CHP-12-3T	1,2,3,4,5	2.1200	0.980	.0841
GMP-12LT	Specialty Aftermarket Blocks - HP Cam Bearing Set (Coated), (OD Groove w/ 3 Hole, 120 Degree Spacing)	CH-12-3LT	1,2,3,4,5	2.1200	0.980	.0841
GMP-25	General Motors - HP Cam Bearing Set	CHP-25-3	1,2,3,4,5	2.3088	0.775	.0700
GMP-25T	General Motors - HP Cam Bearing Set (Coated)	CHP-25-3T	1,2,3,4,5	2.3088	0.775	.0700
GMP-55	General Motors - HP Cam Bearing Set (OD Groove w/ 3 Hole, 120 Degree Spacing)	GMP-55-1	1,2,3,4,5	2.282	0.785	0.0569
GMP-55T	General Motors - HP Cam Bearing Set (Coated) (OD Groove w/ 3 Hole, 120 Degree Spacing)	GMP-55-1T	1,2,3,4,5	2.282	0.785	0.0569
H-5	American Motors, Honda, Jeep - Cam Bearing Set	H-5-1 H-5-2 H-5-3 H-5-4 H-5-5	1 2 3 4 5	2.1560 2.1460 2.1360 2.1260 1.6260	0.750 0.750 0.750 0.750 1.060	.0620 .0620 .0620 .0620 .0620
HA-1*	Honda - OHC Cam Bearing Set (Half Shell)	HA-1-1(U) HA-1-5(L)	1,2,3,4,5 1,2,3,4,5	1.2655 1.2655	0.700 0.700	.0622 .0622
HA-2* .020 und	Honda - OHC Cam Bearing Set (Half Shell)	HA-1-2(U) HA-1-4(U) HA-1-4A(U) HA-1-5(U) HA-1-3(L) HA-1-5(L)	1 2,4,5 3 6 1 2,3,4,5,6	1.2655 1.2655 1.2655 1.2655 1.2655 1.2655	0.830 0.700 0.700 0.700 0.830 0.700	.0618 .0622 .0622 .0622 .0618 .0622
HA-3* .010 und .020 und	Acura, Honda - OHC Cam Bearing Set (Half Shell)	HA-3-2(U) HA-3-4(U) HA-3-1(L) HA-3-3(L)	1 2,3,4,5,6 1 2,3,4,5,6	1.1875 1.1875 1.1875 1.1875	0.735 0.535 0.735 0.535	.0422 .0422 .0422 .0422
HA-4*	Honda - OHC Cam Bearing Set (Half Shell)	HA-4-1(U) HA-4-3(U) HA-4-2(L) HA-4-4(L)	1 2,3,4,5 1 2,3,4,5	1.2655 1.2655 1.2655 1.2655	1.242 0.530 1.242 0.530	.0618 .0618 .0618 .0618
HA-5*	Acura, Honda - OHC Cam Bearing Set (Half Shell)	HA-5-2(U) HA-3-4(U) HA-5-1(L) HA-3-3(L)	1 2,3,4,5,6,7 1 2,3,4,5,6,7	1.2655 1.1875 1.2655 1.1875	0.788 0.535 0.788 0.535	.0618 .0422 .0618 .0422
HE-1	Hercules, John Deere, Military Standard, Oliver Tractor - Cam Bearing Set	HE-1-1 HE-1-2	1,4 2,3	2.1875 2.1875	1.125 0.812	.0660 .0660
HE-5	Hercules, John Deere, Oliver Tractor - Cam Bearing Set	HE-5-1 HE-5-2	1,4 2,3	1.8753 1.8753	1.020 0.550	.0617 .0617
HE-7	Hercules, Oliver Tractor - Cam Bearing Set	HE-7-1 HE-1-2	1,3 2	2.1875 2.1875	1.057 0.812	.0658 .0660
HE-8	Hercules, Oliver Tractor - Cam Bearing Set	HE-7-1 HE-1-2	1,4 2,3	2.1875 2.1875	1.057 0.812	.0658 .0660
HE-8A	Hercules - Cam Bearing Set	HE-7-1A HE-1-2A	1,4 2,3	2.1862 2.1862	1.057 0.812	.0653 .0653
HO-1	Holden - Cam Bearing Set	HO-1-1	1,2,3,4	1.8968	0.815	.0643

*Denotes (OHC) Repair Bearing, Check "Aluminum Overhead Cam Accessories" Section For Tool Information

**Denotes Auxiliary / Balance Shaft Bearing

"und" Denotes Undersized ID

BEARING SET CONTENTS

SET NO.	ENGINE MFG. / DESCRIPTION	CONTENTS	POSITION	HOUSING BORE	LENGTH	MAX WALL
HO-2 .020 und	Holden - Cam Bearing Set	HO-2-1	1	2.0300	0.785	.0694
		HO-2-2	2	2.0200	0.785	.0644
		HO-2-3	3	2.0100	0.785	.0694
		HO-2-4	4	2.0000	0.785	.0644
		HO-2-5	5	1.7108	0.785	.0644
HO-2S .020 und	Holden - Cam Bearing Set w/ +.002 OD No. 5 Position	HO-2-1	1	2.0300	0.785	.0694
		HO-2-2	2	2.0200	0.785	.0644
		HO-2-3	3	2.0100	0.785	.0694
		HO-2-4	4	2.0000	0.785	.0644
		HO-2-5S	5	1.7128	0.785	.0644
HO-3 .005 und .010 und	Holden - Cam Bearing Set	HO-3-1	1	1.9730	1.000	.0637
		HO-3-2	2	1.9410	0.875	.0637
		HO-3-3	3	1.9100	0.875	.0637
		HO-3-4	4	1.3790	0.875	.0637
HOP-2S .020 und	Holden - HP Cam Bearing Set w/ +.002 OD No. 5 Position	HOP-2-1	1	2.0300	0.785	.0694
		HOP-2-2	2	2.0200	0.785	.0644
		HOP-2-3	3	2.0100	0.785	.0694
		HOP-2-4	4	2.0000	0.785	.0644
		HOP-2-5S	5	1.7128	0.785	.0644
HOP-2ST .020 und	Holden - HP Cam Bearing Set (Coated) w/ +.002 OD No. 5 Position	HOP-2-1T	1	2.0300	0.785	.0694
		HOP-2-2T	2	2.0200	0.785	.0644
		HOP-2-3T	3	2.0100	0.785	.0694
		HOP-2-4T	4	2.0000	0.785	.0644
		HOP-2-5ST	5	1.7128	0.785	.0644
IN-3	IHC - Cam Bearing Set	IN-3A-1	1	2.2408	1.125	.0647
		IN-8-2	2	2.2207	1.062	.0647
		IN-2-3	3	2.2008	1.062	.0645
		IN-2-4	4	1.6313	1.530	.0645
IN-5	IHC - Cam Bearing Set	IN-5-1	1	2.3748	1.438	.0644
		IN-5-2	2	2.2493	1.469	.0642
		IN-5-3	3	1.9993	1.063	.0643
IN-10A	IHC - Cam Bearing Set	IN-10-1A	1	2.4748	1.187	.0618
		IN-10-2	2	2.4438	1.000	.0625
		IN-10-3	3	2.4153	1.000	.0613
		IN-10-4A	4	2.3748	1.000	.0618
IN-11 .010 und .020 und .030 und	IHC, Military Standard - Cam Bearing Set	IN-11-1	1	2.2313	0.710	.0647
		IN-11-2	2	2.2213	0.645	.0647
		IN-11-3	3	2.2113	0.645	.0647
		IN-11-4	4	2.2013	0.645	.0647
		IN-11-5	5	2.1913	0.750	.0647
IN-12	IHC - Cam Bearing Set	IN-3A-1	1	2.2408	1.125	.0647
		IN-8-2	2	2.2207	1.062	.0647
		IN-8-3	3	2.2007	1.062	.0647
IN-14 .010 und .020 und .030 und	IHC - Cam Bearing Set	IN-3A-1	1	2.2408	1.125	.0647
		IN-8-2	2	2.2207	1.062	.0647
		IN-8-3	3	2.2007	1.062	.0647
		IN-8-4	4	1.6313	1.312	.0645
IN-15	IHC - Cam Bearing Set	IN-15-1	1	2.0618	1.000	.0643
		IN-15-2	2	1.9368	1.375	.0643
		IN-15-3	3	1.4993	1.000	.0643
IN-16	IHC - Cam Bearing Set	IN-16-1	1	2.5610	1.125	.0645
		IN-8-2	2	2.2207	1.062	.0647
		IN-16-3	3	2.2010	1.060	.0645
		IN-2-4	4	1.6313	1.530	.0645

*Denotes (OHC) Repair Bearing, Check "Aluminum Overhead Cam Accessories" Section For Tool Information

**Denotes Auxiliary / Balance Shaft Bearing

"und" Denotes Undersized ID

BEARING SET CONTENTS

SET NO.	ENGINE MFG. / DESCRIPTION	CONTENTS	POSITION	HOUSING BORE	LENGTH	MAX WALL
IN-17 .010 und	Ford, IHC - Cam Bearing Set	IN-17-1	1	2.2313	0.785	.0647
		IN-17-2	2,3,4,5	2.2313	0.650	.0647
IN-17R2	Ford, IHC - Cam Bearing Set w/ .020 Oversize OD (.005 Undersize Cam Journal)	IN-17-1S	1	2.2513	0.785	.0768
		IN-17-2S	2,3,4,5	2.2513	0.650	.0768
IN-18	IHC - Cam Bearing Set	IN-18-1	1	1.9430	1.095	.0645
		IN-18-2	2	1.7083	1.005	.0641
		IN-18-3	3	1.6303	0.790	.0641
IN-19	IHC - Cam Bearing Set	IN-19-1	1	2.5013	1.010	.1078
		IN-19-2	2	2.4813	0.709	.0980
		IN-19-3	3	2.4613	0.709	.0880
		IN-19-4	4	2.4413	0.710	.0780
IN-21	Ford, IHC - Cam Bearing Set	IN-21-1	1,2,3,4,5	2.5984	0.740	.0778
IZ-2	General Motors, Isuzu, Jeep - Cam Bearing Set	IZ-2-1	1	2.0479	0.984	.0790
		IZ-2-2	2	2.0480	0.984	.0790
		IZ-2-3	3	2.0480	0.984	.0790
IZ-3	General Motors, Isuzu - Cam Bearing Set	IZ-3-1	1	2.0486	0.866	.0797
		IZ-3-2	2	2.0486	0.866	.0797
		IZ-3-3	3	2.0486	0.866	.0797
IZ-5	Isuzu - Cam Bearing Set	IZ-5-1	2	2.1274	0.984	.0797
		IZ-5-2	2,3	2.1274	0.866	.0797
IZ-6	Isuzu - Cam Bearing Set	IZ-6-1	1	2.3637	0.787	.0785
		IZ-6-2	2,3,4	2.3637	0.787	.0785
IZ-7	Isuzu - Cam Bearing Set	IZ-6-1	1	2.3637	0.787	.0785
		IZ-6-2	2,3	2.3637	0.787	.0785
IZ-8	Isuzu - Cam Bearing Set	IZ-6-1	1	2.3637	0.787	.0785
		IZ-6-2	2,3,4,5,6	2.3637	0.787	.0785
J-1 .010 und .020 und .030 und	IHC, Jeep, Military Standard - Cam Bearing Set	J-1-1	1	2.3165	1.125	.0645
JD-1	John Deere - Cam Bearing Set	JD-1-1	1	1.9280	1.181	.0579
		JD-1-2	2,3	1.9280	0.938	.0579
JD-2	John Deere - Cam Bearing Set	JD-1-1	1	1.9280	1.181	.0579
		JD-1-2	2,3,4	1.9280	0.938	.0579
JD-3	John Deere - Cam Bearing Set	JD-3-1	1,2,3	2.5000	1.000	.0614
JD-4	John Deere - Cam Bearing Set	JD-3-1	1,2,3,4	2.5000	1.000	.0614
JD-5	John Deere - Cam Bearing Set	JD-5-1	1	1.9280	1.598	.0577
		JD-5-2	2	1.9280	1.220	.0577
JDG-7**	John Deere - Balance Shaft Bearing Set	JDG-7-1	1,2,3,4,5,6	1.6250	1.090	.0608
K-1 .010 und .020 und .030 und	Checker, Continental, Jeep, Mack, Military Standard, Oliver Tractor - Cam Bearing Set	K-1-1	1	2.0000	0.875	.0628
		K-1-2	2	1.9375	0.937	.0630
		K-1-3	3	1.8810	1.620	.0628
		K-1-4	4	1.3748	1.156	.0628
LR-1	Rover - Cam Bearing Set	LR-1-1	1	1.9165	0.750	.0642
		B-6-1	2	1.8865	0.750	.0642
		B-4-3	3	1.8565	0.750	.0643
		B-4-4	4	1.8265	0.750	.0643
		B-4-5	5	1.7965	0.750	.0643

*Denotes (OHC) Repair Bearing, Check "Aluminum Overhead Cam Accessories" Section For Tool Information

**Denotes Auxiliary / Balance Shaft Bearing

"und" Denotes Undersized ID

BEARING SET CONTENTS

SET NO.	ENGINE MFG. / DESCRIPTION	CONTENTS	POSITION	HOUSING BORE	LENGTH	MAX WALL
MA-5	Mack - Cam Bearing Set	MA-5-1	1	2.6235	1.385	.0910
		MA-5-2	2,5	2.6235	1.010	.0905
		MA-5-3	3,4,6	2.6235	1.010	.0910
		MA-5-4	7	2.6235	1.380	.1853
MA-6	Mack - Cam Bearing Set	MA-5-1	1	2.6235	1.385	.0910
		MA-5-3	2,3,4,5,6	2.6235	1.010	.0910
		MA-3A-1	7	2.6235	1.380	.1852
MA-7	Mack - Cam Bearing Set	MA-5-1	1	2.6235	1.385	.0910
		MA-5-3	2,3,4,5,6,7	2.6235	1.010	.0910
MA-8	Mack - Cam Bearing Set	MA-8-1	1	2.6235	1.385	.0905
		MA-5-3	2,3,4,5,6,7	2.6235	1.010	.0910
MA-11	Mack - Cam Bearing Set	MA-11-1	(5 pcs.)	2.8735	1.000	.0908
		MA-11-2	(2 pcs.)	2.8735	1.181	.0908
MAG-10**	Mack - Auxiliary Shaft Bearing Set	MAG-10-1	Front	2.3115	1.760	.1237
		MAG-10-2	Rear	2.2495	1.760	.1243
MAG-11**	Mack - Auxiliary Shaft Bearing Set	MAG-11-1	(2 pcs.)	2.3115	1.750	.1235
MIA-1* .010 und .020 und	Chrysler, Eagle, General Motors, Hyundai, Isuzu, Mazda, Mitsubishi - OHC Cam Bearing Set (Half Shell)	MIA-1-3(U)	1	1.4225	0.795	.0422
		MIA-1-1(U)	2,3,4,5	1.4225	0.795	.0422
		MIA-1-4(L)	1,2,3,4,5	1.4225	0.795	.0422
MIA-2* .020 und	Chrysler, Eagle, General Motors, Hyundai, Isuzu, Mazda, Mitsubishi - OHC Cam Bearing Set (Half Shell) w/ Heavy Wall .020 Oversize OD	MIA-1-7(U)	1	1.4971	0.793	.0792
		MIA-1-5(U)	2,3,4,5	1.4971	0.793	.0792
		MIA-1-6(L)	1,2,3,4,5	1.4971	0.793	.0792
MIA-3*	Chrysler, Eagle, Hyundai, Mitsubishi - OHC Cam Bearing Set (Full Round)	MIA-3-1	1,2,3	1.8918	0.685	.0403
MIA-4*	Mitsubishi - OHC Cam Bearing Set (Half Shell)	MIA-1-8(U)	1,5	1.4225	0.795	.0422
		MIA-1-1(U)	2,3,4	1.4225	0.795	.0422
		MIA-1-4(L)	1,2,3,4,5	1.4225	0.795	.0422
MIA-5* (One Set Per Head)	Chrysler, Mitsubishi - OHC Cam Bearing Set (Half Shell)	MIA-5-1(U)	1	1.4225	0.793	.0422
		MIA-5-2(U)	2	1.4225	0.710	.0422
		MIA-5-3(U)	3	1.4225	0.760	.0422
		MIA-5-8(U)	4	1.4225	0.980	.0422
		MIA-5-5(L)	1	1.4225	0.793	.0422
		MIA-5-6(L)	2	1.4225	0.710	.0422
		MIA-5-7(L)	3	1.4225	0.760	.0422
		MIA-5-9(L)	4	1.4225	0.980	.0422
MIG-2** .010 und .020 und	Chrysler, Ford, Mazda, Mitsubishi - Auxiliary Shaft Bearing Set	MIG-2-1	1,2	1.8126	0.785	.0587
		MIG-2-2	3	1.0240	0.703	.0589
MIG-2E**	Chrysler, Ford, Mazda, Mitsubishi - Balance Shaft Eliminator	MIG-1-EL		1.8126	0.930	NA
		MIG-2-EL		0.6330	0.875	NA
MIG-2-1R**	Chrysler, Ford, Mazda, Mitsubishi - Balance Shaft Bearing w/ .173 Oversize OD (Bearings Sold Separately)	MIG-2-1R	1	1.9855	0.788	.1450
MIG-3**	Chrysler, Eagle, Mitsubishi - Balance Shaft Bearing Set	MIG-3-1	1	1.7721	0.745	.0590
		MIG-3-2	2,3	1.7328	0.825	.0592
MZA-1* .020 und	Ford, Mazda - OHC Cam Bearing Set (Full Round)	MZA-1-1	1	1.7931	0.730	.0403
		MZA-1-2	2	1.7931	0.730	.0403
		MZA-1-3	3	1.7931	0.730	.0403
MZA-2* .020 und	Ford, Mazda - OHC Cam Bearing Set (Half Shell)	MZA-2-3(U)	1,5	1.3439	0.830	.0422
		MZA-2-1(U)	2,3,4	1.3439	0.700	.0422
		MZA-2-2(L)	1,2,3,4,5	1.3439	0.830	.0422
MZA-4*	Mazda - OHC Cam Bearing Set (Half Shell)	MZA-4-1(U)	1,2,3,4,5	1.2655	0.700	.0422
		VHA-1-2(L)	1,2,3,4,5	1.2655	0.700	.0422

*Denotes (OHC) Repair Bearing, Check "Aluminum Overhead Cam Accessories" Section For Tool Information

**Denotes Auxiliary / Balance Shaft Bearing

"und" Denotes Undersized ID

BEARING SET CONTENTS

SET NO.	ENGINE MFG. / DESCRIPTION	CONTENTS	POSITION	HOUSING BORE	LENGTH	MAX WALL
MZG-3** .010 und	Mazda - Balance Shaft Bearing Set	MZG-3-1	Front (2 pcs.)	1.8114	0.910	.0781
		MZG-3-2	Middle (2 pcs.)	1.7326	1.030	.0780
		MZG-3-3	Rear (2 pcs.)	0.9453	0.635	.0585
N-6	American Motors - Cam Bearing Set	N-6-1	1	1.9470	0.940	.0647
		N-5-2	2	1.9370	0.780	.0647
		N-5-3	3	1.9270	0.780	.0647
		N-5-4	4	1.9170	0.810	.0647
N-7 .010 und .020 und .030 und .040 und	American Motors, Eagle, IHC, Jeep - Cam Bearing Set	N-7-1	1	2.1560	0.690	.0620
		N-7-2	2	2.1460	0.690	.0620
		N-7-3	3	2.1360	0.690	.0620
		N-7-4	4	2.1260	0.690	.0620
N-7B	American Motors, Eagle, IHC, Jeep - Special Oil Control Cam Bearing Set w/ OD Groove No. 2, 3 Position	N-7-1	1	2.1560	0.690	.0620
		N-7-2B	2	2.1460	0.690	.0620
		N-7-3B	3	2.1360	0.690	.0620
		N-7-4	4	2.1260	0.690	.0620
N-7BW	American Motors, Eagle, IHC, Jeep - Special Oil Control Cam Bearing Set w/ OD Groove No. 2, 3 Position w/ .001 Undersize ID	N-7-1X001	1	2.1560	0.690	.0625
		N-7-2BX001	2	2.1460	0.690	.0625
		N-7-3BX001	3	2.1360	0.690	.0625
		N-7-4X001	4	2.1260	0.690	.0625
N-9 .010 und .020 und .030 und	American Motors, IHC, Jeep - Cam Bearing Set	N-9-1	1	2.2460	0.920	.0620
		N-8-2	2	2.2160	0.625	.0620
		N-8-3	3	2.1860	0.625	.0620
		N-8-4	4	2.1560	0.625	.0620
		N-8-5	5	2.1260	0.625	.0620
N-9R1	American Motors, IHC, Jeep - Cam Bearing Set w/ .010 Oversize OD	N-9-11	1	2.2560	0.920	.0670
		N-8-21	2	2.2260	0.625	.0670
		N-8-31	3	2.1960	0.625	.0670
		N-8-41	4	2.1660	0.625	.0670
		N-8-51	5	2.1360	0.625	.0670
N-10	Jeep - Cam Bearing Set	N-10-1	1	2.1560	0.690	.0620
		N-7-2	2	2.1460	0.690	.0620
		N-7-3	3	2.1360	0.690	.0620
		N-7-4	4	2.1260	0.690	.0620
NIA-1*	Nissan - OHC Cam Bearing Set (Full Round)	NIA-1-1	1,2,3,4,5	1.7340	0.805	.0403
NIA-2L*	Nissan - OHC Cam Bearing Set (Full Round) (Left Bank)	NIA-2-1	1,2,3,4	1.9309	0.735	.0403
NIA-2R*	Nissan - OHC Cam Bearing Set (Full Round) (Right Bank)	NIA-2-1	1,2,3,4,5	1.9309	0.735	.0403
NIA-3L*	Ford, Nissan - OHC Cam Bearing Set (Full Round) (Left Bank)	NIA-2-1	1,2,3	1.9309	0.735	.0403
		NIA-3-2	4	1.7538	0.735	.0403
NIA-3R*	Ford, Nissan - OHC Cam Bearing Set (Full Round) (Right Bank)	NIA-3-1	1	1.9702	1.235	.0403
		NIA-2-1	2,3,4	1.9309	0.735	.0403
		NIA-3-2	5	1.7538	0.735	.0403
NIA-4* .020 und	Nissan - OHC Cam Bearing Set (Full Round)	NIA-1-1	1,2,4	1.7340	0.805	.0403
		NIA-1-2	3	1.7340	0.805	.0403
		NIA-1-3	5	1.7340	1.120	.0403
NIA-5*	Nissan - OHC Cam Bearing Set (Full Round)	NIA-4-1	1,2,3,5	1.8914	0.805	.0403
		NIA-4-2	4	1.8914	0.805	.0403
NIA-6* .020 und	Nissan - OHC Cam Bearing Set (Half Shell)	TOA-1-1(U)	1,2,3,4,5	1.3841	0.800	.0422
		TOA-1-2(L)	1,2,3,4,5	1.3841	0.800	.0422
NIG-1**	Nissan - Balance Shaft Bearing Set	NIG-1-1	Front (2 pcs.)	2.1255	0.628	.0595
		NIG-1-2	Rear (2 pcs.)	2.1183	0.825	.0595

*Denotes (OHC) Repair Bearing, Check "Aluminum Overhead Cam Accessories" Section For Tool Information

**Denotes Auxiliary / Balance Shaft Bearing

"und" Denotes Undersized ID

BEARING SET CONTENTS

SET NO.	ENGINE MFG. / DESCRIPTION	CONTENTS	POSITION	HOUSING BORE	LENGTH	MAX WALL
O-5	General Motors - Cam Bearing Set	O-5-1	1,2,3,4,5	2.1288	0.688	.0641
O-6 .010 und	General Motors - Cam Bearing Set	O-6-1	1	2.1688	0.688	.0646
		O-6-2	2	2.1488	0.688	.0646
		O-6-3	3	2.1288	0.688	.0646
		O-6-4	4	2.1088	0.688	.0646
		O-6-5	5	2.0888	0.688	.0646
O-6B	General Motors - Special Oil Control Cam Bearing Set w/ OD Groove	O-6-1B	1	2.1688	0.688	.0646
		O-6-2B	2	2.1488	0.688	.0646
		O-6-3B	3	2.1288	0.688	.0646
		O-6-4B	4	2.1088	0.688	.0646
		O-6-5B	5	2.0888	0.688	.0646
O-7 .010 und	General Motors - Cam Bearing Set	O-7-1	1	2.1688	0.688	.0646
		O-6-2	2	2.1488	0.688	.0646
		O-6-3	3	2.1288	0.688	.0646
		O-6-4	4	2.1088	0.688	.0646
		O-6-5	5	2.0888	0.688	.0646
O-8	General Motors - Cam Bearing Set	O-7-1	1	2.1688	0.688	.0646
		O-6-2	2	2.1488	0.688	.0646
		O-6-3	3	2.1288	0.688	.0646
		O-6-4	4	2.1088	0.688	.0646
OG-1**	General Motors - Balance Shaft Bearing Set	OG-1-1	1,2	2.1408	0.740	.0695
ON-1	Onan - Cam Bearing Set	ON-1-1	1,2	1.5000	0.697	.0619
OP-3	Opel - Cam Bearing Set	OP-3-1	1	2.1069	0.950	.0889
		OP-3-2	2	2.0970	0.723	.0889
		OP-3-3	3	2.0773	0.723	.0840
OP-5	Opel - Cam Bearing Set	OP-3-1	1	2.1069	0.950	.0889
		OP-3-2	2	2.0970	0.723	.0889
		OP-5-3	3	2.0872	0.723	.0865
		OP-3-3	4	2.0773	0.723	.0840
P-3 .010 und .020 und .030 und	General Motors - Cam Bearing Set	P-3-1	1	2.0307	1.060	.0644
		P-3-2	2,3,4,5	2.0307	0.680	.0644
P-4 .010 und .020 und .030 und	General Motors - Cam Bearing Set	P-3-2	1,2,3,4,5	2.0307	0.680	.0644
P-4R1	General Motors - Cam Bearing Set w/ .010 Oversize OD	P-3-21	1,2,3,4,5	2.0407	0.680	.0694
PD-1 .010 und .020 und	Chrysler, Military Standard - Cam Bearing Set	PD-1-1	1	2.1295	1.093	.0645
		PD-1-2	2	2.0990	0.875	.0649
		PD-1-3	3	2.0675	0.875	.0650
PD-3 .010 und .020 und .030 und	Chrysler, Military Standard, Oliver Tractor - Cam Bearing Set	PD-1-1	1	2.1295	1.093	.0645
		PD-3-2	2	2.0990	1.062	.0650
		PD-3-3	3	2.0675	1.062	.0650
PD-8 .010 und .020 und .030 und	Chrysler - Cam Bearing Set	PD-8-1	1	2.1300	0.938	.0647
		PD-8-2	2,3,4	2.1300	0.813	.0647
		PD-8-3	5	1.5675	0.875	.0647

*Denotes (OHC) Repair Bearing, Check "Aluminum Overhead Cam Accessories" Section For Tool Information

**Denotes Auxiliary / Balance Shaft Bearing

"und" Denotes Undersized ID

BEARING SET CONTENTS

SET NO.	ENGINE MFG. / DESCRIPTION	CONTENTS	POSITION	HOUSING BORE	LENGTH	MAX WALL
PD-16 .010 und .020 und .030 und	Chrysler - Cam Bearing Set	PD-16-1	1	2.1300	0.875	.0645
		PD-9-2	2	2.1140	0.760	.0645
		PD-9-3	3	2.0990	0.760	.0645
		PD-9-4	4	2.0830	0.760	.0645
		PD-9-5	5	1.6925	0.940	.0645
PD-17 .010 und .020 und .030 und	Chrysler, Mack, Military Standard - Cam Bearing Set	PD-17-1	1	2.1300	0.750	.0645
		PD-12-2	2	2.1140	0.750	.0645
		PD-12-3	3	2.0990	0.669	.0645
		PD-12-4	4	2.0830	0.750	.0645
		PD-12-5	5	1.8800	0.750	.0645
PD-18 .010 und .020 und .030 und	Chrysler, John Deere - Cam Bearing Set	PD-18-1	1	2.1300	0.920	.0645
		PD-12-2	2	2.1140	0.750	.0645
		PD-13-3	3	2.0990	0.750	.0645
		PD-13-4	4	2.0830	0.750	.0645
PD-21 .010 und .020 und	Chrysler, John Deere - Cam Bearing Set	PD-21-1	1	2.1300	0.780	.0640
		PD-21-2	2	2.1140	0.625	.0640
		PD-21-3	3	2.0990	0.625	.0640
		PD-13-4	4	2.0830	0.750	.0645
PD-25 .010 und .020 und	Chrysler, Jeep - Cam Bearing Set	PD-16-1	1	2.1300	0.875	.0645
		PD-25-2	2	2.1140	0.625	.0645
		PD-25-3	3	2.0990	0.615	.0645
		PD-25-4	4	2.0830	0.615	.0645
		PD-9-5	5	1.6925	0.940	.0645
PD-27 .010 und	Chrysler - Cam Bearing Set	PD-16-1	1	2.1300	0.875	.0645
		PD-25-2	2	2.1140	0.625	.0645
		PD-25-4	3	2.0830	0.615	.0645
		PD-9-5	4	1.6925	0.940	.0645
PD-28 .010 und .020 und .030 und	Chrysler, Eagle - Cam Bearing Set	PD-28-1	1	2.1300	0.930	.0647
		PD-28-2	2	2.1140	0.610	.0653
		PD-28-3	3	2.0990	0.610	.0653
		PD-28-4	4	2.0830	0.610	.0647
PD-28B .010 und	Chrysler, Eagle - Special Oil Control Cam Bearing Set w/ OD Groove No. 2, 3 Position	PD-28-1	1	2.1300	0.930	.0647
		PD-28-2B	2	2.1140	0.610	.0653
		PD-28-3B	3	2.0990	0.610	.0653
		PD-28-4	4	2.0830	0.610	.0647
PD-30	Chrysler - Cam Bearing Set	PD-30-1	1	2.2235	0.885	.0650
		PD-30-2	2	2.2075	0.625	.0652
		PD-30-3	3	2.1915	0.625	.0650
		PD-30-4	4	2.1755	0.625	.0650
		PD-30-5	5	2.1595	0.625	.0650
		PD-30-6	6	2.0495	0.885	.0650
PD-31B	Chrysler - Cam Bearing Set	PD-31-1B	1	2.4231	0.665	.0650
		PD-31-2B	2	2.4073	0.587	.0650
		PD-31-3B	3	2.3916	0.587	.0650
		PD-31-4B	4	2.3758	0.587	.0650
		PD-31-5B	5	1.8499	0.587	.0650
PD-31BW	Chrysler - Cam Bearing Set w/ .001 Undersize ID	PD-31-1W	1	2.4231	0.665	.0655
		PD-31-2W	2	2.4073	0.587	.0655
		PD-31-3W	3	2.3916	0.587	.0655
		PD-31-4W	4	2.3758	0.587	.0655
		PD-31-5W	5	1.8499	0.587	.0655
PDA-1*	Chrysler - OHC Cam Bearing Set (Half Shell)	PDA-1-2(U)	1,2,3,4,5	1.4819	0.625	.0522
		PDA-1-1(L)	1,2,3,4,5	1.4819	0.625	.0522
PDA-2*	Chrysler - OHC Cam Bearing Set (Half Shell)	PDA-2-2(U)	1,2,3,4,5	1.4819	0.625	.0422
		PDA-2-1(L)	1,2,3,4,5	1.4819	0.625	.0422

*Denotes (OHC) Repair Bearing, Check "Aluminum Overhead Cam Accessories" Section For Tool Information

**Denotes Auxiliary / Balance Shaft Bearing

"und" Denotes Undersized ID

BEARING SET CONTENTS

SET NO.	ENGINE MFG. / DESCRIPTION	CONTENTS	POSITION	HOUSING BORE	LENGTH	MAX WALL
PDA-3*	Chrysler - OHC Cam Bearing Set (Full Round)	PDA-3-1	1	1.7035	0.815	.0404
		PDA-3-2	2	1.7195	0.775	.0406
		PDA-3-3	3	1.7345	0.775	.0402
		PDA-3-4	4	1.7505	0.775	.0404
		PDA-3-5	5	1.7665	0.745	.0404
PDA-4* .010 und	Chrysler - OHC Cam Bearing Set (Half Shell)	PDA-4-2 (U)	1,2,3,4,5	1.1085	0.585	.0418
		PDA-4-1 (L)	1,2,3,4,5	1.1085	0.585	.0418
PDG-1**	Chrysler - Auxiliary Shaft Bearing Set	PDG-1-1	1,2	1.3390	0.785	.0789
PDG-26**	Chrysler, Mitsubishi - Balance Shaft Bearing Set	PDG-26-1	1	1.8110	0.745	.0640
		PDG-26-2	2	0.9055	0.825	.0640
PDG-29S** .020 und	Chrysler - Balance Shaft Bearing Set (Semi-Finished)	PDG-29-1	Both	1.7866	0.865	.08 Semi
PDG-30**	Chrysler - Balance Shaft Bearing Set	PDG-30-1	1	2.3533	0.710	.0728
		PDG-30-2	2	1.2903	0.710	.0728
PDP-16	Chrysler - HP Cam Bearing Set	PDP-16-1	1	2.1300	0.875	.0645
		PDP-9-2	2	2.1140	0.760	.0645
		PDP-9-3	3	2.0990	0.760	.0645
		PDP-9-4	4	2.0830	0.760	.0645
		PDP-9-5	5	1.6925	0.940	.0645
PDP-16T	Chrysler - HP Cam Bearing Set (Coated)	PDP-16-1T	1	2.1300	0.875	.0645
		PDP-9-2T	2	2.1140	0.760	.0645
		PDP-9-3T	3	2.0990	0.760	.0645
		PDP-9-4T	4	2.0830	0.760	.0645
		PDP-9-5T	5	1.6925	0.940	.0645
PDP-17	Chrysler, Mack, Military Standard - HP Cam Bearing Set	PDP-17-1	1	2.1300	0.750	.0645
		PDP-12-2	2	2.1140	0.750	.0645
		PDP-12-3	3	2.0990	0.669	.0645
		PDP-12-4	4	2.0830	0.750	.0645
		PDP-12-5	5	1.8800	0.750	.0645
PDP-17R1	Chrysler, Mack, Military Standard - HP Cam Bearing Set w/ .010 Oversize OD	PDP-17-1R1	1	2.1400	0.750	.0695
		PDP-12-2R1	2	2.1240	0.750	.0695
		PDP-12-3R1	3	2.1090	0.669	.0695
		PDP-12-4R1	4	2.0930	0.750	.0695
		PDP-12-5R1	5	1.8900	0.750	.0695
PDP-17T	Chrysler, Mack, Military Standard - HP Cam Bearing Set (Coated)	PDP-17-1T	1	2.1300	0.750	.0645
		PDP-12-2T	2	2.1140	0.750	.0645
		PDP-12-3T	3	2.0990	0.669	.0645
		PDP-12-4T	4	2.0830	0.750	.0645
		PDP-12-5T	5	1.8800	0.750	.0645
PDP-25	Chrysler, Jeep - HP Cam Bearing Set	PDP-16-1	1	2.1300	0.875	.0645
		PDP-25-2	2	2.1140	0.625	.0645
		PDP-25-3	3	2.0990	0.615	.0645
		PDP-25-4	4	2.0830	0.615	.0645
		PDP-9-5	5	1.6925	0.940	.0645
PDP-25T	Chrysler, Jeep - HP Cam Bearing Set (Coated)	PDP-16-1T	1	2.1300	0.875	.0645
		PDP-25-2T	2	2.1140	0.625	.0645
		PDP-25-3T	3	2.0990	0.615	.0645
		PDP-25-4T	4	2.0830	0.615	.0645
		PDP-9-5T	5	1.6925	0.940	.0645
PP-3	General Motors - HP Cam Bearing Set	PP-3-1	1	2.0307	1.060	.0644
		PP-3-2	2,3,4,5	2.0307	0.680	.0644
PP-3T	General Motors - HP Cam Bearing Set (Coated)	PP-3-1T	1	2.0307	1.060	.0644
		PP-3-2T	2,3,4,5	2.0307	0.680	.0644

*Denotes (OHC) Repair Bearing, Check "Aluminum Overhead Cam Accessories" Section For Tool Information

**Denotes Auxiliary / Balance Shaft Bearing

"und" Denotes Undersized ID

BEARING SET CONTENTS

SET NO.	ENGINE MFG. / DESCRIPTION	CONTENTS	POSITION	HOUSING BORE	LENGTH	MAX WALL
PP-4	General Motors - HP Cam Bearing Set	PP-3-2	1,2,3,4,5	2.0307	0.680	.0644
PP-4T	General Motors - HP Cam Bearing Set (Coated)	PP-3-2T	1,2,3,4,5	2.0307	0.680	.0644
R-1	Reo Motor Truck - Cam Bearing Set	R-1-1	1	2.5620	1.625	.0610
		R-1-2	2	2.4370	1.250	.0610
		R-1-3	3	2.3120	1.250	.0610
		R-1-4	4	1.7500	1.187	.0613
RDC-1	Rodeck - Cam Bearing Set	CH-4-3	1	2.0000	0.740	.0644
		CH-5-3	2,3,4,5	2.0000	0.860	.0644
RDCP-1	Rodeck - HP Cam Bearing Set	CHP-4-3	1	2.0000	0.740	.0644
		CHP-5-3	2,3,4,5	2.0000	0.860	.0644
RDCP-1T	Rodeck - HP Cam Bearing Set (Coated)	CHP-4-3T	1	2.0000	0.740	.0644
		CHP-5-3T	2,3,4,5	2.0000	0.860	.0644
SA-1*	General Motors, Suzuki - OHC Cam Bearing Set (Full Round)	SA-1-1	1	1.8215	0.940	.0407
		SA-1-2	2	1.8295	0.485	.0407
		SA-1-3	3	1.8375	0.485	.0407
		SA-1-4	4	1.8455	0.485	.0407
		SA-1-5	5	1.8535	0.485	.0407
SBF-1T	Specialty Aftermarket Blocks - HP Cam Bearing Set (Coated), (OD Groove w/ 3 Hole, 120 Degree Spacing)	351-HPB-1T	1	2.2040	0.660	.0602
		351-HPB-2T	2	2.2040	0.660	.0677
		351-HPB-3T	3	2.2040	0.660	.0752
		351-HPB-4T	4	2.2040	0.660	.0827
		351-HPB-5T	5	2.2040	0.660	.0902
SBF-1R1T	Specialty Aftermarket Blocks - HP Cam Bearing Set (Coated) w/ .010 Oversize OD (OD Groove w/ 3 Hole, 120 Degree Spacing)	351-HPB-1R1T	1	2.2140	0.660	.0652
		351-HPB-2R1T	2	2.2140	0.660	.0727
		351-HPB-3R1T	3	2.2140	0.660	.0802
		351-HPB-4R1T	4	2.2140	0.660	.0877
		351-HPB-5R1T	5	2.2140	0.660	.0952
TO-2	Toyota - Cam Bearing Set	TO-2-1	1	1.9685	1.095	.0685
		TO-2-2	2	1.9685	1.654	.0735
		TO-2-3	3	1.9685	0.985	.0785
TO-3	Toyota - Cam Bearing Set	TO-3-1	1	1.8895	0.715	.0929
		TO-3-2	2	1.8705	0.715	.0885
		TO-3-3	3	1.8510	0.715	.0835
		TO-3-4	4	1.8311	0.715	.0786
TO-7	Toyota - Cam Bearing Set	TO-7-1	1	1.9691	0.705	.0687
		TO-7-2	2	1.9593	0.625	.0687
		TO-7-3	3	1.9297	0.705	.0588
		TO-7-4	4	1.9400	0.625	.0687
		TO-7-5	5	1.9494	0.705	.0785
TO-8	Toyota - Cam Bearing Set	TO-8-1	1	1.4971	1.103	.0591
		TO-8-2	2,3,4	1.4971	0.793	.0591
TO-10	Toyota - Cam Bearing Set	TO-1-1	1	2.0475	1.143	.0785
		TO-1-2	2	1.9885	0.943	.0785
		TO-10-3	3	1.9295	0.943	.0785
		TO-1-4	4	1.8705	0.984	.0785
TO-11	Toyota - Cam Bearing Set	TO-5-1	1	1.9688	1.142	.0686
		TO-5-2	2	1.9688	0.790	.0735
		TO-11-3	3	1.9688	1.810	.0785
		TO-5-4	4	1.9688	0.750	.0835
		TO-5-5	5	1.9688	1.105	.0884

*Denotes (OHC) Repair Bearing, Check "Aluminum Overhead Cam Accessories" Section For Tool Information

**Denotes Auxiliary / Balance Shaft Bearing

"und" Denotes Undersized ID

BEARING SET CONTENTS

SET NO.	ENGINE MFG. / DESCRIPTION	CONTENTS	POSITION	HOUSING BORE	LENGTH	MAX WALL
TO-12	Toyota - Cam Bearing Set	TO-12-1	1	1.9697	0.709	.0689
		TO-12-2	2	1.9598	0.630	.0689
		TO-12-3	3	1.9303	0.709	.0591
		TO-12-4	4	1.9402	0.630	.0689
		TO-12-5	5	1.9500	0.709	.0788
TO-15	Toyota - Cam Bearing Set	TO-15-1	1	2.2638	0.787	.0791
		TO-15-2	2	2.2539	0.787	.0791
		TO-15-3	3	2.2047	0.787	.0594
		TO-15-4	4	2.2047	0.787	.0644
		TO-15-5	5	2.2146	0.787	.0742
TOA-1*	Toyota - OHC Cam Bearing Set (Half Shell)	TOA-2-2(U)	1,2,3	1.3841	0.800	.0418
		TOA-2-1(L)	1,2,3	1.3841	0.800	.0418
TOG-8**	Toyota - Balance Shaft Bearing Set	TOG-8-1	1	1.9682	0.975	.0784
		TOG-8-2	2	1.7714	0.785	.0784
TOG-9**	Toyota - Auxiliary Shaft Bearing Set	TOG-9-1	1	1.7719	0.640	.0788
		TOG-9-2	2	1.4569	0.640	.0788
TOG-10**	Toyota - Balance Shaft Bearing Set	TOG-10-1	Front (2 pcs.)	1.6541	0.800	.0783
		TOG-10-2	Rear (2 pcs.)	1.6350	0.895	.0790
TOG-11** .005 und .010 und	Toyota - Balance Shaft Bearing Set	TOG-11-1	(4 pcs.)	1.2615	0.765	.0597
		TOG-11-2	(4 pcs.)	1.2615	0.765	.0597
		TOG-11-3	(4 pcs.)	1.2615	0.765	.0597
TOG-11A** .005 und .010 und	Toyota - Balance Shaft Bearing Set	TOG-11-1	(8 pcs.)	1.2615	0.765	.0597
		TOG-11-3	(4 pcs.)	1.2615	0.765	.0597
TOG-11C** .005 und .010 und	Toyota - Balance Shaft Bearing Kit (Combines TOG-11 & TOG-11A)	TOG-11-1	(8 pcs.)	1.2615	0.765	.0597
		TOG-11-2	(4 pcs.)	1.2615	0.765	.0597
		TOG-11-3	(4 pcs.)	1.2615	0.765	.0597
VO-2**	Chrysler Marine, Volvo - Balance Shaft Bearing Set	VO-2-1	1	1.9655	1.060	.0570
		VO-2-2	2	1.8081	1.025	.0570
		VO-2-3	3	1.5724	1.100	.0573
VO-3 .010 und	Chrysler Marine, Volvo - Cam Bearing Set	VO-2-1	1,2,3,4	1.9655	1.060	.0570
VOA-1*	Volvo - OHC Cam Bearing Set (Half Shell)	VHA-1-2(U)	1,2,3,4,5	1.2655	0.700	.0422
		VOA-1-1(L)	1,2,3,4,5	1.2655	0.700	.0422
VW-1	Volkswagen - Cam Bearing Set	VW-1-1	1	1.0831	0.787	.0490
		VW-1-2	2	1.0831	0.906	.0490
		VW-1-3(U)	3	1.0831	1.102	.0490
		VW-1-3(L)	3	1.0831	1.102	.0490
VWA-1*	Audi - OHC Cam Bearing Set (Half Shell)	VWA-1-1(U)	1	1.3439	0.830	.0422
		VWA-1-2(U)	2,3	1.2655	0.830	.0422
		VWA-1-4(U)	4	1.2655	0.630	.0422
		MZA-2-3(L)	1	1.3439	0.830	.0422
		VWA-1-5(L)	2,3	1.2655	0.700	.0422
		VWA-1-3(L)	4	1.2655	0.630	.0422
VWA-2* .010 und .020 und .030 und .040 und	Volkswagen - OHC Cam Bearing Set (Half Shell)	VWA-2-2(U)	1,2,3,4,5	1.1085	0.680	.0422
		VWA-2-1(L)	1,2,3,4,5	1.1085	0.680	.0422
VWG-1**	Audi, Chrysler, Volkswagen - Auxiliary Shaft Bearing Set	VWG-1-1	1	1.8115	0.585	.0590
		VWG-1-2	2	1.7721	0.585	.0590
WA-3	Case Tractor, IHC, Military Standard, Waukesha - Cam Bearing Set	WA-3-1	1	2.2540	1.125	.0643
		WA-3-2	2	2.0040	1.312	.0645
		WA-3-3	3	1.6290	1.500	.0645

*Denotes (OHC) Repair Bearing, Check "Aluminum Overhead Cam Accessories" Section For Tool Information

**Denotes Auxiliary / Balance Shaft Bearing

"und" Denotes Undersized ID

BEARING SET CONTENTS

SET NO.	ENGINE MFG. / DESCRIPTION	CONTENTS	POSITION	HOUSING BORE	LENGTH	MAX WALL
WA-4	Military Standard, Oliver Tractor, Waukesha - Cam Bearing Set	WA-1-1	1	1.8750	1.000	.0617
WA-7	Oliver Tractor, Waukesha - Cam Bearing Set	WA-1-1	1,2,3,4	1.8750	1.000	.0617
WA-8	Waukesha - Cam Bearing Set	WA-8-1	1	2.1250	1.067	.0605
		WA-8-2	2,3,4	2.1250	0.880	.0605
WA-9	Waukesha - Cam Bearing Set	WA-9-1	1	2.8750	1.880	.0645
		WA-9-2	2,3	2.8750	1.505	.0645
		WA-9-3	4	2.1870	2.255	.0643
WA-10	Waukesha - Cam Bearing Set	WA-2-1	1,2,3,4	2.2500	1.250	.0614
WA-11	Waukesha - Cam Bearing Set	WA-11-1	1,2,3,4	2.6250	1.500	.0618
WA-12	Waukesha - Cam Bearing Set w/Expansion Plug (DP-22-P)	WA-8-1	1	2.1250	1.067	.0605
		WA-8-2	2,3	2.1250	0.880	.0605
		DP-22-P	(Expansion Plug)			

*Denotes (OHC) Repair Bearing, Check "Aluminum Overhead Cam Accessories" Section For Tool Information

**Denotes Auxiliary / Balance Shaft Bearing

"und" Denotes Undersized ID

BEARING COMPONENT LISTING

CONTENTS	IN SET(S)	HOUSING BORE	LENGTH	MAX WALL
351HP-1	351HP, 351RHP	2.2040	0.660	.0602
351HP-1R1	351HP-R1	2.2140	0.660	.0652
351HP-1T	351HPT, 351RHPT	2.2040	0.660	.0602
351HP-2	351HP	2.2040	0.660	.0677
351HP-2R1	351HP-R1	2.2140	0.660	.0727
351HP-2T	351HPT	2.2040	0.660	.0677
351HP-3	351HP	2.2040	0.660	.0752
351HP-3R1	351HP-R1	2.2140	0.660	.0802
351HP-3T	351HPT	2.2040	0.660	.0752
351HP-4	351HP	2.2040	0.660	.0827
351HP-4R1	351HP-R1	2.2140	0.660	.0877
351HP-4T	351HPT	2.2040	0.660	.0827
351HP-5	351HP	2.2040	0.660	.0902
351HP-5R1	351HP-R1	2.2140	0.660	.0952
351HP-5T	351HPT	2.2040	0.660	.0902
351-HPB-1R1T	SBF-1R1T	2.2140	0.660	.0652
351-HPB-1T	SBF-1T	2.2040	0.660	.0602
351-HPB-2R1T	SBF-1R1T	2.2140	0.660	.0727
351-HPB-2T	SBF-1T	2.2040	0.660	.0677
351-HPB-3R1T	SBF-1R1T	2.2140	0.660	.0802
351-HPB-3T	SBF-1T	2.2040	0.660	.0752
351-HPB-4R1T	SBF-1R1T	2.2140	0.660	.0877
351-HPB-4T	SBF-1T	2.2040	0.660	.0827
351-HPB-5R1T	SBF-1R1T	2.2140	0.660	.0952
351-HPB-5T	SBF-1T	2.2040	0.660	.0902
A-1-1	A-1, A-6	1.8805	1.125	.0642
A-2-1	A-2	2.0055	1.308	.0643
A-3-1	A-3, A-4, A-5	2.2595	1.385	.0630
A-3-2	A-3, A-4, A-5	2.2595	1.000	.0630
A-6-1	A-6	1.8805	1.125	.0642
AGB-14-1	CHG-14**	1.8895	0.984	.0586
AGB-29-1	FG-29**	1.7750	0.500	.0606
AGB-34-1	FG-34**	1.7975	0.500	.0714
AGB-34-2	FG-34**	1.7775	0.500	.0614
AGB-51-1	F-38, F-38X, FG-51**	2.1920	0.635	.0694
B-4-1	B-8	1.9165	0.750	.0643
B-4-3	B-6, B-8, B-11	1.8565	0.750	.0643
B-4-4	B-6, B-8, B-11	1.8265	0.750	.0643
B-4-5	B-6, B-8, B-11	1.7965	0.750	.0643
B-6-1	B-6, B-8, B-11	1.8865	0.750	.0642
B-9-2	B-9, B-12, B-12B, B-13	1.9165	0.620	.0642
B-9-2R	B-13R	1.9625	0.620	.0642
B-11-1	B-9, B-11, B-12	1.9165	0.750	.0642
B-11-1B	B-12B	1.9165	0.750	.0642
B-13-1	B-13	1.9365	0.750	.0743
B-13-1R	B-13R	1.9625	0.750	.0743
B-14-1	B-14	1.9965	0.745	.0741
B-14-1R	B-14R	2.0207	0.745	.0741
B-14-2	B-14	1.9765	0.630	.0641
B-14-2R	B-14R	2.0207	0.630	.0641
BL-1-1	BL-1	1.7960	1.125	.0644
BL-1-2	BL-1	1.7539	0.755	.0644
BL-1-3	BL-1	1.5039	0.533	.0644
BMA-1-1	BMA-1*, BMA-2*, BMA-3*	1.8918	0.800	.0403
BMA-1-2	BMA-1*, BMA-2*, BMA-3*	1.8524	0.800	.0403

*Denotes (OHC) Repair Bearing, Check "Aluminum Overhead Cam Accessories" Section For Tool Information

**Denotes Auxiliary / Balance Shaft Bearing

"und" Denotes Undersized ID

BEARING COMPONENT LISTING

CONTENTS	IN SET(S)	HOUSING BORE	LENGTH	MAX WALL
BMA-1-3	BMA-1*, BMA-2*, BMA-3*	1.8131	0.800	.0403
BMA-1-4	BMA-1*	1.4587	1.390	.0403
BMA-1-5	BMA-3*	1.8918	0.800	.0500
BMA-1-6	BMA-3*	1.8524	0.995	.0500
BMA-1-7	BMA-3*	1.8131	0.800	.0500
BMA-1-8	BMA-4*	1.7741	1.115	.0403
BMA-1-9	BMA-4*	1.7340	1.085	.0400
BMA-1-10	BMA-2*, BMA-3*	1.5772	0.800	.0403
BMA-4-3	BMA-4*	1.4587	1.000	.0398
BP-9-2	BP-9, BP-13	1.9165	0.620	.0642
BP-9-2T	BP-9T, BP-13T	1.9165	0.620	.0642
BP-11-1	BP-9	1.9165	0.750	.0642
BP-11-1T	BP-9T	1.9165	0.750	.0642
BP-13-1	BP-13	1.9365	0.750	.0743
BP-13-1T	BP-13T	1.9365	0.750	.0743
BU-1-1	BU-2	2.1245	1.125	.0615
BU-1-2	BU-2	2.1245	0.875	.0615
BU-1-3	BU-2	1.3745	1.000	.0615
C-2-1	C-2	1.8797	0.750	.0641
C-2-2	C-2	1.5682	0.875	.0642
C-3-1	C-3	1.8797	0.620	.0637
C-4-1	C-4, C-4A	2.1687	0.591	.0652
C-4-2	C-4, C-4A	2.1487	0.591	.0652
C-4-3	C-4, C-4A	2.1287	0.591	.0652
C-4-4	C-4, C-4A	2.1087	0.591	.0652
C-4-5	C-4	2.0887	0.591	.0652
C-4-5A	C-4A	2.0887	0.685	.0652
CA-3-1	CA-3	1.8805	1.312	.0642
CA-3-2	CA-3	1.8805	0.718	.0642
CA-3-3	CA-3	1.8805	1.187	.0642
CA-4-1	CA-4, CA-5, CA-8, CA-9	1.8805	1.218	.0643
CA-4-2	CA-4, CA-5, CA-8, CA-9	1.8805	0.495	.0642
CA-5-3	CA-5	1.8805	0.718	.0642
CA-6-1	CA-6, CA-7	2.3745	1.656	.0625
CA-6-2	CA-6, CA-7	2.3745	1.437	.0625
CA-6-3	CA-6, CA-7	2.3745	1.156	.0625
CA-9-1	CA-9	1.8805	0.970	.0640
CAT-1-2	CAT-2	2.6525	0.755	.0750
CAT-2-1	CAT-6, CAT-7	2.5630	1.125	.1243
CAT-2-2	CAT-6, CAT-7	2.5630	1.004	.1243
CAT-2-3	CAT-2-3	2.2776	1.185	.0946
CAT-2-4	CAT-2-4	2.2776	2.000	.0946
CAT-2-5	CAT-2-5	2.1880	1.180	.1052
CAT-2-6	CAT-2-6	2.1880	2.000	.1052
CAT-3-1	CAT-3-1	2.8745	1.185	.1258
CAT-3-2	CAT-3-2	2.8745	1.995	.1256
CAT-5-0	CAT-5, CAT-8	2.7559	1.340	.0945
CAT-5-1	CAT-5, CAT-8	2.7165	0.750	.0748
CH-2-1	CH-2	2.1599	1.125	.0644
CH-2-2	CH-2	2.0975	0.937	.0644
CH-2-3	CH-2	2.0350	0.937	.0644
CH-2-4	CH-2	1.9725	0.937	.0644
CH-3-1	CH-3	2.2850	1.125	.0641
CH-3-2	CH-3	2.2225	0.937	.0641
CH-3-3	CH-3	2.1600	0.937	.0641

*Denotes (OHC) Repair Bearing, Check "Aluminum Overhead Cam Accessories" Section For Tool Information

**Denotes Auxiliary / Balance Shaft Bearing

"und" Denotes Undersized ID

BEARING COMPONENT LISTING

CONTENTS	IN SET(S)	HOUSING BORE	LENGTH	MAX WALL
CH-3-4	CH-3	2.0975	0.937	.0642
CH-4-1	CH-4, CH-8, CH-17, CH-17G, CH-21, CH-21G	2.0200	0.740	.0744
CH-4-1S	CH-4A	2.0300	0.740	.0795
CH-4-1W	CH-8W, CH-17X, CH-21X	2.0200	0.740	.0749
CH-4-2	CH-4, CH-8, CH-17, CH-17G, CH-21, CH-21G	2.0100	0.740	.0694
CH-4-2W	CH-8W, CH-17X, CH-21X	2.0100	0.740	.0699
CH-4-3	CH-4, CH-8, CH-17, CH-17G, CH-21, CH-21G, RDC-1	2.0000	0.740	.0644
CH-4-3W	CH-8W, CH-17X, CH-21X	2.0000	0.740	.0649
CH-4-4	CH-4	2.0100	0.940	.0694
CH-5-1	CH-5	2.0200	0.860	.0744
CH-5-2	CH-5, CH-6, CH-7	2.0100	0.860	.0694
CH-5-3	CH-5, CH-6, CH-7, CH-11, CH-16, RDC-1	2.0000	0.860	.0644
CH-5-3B	CH-11B	2.0000	0.860	.0644
CH-5-3W	CH-16W	2.0000	0.860	.0649
CH-5-4	CH-5	2.0100	0.940	.0694
CH-9-4	CH-9A	2.1300	0.980	.0894
CH-10-1	CH-10, CH-23	2.3270	0.630	.0790
CH-10-2	CH-10	2.3171	0.630	.0740
CH-10-3	CH-10, CH-23, GM-9	2.3088	0.630	.0700
CH-12-1	CH-9A, CH-12	2.1400	0.860	.0941
CH-12-1B	CH-12B	2.1400	0.860	.0941
CH-12-2	CH-9A, CH-12	2.1300	0.980	.0891
CH-12-2B	CH-12B	2.1300	0.980	.0891
CH-12-3	CH-9A, CH-12, GM-12	2.1200	0.980	.0841
CH-12-3B	CH-12B	2.1200	0.980	.0841
CH-12-3LT	GMP-12LT	2.1200	0.980	.0841
CH-13-1	CH-13	2.4125	0.680	.0643
CH-13-2	CH-13	2.4125	0.680	.0643
CH-18-1A	CH-18, CH-18A	2.0100	0.625	.0691
CH-18-1R3	CH-18RS	2.0400	0.625	.0848
CH-18-1R8	CH-18R8	2.0900	0.625	.1091
CH-18-2	CH-18, CH-19, CHG-22**	1.9995	0.630	.0640
CH-18-2A	CH-18A	1.9995	0.720	.0640
CH-18-2R2	CH-18RS	2.0300	0.720	.0798
CH-18-2R8	CH-18R8	2.0800	0.720	.1040
CH-18-2X2	CH-19X2	1.9995	0.630	.0650
CH-18-4	CH-18, CH-18A, CH-19, CHG-22**	2.0095	0.625	.0691
CH-18-4R4	CH-18RS	2.0400	0.625	.0847
CH-18-4R8	CH-18R8	2.0900	0.625	.1091
CH-18-4X2	CH-19X2	2.0095	0.625	.0701
CH-19-1	CH-19	2.0199	0.625	.0741
CH-19-1X2	CH-19X2	2.0199	0.625	.0751
CH-20-1	CH-20	2.0000	0.710	.0644
CH-23-1	CH-23	2.3470	0.630	.0890
CH-24-1	CH-24	2.1766	0.905	.0747
CH-24-2	CH-24	2.1565	0.630	.0646
CH-24-3	CH-24	2.1766	0.620	.0747
CH-25-1	CH-25	2.3482	0.775	.0890
CH-25-2	CH-25	2.3285	0.775	.0799
CH-25-3	CH-25, GM-25	2.3088	0.775	.0700
CHG-15-1	CH-17G, CH-21G, CHG-15A**	1.8740	0.835	.1860
CHG-22-1	CHG-22**	2.0100	1.172	.0691
CHG-23-1	CHG-23**	1.6253	0.865	.0808
CHG-23-2	CHG-23**	1.5969	0.865	.0808
CHG-23-3	CHG-23**	1.8672	0.862	.0808

*Denotes (OHC) Repair Bearing, Check "Aluminum Overhead Cam Accessories" Section For Tool Information

**Denotes Auxiliary / Balance Shaft Bearing

"und" Denotes Undersized ID

BEARING COMPONENT LISTING

CONTENTS	IN SET(S)	HOUSING BORE	LENGTH	MAX WALL
CHG-23-4	CHG-23**	1.8955	0.862	.0808
CHG-24-1	CHG-24**	1.6050	1.020	.0786
CHP-4-1	CHP-4, CHP-8, CHP-17, CHP-21	2.0200	0.740	.0744
CHP-4-1T	CHP-4T, CHP-8T, CHP-17T, CHP-21T	2.0200	0.740	.0744
CHP-4-2	CHP-4, CHP-8, CHP-17, CHP-21	2.0100	0.740	.0694
CHP-4-2T	CHP-4T, CHP-8T, CHP-17T, CHP-21T	2.0100	0.740	.0694
CHP-4-3	CHP-4, CHP-8, CHP-17, CHP-21, GMP-8, RDCP-1	2.0000	0.740	.0644
CHP-4-3T	CHP-4T, CHP-8T, CHP-17T, CHP-21T, GMP-8T, RDCP-1T	2.0000	0.740	.0644
CHP-4-4	CHP-4	2.0100	0.940	.0694
CHP-4-4T	CHP-4T	2.0100	0.940	.0694
CHP-4-11	CHP-8R1	2.0300	0.740	.0794
CHP-4-11T	CHP-8R1T	2.0300	0.740	.0794
CHP-4-12	CHP-8R2	2.0400	0.740	.0844
CHP-4-12T	CHP-8R2T	2.0400	0.740	.0844
CHP-4-13	CHP-8R3	2.0500	0.740	.0894
CHP-4-13T	CHP-8R3T	2.0500	0.740	.0894
CHP-4-14	CHP-8R4	2.0600	0.740	.0944
CHP-4-14T	CHP-8R4T	2.0600	0.740	.0944
CHP-5-3	RDCP-1	2.0000	0.860	.0644
CHP-5-3T	RDCP-1T	2.0000	0.860	.0644
CHP-10-1	CHP-10, CHP-23	2.3270	0.630	.0790
CHP-10-1T	CHP-10T, CHP-23T	2.3270	0.630	.0790
CHP-10-2	CHP-10	2.3171	0.630	.0740
CHP-10-2T	CHP-10T	2.3171	0.630	.0740
CHP-10-3	CHP-10, CHP-23, GMP-9	2.3088	0.630	.0700
CHP-10-3T	CHP-10T, CHP-23T, GMP-9T	2.3088	0.630	.0700
CHP-12-1	CHP-12	2.1400	0.860	.0941
CHP-12-1T	CHP-12T	2.1400	0.860	.0941
CHP-12-2	CHP-12	2.1300	0.980	.0891
CHP-12-2T	CHP-12T	2.1300	0.980	.0891
CHP-12-3	CHP-12, GMP-12	2.1200	0.980	.0841
CHP-12-3T	CHP-12T, GMP-12T	2.1200	0.980	.0841
CHP-12-11	CHP-12R1	2.1500	0.860	.0991
CHP-12-12	CHP-12R2	2.1600	0.860	.1041
CHP-12-21	CHP-12R1	2.1500	0.980	.0991
CHP-12-22	CHP-12R2	2.1600	0.980	.1041
CHP-23-1	CHP-23	2.3470	0.630	.0890
CHP-23-1T	CHP-23T	2.3470	0.630	.0890
CHP-25-1	CHP-25	2.3482	0.775	.0890
CHP-25-2	CHP-25	2.3285	0.775	.0799
CHP-25-3	CHP-25, GMP-25	2.3088	0.775	.0700
CHP-25-1T	CHP-25T	2.3482	0.775	.0890
CHP-25-2T	CHP-25T	2.3285	0.775	.0799
CHP-25-3T	CHP-25T, GMP-25T	2.3088	0.775	.0700
CO-7-1	CO-7	2.3743	1.094	.0940
CO-7-2	CO-7	2.3120	1.000	.0940
CO-7-3	CO-7	2.2495	1.000	.0940
CO-7-4	CO-7	1.9370	1.250	.0940
CO-9-1	CO-9	1.9375	1.323	.0626
CO-9-2	CO-9	1.8750	0.573	.0626
CO-9-3	CO-9	1.8125	1.135	.0626
CU-1-1	CU-5A, CU-10	2.1290	2.250	.0644
CU-5-2A	CU-5A, CU-10	2.1250	1.685	.0644
CU-8-1	CU-9	2.6870	1.685	.0939
CU-9-1	CU-9	2.6870	1.685	.0939

*Denotes (OHC) Repair Bearing, Check "Aluminum Overhead Cam Accessories" Section For Tool Information

**Denotes Auxiliary / Balance Shaft Bearing

"und" Denotes Undersized ID

BEARING COMPONENT LISTING

CONTENTS	IN SET(S)	HOUSING BORE	LENGTH	MAX WALL
CU-9-2	CU-9	2.6870	2.185	.0939
CU-11-1	CU-11, CU-11A	2.1870	1.905	.0932
CU-11-2	CU-11, CU-11A	2.1870	0.905	.0932
CU-12-1	CU-12	2.2535	1.005	.0620
CU-13-1	CU-13	2.6870	1.810	.0937
CU-13-2	CU-13	2.6870	1.070	.0937
CU-14-1	CU-14	2.3323	1.005	.1010
DA-1-1	DA-1	1.8509	0.930	.0625
DA-1-2	DA-1	1.8312	0.555	.0625
DA-1-3	DA-1	1.8115	0.555	.0625
DA-1-4	DA-1	1.7918	0.555	.0625
DA-1-5	DA-1	1.7495	0.555	.0625
DA-2-1	DA-2	1.9155	1.455	.0624
DA-2-2	DA-2	1.8555	1.070	.0624
DA-2-3	DA-2	1.7495	0.812	.0624
DA-3-1	DA-3A, DA-5	1.9155	0.945	.0625
DA-3-2	DA-3A, DA-5	1.8555	0.865	.0625
DA-3-3A	DA-3A, DA-5	1.7495	0.947	.0625
DE-1-1	DE-1	2.2505	1.545	.0925
DE-2-1	DE-2, DE-2A, DE-5, DE-7	2.3755	1.505	.0943
DE-2-1R1	DE-2R1, DE-2AR1, DE-5R1	2.3855	1.505	.0993
DE-2-2	DE-2, DE-2A, DE-5, DE-7	2.3655	1.505	.0900
DE-2-2R1	DE-2R1, DE-2AR1, DE-5R1	2.3755	1.505	.0943
DE-2-3	DE-7	2.3555	1.505	.0844
DE-4-1	DE-4	2.7216	0.705	.0774
DT-1-1	DT-1	2.0000	0.740	.0644
DT-1-1T	DT-1T	2.0000	0.740	.0644
DT-1-11T	DT-1TR1	2.0100	0.740	.0694
F-1-1	F-1	1.9280	1.600	.0648
F-1-2	F-1	1.9280	1.312	.0648
F-7-2	F-7	2.0580	0.875	.0649
F-8-1	F-11, F-12	2.2500	0.875	.0618
F-9-1	F-9A, F-9B	2.0580	0.875	.0648
F-9-2B	F-9B	2.0580	0.620	.0648
F-9-3	F-9A	2.0580	0.620	.0648
F-11-2	F-11, F-12	2.2500	0.755	.0618
F-12-1	F-12	2.6000	0.755	.0617
F-14-5	F-19	2.3880	0.710	.0610
F-15-2	F-33	2.2950	0.620	.0841
F-15-3	F-33	2.2800	0.620	.0766
F-15-4	F-33	2.2650	0.620	.0691
F-15-5	F-33	2.2500	0.560	.0616
F-16-1	F-16	2.6025	0.670	.0629
F-16-2	F-16	2.4985	0.670	.0629
F-17-2	F-32	1.9635	0.720	.0757
F-17-3	F-32	1.9485	0.720	.0682
F-17-4	F-32	1.9335	0.720	.0607
F-18-1	F-18	2.2040	0.660	.0602
F-18-2	F-18, F-26	2.1890	0.660	.0602
F-18-3	F-18, F-26	2.1740	0.660	.0602
F-18-4	F-18, F-26	2.1590	0.660	.0602
F-18-5	F-18, F-26	2.1440	0.660	.0602
F-19-1	F-19	2.4480	0.710	.0609
F-19-2	F-19	2.4330	0.710	.0609
F-19-3	F-19	2.4180	0.710	.0609

*Denotes (OHC) Repair Bearing, Check "Aluminum Overhead Cam Accessories" Section For Tool Information

**Denotes Auxiliary / Balance Shaft Bearing

"und" Denotes Undersized ID

BEARING COMPONENT LISTING

CONTENTS	IN SET(S)	HOUSING BORE	LENGTH	MAX WALL
F-19-4	F-19	2.4030	0.710	.0609
F-22-1	F-7, F-22	2.0580	0.875	.0649
F-23-1A	F-23A	2.1445	0.860	.0624
F-23-1B	F-23B, F-49B	2.1445	0.860	.0624
F-24-2	F-24	2.2950	0.620	.0844
F-24-3	F-24	2.2800	0.620	.0769
F-24-4	F-24	2.2650	0.620	.0694
F-24-5	F-24	2.2500	0.560	.0619
F-25-1	F-25	2.1365	1.000	.0624
F-26-1	F-26	2.2500	0.660	.0616
F-28-1	F-28	1.6890	0.790	.0633
F-28-2	F-28	1.6890	0.685	.0633
F-28-3	F-28	1.6890	0.790	.0633
F-29-1	F-29	1.7755	0.785	.0600
F-29-2	F-29	1.8785	0.665	.0600
F-29-3A	F-29	1.8935	0.625	.0600
F-30-1	F-30	2.2500	0.580	.0618
F-30-1R1	F-30R1	2.2600	0.580	.0668
F-30-1R2	F-30R2	2.2700	0.580	.0718
F-30-1S	F-57	2.2650	0.625	.0694
F-31-1	F-31	1.7734	0.775	.0604
F-31-2	F-31	1.7585	0.700	.0604
F-31-3	F-31	1.7435	0.700	.0604
F-31-4	F-31, F-42	1.7285	0.595	.0604
F-32-1	F-32	1.9785	0.720	.0832
F-33-1	F-24, F-33	2.3100	0.620	.0912
F-34-1	F-34	1.9011	0.693	.0638
F-34-1B	F-34B	1.9011	0.693	.0638
F-34-1S	F-34S	1.9203	0.693	.0738
F-41-1	F-41*	1.9299	0.949	.0794
F-41-2	F-41*	1.9299	0.714	.0794
F-42-1	F-42	1.7585	0.775	.0604
F-42-2	F-42	1.7435	0.700	.0604
F-43-1	F-43, F-44, F-55	2.5345	0.765	.0708
F-45-1	F-45	2.1920	0.635	.0694
F-45-2	F-45	2.1770	0.555	.0619
F-46-1	F-46	2.2047	0.723	.0973
F-46-2	F-46	2.1890	0.723	.0894
F-46-3	F-46	2.2047	0.503	.0973
F-47-1	F-47, F-47B	1.8521	0.780	.0605
F-47-2	F-47	1.8371	0.700	.0605
F-47-2B	F-47B	1.8371	0.700	.0605
F-47-3	F-47	1.8222	0.700	.0605
F-47-3B	F-47B	1.8222	0.700	.0605
F-47-4	F-47, F-47B	1.8072	0.595	.0605
F-48-1	F-48, F-48A	2.1536	0.955	.0719
F-48-2	F-48, F-48A	2.1339	0.537	.0620
F-48-4	F-48	2.1536	0.537	.0719
F-48-4A	F-48A	2.1536	0.537	.0719
F-49-1	F-49	2.1590	0.860	.0695
F-49-1B	F-49B	2.1590	0.860	.0695
F-49-2	F-49	2.1445	0.860	.0624
F-50-1	F-50, F-50A	2.0776	0.775	.0617
F-50-2	F-50, F-50A	2.0626	0.700	.0614
F-50-3	F-50, F-50A	2.0476	0.700	.0614

*Denotes (OHC) Repair Bearing, Check "Aluminum Overhead Cam Accessories" Section For Tool Information

**Denotes Auxiliary / Balance Shaft Bearing

"und" Denotes Undersized ID

BEARING COMPONENT LISTING

CONTENTS	IN SET(S)	HOUSING BORE	LENGTH	MAX WALL
F-50-4	F-50	2.0327	0.585	.0615
F-50-4A	F-50A	2.0327	0.825	.0615
F-51-2	F-38, F-52	2.1770	0.555	.0619
F-51-2X	F-38X	2.1770	0.595	.0613
F-52-1	F-38, F-52	2.1920	0.635	.0694
F-52-1X	F-38X	2.1920	0.635	.0688
FA-1-1	FA-1*	1.9035	0.925	.0503
FA-1-2	FA-1*	1.8985	0.925	.0478
FA-1-3	FA-1*	1.8935	0.925	.0453
FA-1-4	FA-1*	1.8885	0.925	.0428
FA-1-5	FA-1*	1.8835	0.925	.0403
FA-2-1	FA-2*	1.8435	0.845	.0403
FA-2-2	FA-2*	1.8535	0.845	.0403
FA-2-3	FA-2*	1.8635	0.845	.0403
FA-2-4	FA-2*	1.8735	0.845	.0403
FA-2-5	FA-2*	1.8835	0.845	.0403
FA-3-1(L)	FA-3*, FA-14L*, FA-14R*	1.1469	0.570	.0422
FA-3-1S(U)	FA-14L*	1.1469	0.570	.0422
FA-3-2(L)	FA-4*	1.1469	0.570	.0422
FA-3-2(U)	FA-3*, FA-14L*, FA-14R*	1.1469	0.570	.0422
FA-4-1(L)	FA-4*, FA-5*	1.1469	0.455	.0420
FA-4-2(L)	FA-4*, FA-5*	1.1469	0.455	.0420
FA-4-3(U)	FA-4*, FA-5*	1.1469	0.570	.0420
FA-4-4(U)	FA-4*, FA-5*	1.1469	0.455	.0420
FA-5-1(L)	FA-5*	1.1469	0.570	.0422
FA-6-1(L)	FA-6*	1.1875	0.960	.0422
FA-6-2(U)	FA-6*	1.1875	0.960	.0422
FA-6-3(L)	FA-6*	1.1875	0.680	.0422
FA-6-4(U)	FA-6*	1.1875	0.680	.0422
FA-13-1(L)	FA-13L*	1.2132	1.215	.0422
FA-13-2(U)	FA-13L*, FA-13R*	1.2132	1.215	.0422
FA-13-3(L)	FA-13L*, FA-13R*	1.2132	0.700	.0422
FA-13-4(U)	FA-13L*, FA-13R*	1.2132	0.700	.0422
FA-13-5(L)	FA-13R*	1.2132	1.215	.0422
FG-1-1	FG-1-1**	2.1430	0.815	.0701
FG-53-1	FG-53**	1.8522	1.142	.0610
FG-53-2	FG-53**	1.8072	0.905	.0610
FP-01-1	FP-01	2.3095	0.760	.0912
FP-01-1R1	FP-01R1	2.3200	0.760	.0962
FP-01-2	FP-01	2.3095	0.760	.0912
FP-01-2R1	FP-01R1	2.3200	0.760	.0962
FP-01-4	FP-01	2.3095	0.760	.0912
FP-01-4R1	FP-01R1	2.3200	0.760	.0962
FP-15-2	FP-33	2.2950	0.620	.0841
FP-15-2T	FP-33T	2.2950	0.620	.0841
FP-15-3	FP-33	2.2800	0.620	.0766
FP-15-3T	FP-33T	2.2800	0.620	.0766
FP-15-4	FP-33	2.2650	0.620	.0691
FP-15-4T	FP-33T	2.2650	0.620	.0691
FP-15-5	FP-33	2.2500	0.560	.0616
FP-15-5T	FP-33T	2.2500	0.560	.0616
FP-18-1	FP-18	2.2040	0.660	.0602
FP-18-1T	FP-18T	2.2040	0.660	.0602
FP-18-2	FP-18, FP-26	2.1890	0.660	.0602
FP-18-2T	FP-18T, FP-26T	2.1890	0.660	.0602

*Denotes (OHC) Repair Bearing, Check "Aluminum Overhead Cam Accessories" Section For Tool Information

**Denotes Auxiliary / Balance Shaft Bearing

"und" Denotes Undersized ID

BEARING COMPONENT LISTING

CONTENTS	IN SET(S)	HOUSING BORE	LENGTH	MAX WALL
FP-18-3	FP-18, FP-26	2.1740	0.660	.0602
FP-18-3T	FP-18T, FP-26T	2.1740	0.660	.0602
FP-18-4	FP-18, FP-26	2.1590	0.660	.0602
FP-18-4T	FP-18T, FP-26T	2.1590	0.660	.0602
FP-18-5	FP-18, FP-26	2.1440	0.660	.0602
FP-18-5T	FP-18T, FP-26T	2.1440	0.660	.0602
FP-26-1	FP-26	2.2500	0.660	.0616
FP-26-1T	FP-26T, FP-30AT	2.2500	0.660	.0616
FP-30-1	FP-30	2.2500	0.580	.0618
FP-30-1R	FP-30R	2.2550	0.580	.0645
FP-30-1T	FP-30T	2.2500	0.580	.0618
FP-33-1	FP-33	1.7734	0.775	.0604
FP-33-1T	FP-33T	1.7734	0.775	.0604
GM-5-1	GM-5	2.1875	1.680	.0641
GM-5-2	GM-5	2.1562	0.880	.0641
GM-5-3	GM-5	2.1250	0.880	.0641
GM-5-4	GM-5	1.9725	1.150	.0641
GM-7-1	GM-7	2.3280	0.895	.0798
GM-7-1R2	GM-7R2	2.3480	0.895	.0898
GM-7-2	GM-7	2.3190	0.775	.0753
GM-7-2R2	GM-7R2	2.3480	0.775	.0898
GM-7-3	GM-7	2.3090	0.775	.0703
GM-7-4	GM-7	2.2990	0.775	.0653
GM-7-5	GM-7, GM-7R2	2.1420	0.775	.0655
GM-8-1	GM-8	2.5598	1.120	.0790
GM-8-2	GM-8	2.5598	0.705	.0790
GM2125-1	GMP-3	2.2500	0.855	.0620
GM2125-1T	GMP-3T	2.2500	0.855	.0620
GM2125-4	GMP-3	2.2500	0.980	.0620
GM2125-4T	GMP-3T	2.2500	0.980	.0620
GMA-1-1	GMA-1*	1.8607	0.817	.0550
GMA-1-2	GMA-1*	1.8607	0.661	.0550
GMA-2-1(L)	GMA-2*	1.2655	0.665	.0617
GMA-2-1(U)	GMA-2*	1.2655	0.665	.0617
GMA-2-2(L)	GMA-2*	1.2655	0.665	.0617
GMA-2-3(U)	GMA-2*	1.2655	0.665	.0617
GMP-1-1	GMP-1	2.1200	0.755	.0841
GMP-1-1T	GMP-1T	2.1200	0.755	.0841
GMP-2-1T	GMP-2T	2.1200	0.755	.0841
GMP-55-1	GMP-55	2.2820	0.785	.0569
GMP-55-1T	GMP-55T	2.2820	0.785	.0569
H-5-1	H-5	2.1560	0.750	.0620
H-5-2	H-5	2.1460	0.750	.0620
H-5-3	H-5	2.1360	0.750	.0620
H-5-4	H-5	2.1260	0.750	.0620
H-5-5	H-5	1.6260	1.060	.0620
HA-1-1(U)	HA-1*	1.2655	0.700	.0622
HA-1-2(U)	HA-2*	1.2655	0.830	.0618
HA-1-3(L)	HA-2*	1.2655	0.830	.0618
HA-1-4(U)	HA-2*	1.2655	0.700	.0622
HA-1-4A(U)	HA-2*	1.2655	0.700	.0622
HA-1-5(L)	HA-1*, HA-2*	1.2655	0.700	.0622
HA-1-5(U)	HA-2*	1.2655	0.700	.0622
HA-3-1(L)	HA-3*	1.1875	0.735	.0422
HA-3-2(U)	HA-3*	1.1875	0.735	.0422

*Denotes (OHC) Repair Bearing, Check "Aluminum Overhead Cam Accessories" Section For Tool Information

**Denotes Auxiliary / Balance Shaft Bearing

"und" Denotes Undersized ID

BEARING COMPONENT LISTING

CONTENTS	IN SET(S)	HOUSING BORE	LENGTH	MAX WALL
HA-3-3(L)	HA-3*, HA-5*	1.1875	0.535	.0422
HA-3-4(U)	HA-3*, HA-5*	1.1875	0.535	.0422
HA-4-1(U)	HA-4*	1.2655	1.242	.0618
HA-4-2(L)	HA-4*	1.2655	1.242	.0618
HA-4-3(U)	HA-4*	1.2655	0.530	.0618
HA-4-4(L)	HA-4*	1.2655	0.530	.0618
HA-5-1(L)	HA-5*	1.2655	0.788	.0618
HA-5-2(U)	HA-5*	1.2655	0.788	.0618
HE-1-1	HE-1	2.1875	1.125	.0660
HE-1-2	HE-1, HE-7, HE-8	2.1875	0.812	.0660
HE-1-2A	HE-8A	2.1862	0.812	.0653
HE-5-1	HE-5	1.8753	1.020	.0617
HE-5-2	HE-5	1.8753	0.550	.0617
HE-7-1	HE-7, HE-8	2.1875	1.057	.0658
HE-7-1A	HE-8A	2.1862	1.057	.0653
HO-1-1	HO-1	1.8968	0.815	.0643
HO-2-1	HO-2, HO-2S	2.0300	0.785	.0694
HO-2-2	HO-2, HO-2S	2.0200	0.785	.0644
HO-2-3	HO-2, HO-2S	2.0100	0.785	.0694
HO-2-4	HO-2, HO-2S	2.0000	0.785	.0644
HO-2-5	HO-2	1.7108	0.785	.0644
HO-2-5S	HO-2S	1.7128	0.785	.0644
HO-3-1	HO-3	1.9730	1.000	.0637
HO-3-2	HO-3	1.9410	0.875	.0637
HO-3-3	HO-3	1.9100	0.875	.0637
HO-3-4	HO-3	1.3790	0.875	.0637
HOP-2-1	HOP-2S	2.0300	0.785	.0694
HOP-2-2	HOP-2S	2.0200	0.785	.0644
HOP-2-3	HOP-2S	2.0100	0.785	.0694
HOP-2-4	HOP-2S	2.0000	0.785	.0644
HOP-2-5S	HOP-2S	1.7128	0.785	.0644
HOP-2-1T	HOP-2ST	2.0300	0.785	.0694
HOP-2-2T	HOP-2ST	2.0200	0.785	.0644
HOP-2-3T	HOP-2ST	2.0100	0.785	.0694
HOP-2-4T	HOP-2ST	2.0000	0.785	.0644
HOP-2-5ST	HOP-2ST	1.7128	0.785	.0644
IN-2-3	IN-3	2.2008	1.062	.0645
IN-2-4	IN-3, IN-16	1.6313	1.530	.0645
IN-3A-1	IN-3, IN-12, IN-14	2.2408	1.125	.0647
IN-5-1	IN-5	2.3748	1.438	.0644
IN-5-2	IN-5	2.2493	1.469	.0642
IN-5-3	IN-5	1.9993	1.063	.0643
IN-8-2	IN-3, IN-12, IN-14, IN-16	2.2207	1.062	.0647
IN-8-3	IN-12, IN-14	2.2007	1.062	.0647
IN-8-4	IN-14	1.6313	1.312	.0645
IN-10-1A	IN-10A	2.4748	1.187	.0618
IN-10-2	IN-10A	2.4438	1.000	.0625
IN-10-3	IN-10A	2.4153	1.000	.0613
IN-10-4A	IN-10A	2.3748	1.000	.0618
IN-11-1	IN-11	2.2313	0.710	.0647
IN-11-2	IN-11	2.2213	0.645	.0647
IN-11-3	IN-11	2.2113	0.645	.0647
IN-11-4	IN-11	2.2013	0.645	.0647
IN-11-5	IN-11	2.1913	0.750	.0647
IN-15-1	IN-15	2.0618	1.000	.0643

*Denotes (OHC) Repair Bearing, Check "Aluminum Overhead Cam Accessories" Section For Tool Information

**Denotes Auxiliary / Balance Shaft Bearing

"und" Denotes Undersized ID

BEARING COMPONENT LISTING

CONTENTS	IN SET(S)	HOUSING BORE	LENGTH	MAX WALL
IN-15-2	IN-15	1.9368	1.375	.0643
IN-15-3	IN-15	1.4993	1.000	.0643
IN-16-1	IN-16	2.5610	1.125	.0645
IN-16-3	IN-16	2.2010	1.060	.0645
IN-17-1	IN-17	2.2313	0.785	.0647
IN-17-1S	IN-17R2	2.2513	0.785	.0768
IN-17-2	IN-17	2.2313	0.650	.0647
IN-17-2S	IN-17R2	2.2513	0.650	.0768
IN-18-1	IN-18	1.9430	1.095	.0645
IN-18-2	IN-18	1.7083	1.005	.0641
IN-18-3	IN-18	1.6303	0.790	.0641
IN-19-1	IN-19	2.5013	1.010	.1078
IN-19-2	IN-19	2.4813	0.709	.0980
IN-19-3	IN-19	2.4613	0.709	.0880
IN-19-4	IN-19	2.4413	0.710	.0780
IN-21-1	IN-21	2.5984	0.740	.0778
IZ-2-1	IZ-2	2.0479	0.984	.0790
IZ-2-2	IZ-2	2.0480	0.984	.0790
IZ-2-3	IZ-2	2.0480	0.984	.0790
IZ-3-1	IZ-3	2.0486	0.866	.0797
IZ-3-2	IZ-3	2.0486	0.866	.0797
IZ-3-3	IZ-3	2.0486	0.866	.0797
IZ-5-1	IZ-5	2.1274	0.984	.0797
IZ-5-2	IZ-5	2.1274	0.866	.0797
IZ-6-1	IZ-6, IZ-7, IZ-8	2.3637	0.787	.0785
IZ-6-2	IZ-6, IZ-7, IZ-8	2.3637	0.787	.0785
J-1-1	J-1	2.3165	1.125	.0645
JD-1-1	JD-1, JD-2	1.9280	1.181	.0579
JD-1-2	JD-1, JD-2	1.9280	0.938	.0579
JD-3-1	JD-3, JD-4	2.5000	1.000	.0614
JD-5-1	JD-5	1.9280	1.598	.0577
JD-5-2	JD-5	1.9280	1.220	.0577
JDG-7-1	JDG-7**	1.6250	1.090	.0608
K-1-1	CO-8, K-1	2.0000	0.875	.0628
K-1-2	CO-3, K-1	1.9375	0.937	.0630
K-1-3	CO-3, CO-8, K-1	1.8750	1.620	.0628
K-1-4	CO-3, CO-8, K-1	1.3748	1.156	.0628
LR-1-1	LR-1	1.9165	0.750	.0642
MA-3A-1	MA-6	2.6235	1.380	.1852
MA-5-1	MA-5, MA-6, MA-7	2.6235	1.385	.0910
MA-5-2	MA-5	2.6235	1.010	.0905
MA-5-3	MA-5, MA-6, MA-7, MA-8	2.6235	1.010	.0910
MA-5-4	MA-5	2.6235	1.380	.1853
MA-8-1	MA-8	2.6235	1.385	.0905
MA-11-1	MA-11	2.8735	1.000	.0908
MA-11-2	MA-11	2.8735	1.181	.0908
MAG-10-1	MAG-10**	2.3115	1.760	.1237
MAG-10-2	MAG-10**	2.2495	1.760	.1243
MAG-11-1	MAG-11**	2.3115	1.750	.1235
MIA-1-1(U)	MIA-1*, MIA-4*	1.4225	0.795	.0422
MIA-1-3(U)	MIA-1*	1.4225	0.795	.0422
MIA-1-4(L)	MIA-1*, MIA-4*	1.4225	0.795	.0422
MIA-1-5(U)	MIA-2*	1.4971	0.793	.0792
MIA-1-6(L)	MIA-2*	1.4971	0.793	.0792
MIA-1-7(U)	MIA-2*	1.4971	0.793	.0792

*Denotes (OHC) Repair Bearing, Check "Aluminum Overhead Cam Accessories" Section For Tool Information

**Denotes Auxiliary / Balance Shaft Bearing

"und" Denotes Undersized ID

BEARING COMPONENT LISTING

CONTENTS	IN SET(S)	HOUSING BORE	LENGTH	MAX WALL
MIA-1-8(U)	MIA-4*	1.4225	0.795	.0422
MIA-3-1	MIA-3*	1.8918	0.685	.0403
MIA-5-1(U)	MIA-5*	1.4225	0.793	.0422
MIA-5-2(U)	MIA-5*	1.4225	0.710	.0422
MIA-5-3(U)	MIA-5*	1.4225	0.760	.0422
MIA-5-5(L)	MIA-5*	1.4225	0.793	.0422
MIA-5-6(L)	MIA-5*	1.4225	0.710	.0422
MIA-5-7(L)	MIA-5*	1.4225	0.760	.0422
MIA-5-8(U)	MIA-5*	1.4225	0.980	.0422
MIA-5-9(L)	MIA-5*	1.4225	0.980	.0422
MIG-1-EL	MIG-2E**	1.8126	0.930	NA
MIG-2-1	MIG-2**	1.8126	0.785	.0587
MIG-2-1R	MIG-2-1R**	1.9855	0.788	.1450
MIG-2-2	MIG-2**	1.0240	0.703	.0589
MIG-2-EL	MIG-2E**	0.6330	0.875	NA
MIG-3-1	MIG-3**	1.7721	0.745	.0590
MIG-3-2	MIG-3**	1.7328	0.825	.0592
MZA-1-1	MZA-1*	1.7931	0.730	.0403
MZA-1-2	MZA-1*	1.7931	0.730	.0403
MZA-1-3	MZA-1*	1.7931	0.730	.0403
MZA-2-1(U)	MZA-2*	1.3439	0.700	.0422
MZA-2-2(L)	MZA-2*	1.3439	0.830	.0422
MZA-2-3(L)	VWA-1*	1.3439	0.830	.0422
MZA-2-3(U)	MZA-2*	1.3439	0.830	.0422
MZA-4-1(U)	MZA-4*	1.2655	0.700	.0422
MZG-3-1	MZG-3**	1.8114	0.910	.0781
MZG-3-2	MZG-3**	1.7326	1.030	.0780
MZG-3-3	MZG-3**	0.9453	0.635	.0585
N-5-2	N-6	1.9370	0.780	.0647
N-5-3	N-6	1.9270	0.780	.0647
N-5-4	N-6	1.9170	0.810	.0647
N-6-1	N-6	1.9470	0.940	.0647
N-7-1	N-7, N-7B	2.1560	0.690	.0620
N-7-1X001	N-7BW	2.1560	0.690	.0625
N-7-2	N-7, N-10	2.1460	0.690	.0620
N-7-2B	N-7B	2.1460	0.690	.0620
N-7-2BX001	N-7BW	2.1460	0.690	.0625
N-7-3	N-7, N-10	2.1360	0.690	.0620
N-7-3B	N-7B	2.1360	0.690	.0620
N-7-3BX001	N-7BW	2.1360	0.690	.0625
N-7-4	N-7, N-7B, N-10	2.1260	0.690	.0620
N-7-4X001	N-7BW	2.1260	0.690	.0625
N-8-2	N-9	2.2160	0.625	.0620
N-8-3	N-9	2.1860	0.625	.0620
N-8-4	N-9	2.1560	0.625	.0620
N-8-5	N-9	2.1260	0.625	.0620
N-8-21	N-9R1	2.2260	0.625	.0670
N-8-31	N-9R1	2.1960	0.625	.0670
N-8-41	N-9R1	2.1660	0.625	.0670
N-8-51	N-9R1	2.1360	0.625	.0670
N-9-1	N-9	2.2460	0.920	.0620
N-9-11	N-9R1	2.2560	0.920	.0670
N-10-1	N-10	2.1560	0.690	.0620
NIA-1-1	NIA-1*, NIA-4*	1.7340	0.805	.0403
NIA-1-2	NIA-4*	1.7340	0.805	.0403

*Denotes (OHC) Repair Bearing, Check "Aluminum Overhead Cam Accessories" Section For Tool Information

**Denotes Auxiliary / Balance Shaft Bearing

"und" Denotes Undersized ID

BEARING COMPONENT LISTING

CONTENTS	IN SET(S)	HOUSING BORE	LENGTH	MAX WALL
NIA-1-3	NIA-4*	1.7340	1.120	.0403
NIA-2-1	NIA-2L*, NIA-2R*, NIA-3L*, NIA-3R*	1.9309	0.735	.0403
NIA-3-1	NIA-3R*	1.9702	1.235	.0403
NIA-3-2	NIA-3L*, NIA-3R*	1.7538	0.735	.0403
NIA-4-1	NIA-5*	1.8914	0.805	.0403
NIA-4-2	NIA-5*	1.8914	0.805	.0403
NIG-1-1	NIG-1**	2.1255	0.628	.0595
NIG-1-2	NIG-1**	2.1183	0.825	.0595
O-5-1	O-5	2.1288	0.688	.0641
O-6-1	O-6	2.1688	0.688	.0646
O-6-1B	O-6B	2.1688	0.688	.0646
O-6-2	O-6, O-7, O-8	2.1488	0.688	.0646
O-6-2B	O-6B	2.1488	0.688	.0646
O-6-3	O-6, O-7, O-8	2.1288	0.688	.0646
O-6-3B	O-6B	2.1288	0.688	.0646
O-6-4	O-6, O-7, O-8	2.1088	0.688	.0646
O-6-4B	O-6B	2.1088	0.688	.0646
O-6-5	O-6, O-7	2.0888	0.688	.0646
O-6-5B	O-6B	2.0888	0.688	.0646
O-7-1	O-7, O-8	2.1688	0.688	.0646
OG-1-1	OG-1**	2.1408	0.740	.0695
ON-1-1	ON-1	1.5000	0.697	.0619
OP-3-1	OP-3, OP-5	2.1069	0.950	.0889
OP-3-2	OP-3, OP-5	2.0970	0.723	.0889
OP-3-3	OP-3, OP-5	2.0773	0.723	.0840
OP-5-3	OP-5	2.0872	0.723	.0865
P-3-1	P-3	2.0307	1.060	.0644
P-3-2	P-3, P-4	2.0307	0.680	.0644
P-3-21	P-4R1	2.0407	0.680	.0694
PD-1-1	PD-1, PD-3	2.1295	1.093	.0645
PD-1-2	PD-1	2.0990	0.875	.0649
PD-1-3	PD-1	2.0675	0.875	.0650
PD-3-2	PD-3	2.0990	1.062	.0650
PD-3-3	PD-3	2.0675	1.062	.0650
PD-8-1	PD-8	2.1300	0.938	.0647
PD-8-2	PD-8	2.1300	0.813	.0647
PD-8-3	PD-8	1.5675	0.875	.0647
PD-9-2	PD-16	2.1140	0.760	.0645
PD-9-3	PD-16	2.0990	0.760	.0645
PD-9-4	PD-16	2.0830	0.760	.0645
PD-9-5	PD-16, PD-25, PD-27	1.6925	0.940	.0645
PD-12-2	PD-17, PD-18	2.1140	0.750	.0645
PD-12-3	PD-17	2.0990	0.669	.0645
PD-12-4	PD-17	2.0830	0.750	.0645
PD-12-5	PD-17	1.8800	0.750	.0645
PD-13-3	PD-18	2.0990	0.750	.0645
PD-13-4	PD-18, PD-21	2.0830	0.750	.0645
PD-16-1	PD-16, PD-25, PD-27	2.1300	0.875	.0645
PD-17-1	PD-17	2.1300	0.750	.0645
PD-18-1	PD-18	2.1300	0.920	.0645
PD-21-1	PD-21	2.1300	0.780	.0640
PD-21-2	PD-21	2.1140	0.625	.0640
PD-21-3	PD-21	2.0990	0.625	.0640
PD-25-2	PD-25, PD-27	2.1140	0.625	.0645
PD-25-3	PD-25	2.0990	0.615	.0645

*Denotes (OHC) Repair Bearing, Check "Aluminum Overhead Cam Accessories" Section For Tool Information

**Denotes Auxiliary / Balance Shaft Bearing

"und" Denotes Undersized ID

BEARING COMPONENT LISTING

CONTENTS	IN SET(S)	HOUSING BORE	LENGTH	MAX WALL
PD-25-4	PD-25, PD-27	2.0830	0.615	.0645
PD-28-1	PD-28, PD-28B	2.1300	0.930	.0647
PD-28-2	PD-28	2.1140	0.610	.0653
PD-28-2B	PD-28B	2.1140	0.610	.0653
PD-28-3	PD-28	2.0990	0.610	.0653
PD-28-3B	PD-28B	2.0990	0.610	.0653
PD-28-4	PD-28, PD-28B	2.0830	0.610	.0647
PD-30-1	PD-30	2.2235	0.885	.0650
PD-30-2	PD-30	2.2075	0.625	.0652
PD-30-3	PD-30	2.1915	0.625	.0650
PD-30-4	PD-30	2.1755	0.625	.0650
PD-30-5	PD-30	2.1595	0.625	.0650
PD-30-6	PD-30	2.0495	0.885	.0650
PD-31-1B	PD-31B	2.4231	0.665	.0650
PD-31-2B	PD-31B	2.4073	0.587	.0650
PD-31-3B	PD-31B	2.3916	0.587	.0650
PD-31-4B	PD-31B	2.3758	0.587	.0650
PD-31-5B	PD-31B	1.8499	0.587	.0650
PD-31-1W	PD-31BW	2.4231	0.665	.0655
PD-31-2W	PD-31BW	2.4073	0.587	.0655
PD-31-3W	PD-31BW	2.3916	0.587	.0655
PD-31-4W	PD-31BW	2.3758	0.587	.0655
PD-31-5W	PD-31BW	1.8499	0.587	.0655
PDA-1-1(L)	PDA-1*	1.4819	0.625	.0522
PDA-1-2(U)	PDA-1*	1.4819	0.625	.0522
PDA-2-1(L)	PDA-2*	1.4819	0.625	.0422
PDA-2-2(U)	PDA-2*	1.4819	0.625	.0422
PDA-3-1	PDA-3*	1.7035	0.815	.0404
PDA-3-2	PDA-3*	1.7195	0.775	.0406
PDA-3-3	PDA-3*	1.7345	0.775	.0402
PDA-3-4	PDA-3*	1.7505	0.775	.0404
PDA-3-5	PDA-3*	1.7665	0.745	.0404
PDA-4-1 (L)	PDA-4*	1.1085	0.585	.0418
PDA-4-2 (U)	PDA-4*	1.1085	0.585	.0418
PDG-1-1	PDG-1**	1.3390	0.785	.0789
PDG-26-1	PDG-26**	1.8110	0.745	.0640
PDG-26-2	PDG-26**	0.9055	0.825	.0640
PDG-29-1	PDG-29S**	1.7866	0.865	.08 Semi
PDG-30-1	PDG-30**	2.3533	0.710	.0728
PDG-30-2	PDG-30**	1.2903	0.710	.0728
PDP-9-2	PDP-16	2.1140	0.760	.0645
PDP-9-2T	PDP-16T	2.1140	0.760	.0645
PDP-9-3	PDP-16	2.0990	0.760	.0645
PDP-9-3T	PDP-16T	2.0990	0.760	.0645
PDP-9-4	PDP-16	2.0830	0.760	.0645
PDP-9-4T	PDP-16T	2.0830	0.760	.0645
PDP-9-5	PDP-16, PDP-25	1.6925	0.940	.0645
PDP-9-5T	PDP-16T, PDP-25T	1.6925	0.940	.0645
PDP-12-2	PDP-17	2.1140	0.750	.0645
PDP-12-2R1	PDP-17R1	2.1240	0.750	.0695
PDP-12-2T	PDP-17T	2.1140	0.750	.0645
PDP-12-3	PDP-17	2.0990	0.669	.0645
PDP-12-3R1	PDP-17R1	2.1090	0.669	.0695
PDP-12-3T	PDP-17T	2.0990	0.669	.0645
PDP-12-4	PDP-17	2.0830	0.750	.0645

*Denotes (OHC) Repair Bearing, Check "Aluminum Overhead Cam Accessories" Section For Tool Information

**Denotes Auxiliary / Balance Shaft Bearing

"und" Denotes Undersized ID

BEARING COMPONENT LISTING

CONTENTS	IN SET(S)	HOUSING BORE	LENGTH	MAX WALL
PDP-12-4R1	PDP-17R1	2.0930	0.750	.0695
PDP-12-4T	PDP-17T	2.0830	0.750	.0645
PDP-12-5	PDP-17	1.8800	0.750	.0645
PDP-12-5R1	PDP-17R1	1.8900	0.750	.0695
PDP-12-5T	PDP-17T	1.8800	0.750	.0645
PDP-16-1	PDP-16, PDP-25	2.1300	0.875	.0645
PDP-16-1T	PDP-16T, PDP-25T	2.1300	0.875	.0645
PDP-17-1	PDP-17	2.1300	0.750	.0645
PDP-17-1R1	PDP-17R1	2.1400	0.750	.0695
PDP-17-1T	PDP-17T	2.1300	0.750	.0645
PDP-25-2	PDP-25	2.1140	0.625	.0645
PDP-25-2T	PDP-25T	2.1140	0.625	.0645
PDP-25-3	PDP-25	2.0990	0.615	.0645
PDP-25-3T	PDP-25T	2.0990	0.615	.0645
PDP-25-4	PDP-25	2.0830	0.615	.0645
PDP-25-4T	PDP-25T	2.0830	0.615	.0645
PP-3-1	PP-3	2.0307	1.060	.0644
PP-3-1T	PP-3T	2.0307	1.060	.0644
PP-3-2	PP-3, PP-4	2.0307	0.680	.0644
PP-3-2T	PP-3T, PP-4T	2.0307	0.680	.0644
R-1-1	R-1	2.5620	1.625	.0610
R-1-2	R-1	2.4370	1.250	.0610
R-1-3	R-1	2.3120	1.250	.0610
R-1-4	R-1	1.7500	1.187	.0613
SA-1-1	SA-1*	1.8215	0.940	.0407
SA-1-2	SA-1*	1.8295	0.485	.0407
SA-1-3	SA-1*	1.8375	0.485	.0407
SA-1-4	SA-1*	1.8455	0.485	.0407
SA-1-5	SA-1*	1.8535	0.485	.0407
SH-1798T	CH-17G, CH-21G, CHG-15A**	NA	NA	NA
TO-1-1	TO-10	2.0475	1.143	.0785
TO-1-2	TO-10	1.9885	0.943	.0785
TO-1-4	TO-10	1.8705	0.984	.0785
TO-2-1	TO-2	1.9685	1.095	.0685
TO-2-2	TO-2	1.9685	1.654	.0735
TO-2-3	TO-2	1.9685	0.985	.0785
TO-3-1	TO-3	1.8895	0.715	.0929
TO-3-2	TO-3	1.8705	0.715	.0885
TO-3-3	TO-3	1.8510	0.715	.0835
TO-3-4	TO-3	1.8311	0.715	.0786
TO-5-1	TO-11	1.9688	1.142	.0686
TO-5-2	TO-11	1.9688	0.790	.0735
TO-5-4	TO-11	1.9688	0.750	.0835
TO-5-5	TO-11	1.9688	1.105	.0884
TO-7-1	TO-7	1.9691	0.705	.0687
TO-7-2	TO-7	1.9593	0.625	.0687
TO-7-3	TO-7	1.9297	0.705	.0588
TO-7-4	TO-7	1.9400	0.625	.0687
TO-7-5	TO-7	1.9494	0.705	.0785
TO-8-1	TO-8	1.4971	1.103	.0591
TO-8-2	TO-8	1.4971	0.793	.0591
TO-10-3	TO-10	1.9295	0.943	.0785
TO-11-3	TO-11	1.9688	1.810	.0785
TO-12-1	TO-12	1.9697	0.709	.0689
TO-12-2	TO-12	1.9598	0.630	.0689

*Denotes (OHC) Repair Bearing, Check "Aluminum Overhead Cam Accessories" Section For Tool Information

**Denotes Auxiliary / Balance Shaft Bearing

"und" Denotes Undersized ID

BEARING COMPONENT LISTING

CONTENTS	IN SET(S)	HOUSING BORE	LENGTH	MAX WALL
TO-12-3	TO-12	1.9303	0.709	.0591
TO-12-4	TO-12	1.9402	0.630	.0689
TO-12-5	TO-12	1.9500	0.709	.0788
TO-15-1	TO-15	2.2638	0.787	.0791
TO-15-2	TO-15	2.2539	0.787	.0791
TO-15-3	TO-15	2.2047	0.787	.0594
TO-15-4	TO-15	2.2047	0.787	.0644
TO-15-5	TO-15	2.2146	0.787	.0742
TOA-1-1(U)	NIA-6*	1.3841	0.800	.0422
TOA-1-2(L)	NIA-6*	1.3841	0.800	.0422
TOA-2-1(L)	TOA-1*	1.3841	0.800	.0418
TOA-2-2(U)	TOA-1*	1.3841	0.800	.0418
TOG-8-1	TOG-8**	1.9682	0.975	.0784
TOG-8-2	TOG-8**	1.7714	0.785	.0784
TOG-9-1	TOG-9**	1.7719	0.640	.0788
TOG-9-2	TOG-9**	1.4569	0.640	.0788
TOG-10-1	TOG-10**	1.6541	0.800	.0783
TOG-10-2	TOG-10**	1.6350	0.895	.0790
TOG-11-1	TOG-11**, TOG-11A**, TOG-11C**	1.2615	0.765	.0597
TOG-11-2	TOG-11**, TOG-11C**	1.2615	0.765	.0597
TOG-11-3	TOG-11**, TOG-11A**, TOG-11C**	1.2615	0.765	.0597
VHA-1-2(L)	MZA-4*	1.2655	0.700	.0422
VHA-1-2(U)	VOA-1*	1.2655	0.700	.0422
VO-2-1	VO-2**, VO-3	1.9655	1.060	.0570
VO-2-2	VO-2**	1.8081	1.025	.0570
VO-2-3	VO-2**	1.5724	1.100	.0573
VOA-1-1(L)	VOA-1*	1.2655	0.700	.0422
VW-1-1	VW-1	1.0831	0.787	.0490
VW-1-2	VW-1	1.0831	0.906	.0490
VW-1-3(L)	VW-1	1.0831	1.102	.0490
VW-1-3(U)	VW-1	1.0831	1.102	.0490
VWA-1-1(U)	VWA-1*	1.3439	0.830	.0422
VWA-1-2(U)	VWA-1*	1.2655	0.830	.0422
VWA-1-3(L)	VWA-1*	1.2655	0.630	.0422
VWA-1-4(U)	VWA-1*	1.2655	0.630	.0422
VWA-1-5(L)	VWA-1*	1.2655	0.700	.0422
VWA-2-1(L)	VWA-2*	1.1085	0.680	.0422
VWA-2-2(U)	VWA-2*	1.1085	0.680	.0422
VWG-1-1	VWG-1**	1.8115	0.585	.0590
VWG-1-2	VWG-1**	1.7721	0.585	.0590
WA-1-1	WA-4, WA-7	1.8750	1.000	.0617
WA-2-1	WA-10	2.2500	1.250	.0614
WA-3-1	WA-3	2.2540	1.125	.0643
WA-3-2	WA-3	2.0040	1.312	.0645
WA-3-3	WA-3	1.6290	1.500	.0645
WA-8-1	WA-8, WA-12	2.1250	1.067	.0605
WA-8-2	WA-8, WA-12	2.1250	0.880	.0605
WA-9-1	WA-9	2.8750	1.880	.0645
WA-9-2	WA-9	2.8750	1.505	.0645
WA-9-3	WA-9	2.1870	2.255	.0643
WA-11-1	WA-11	2.6250	1.500	.0618

*Denotes (OHC) Repair Bearing, Check "Aluminum Overhead Cam Accessories" Section For Tool Information

**Denotes Auxiliary / Balance Shaft Bearing

"und" Denotes Undersized ID

BEARING COMPONENT PROGRESSIVE LISTING BY HOUSING BORE

HOUSING BORE	LENGTH	MAX WALL	CONTENTS	IN SET(S)
0.6330	0.875	NA	MIG-2-EL	MIG-2E**
0.9055	0.825	.0640	PDG-26-2	PDG-26**
0.9453	0.635	.0585	MZG-3-3	MZG-3**
1.0240	0.703	.0589	MIG-2-2	MIG-2**
1.0831	0.787	.0490	VW-1-1	VW-1
1.0831	0.906	.0490	VW-1-2	VW-1
1.0831	1.102	.0490	VW-1-3(L)	VW-1
1.0831	1.102	.0490	VW-1-3(U)	VW-1
1.1085	0.585	.0418	PDA-4-1 (L)	PDA-4*
1.1085	0.585	.0418	PDA-4-2 (U)	PDA-4*
1.1085	0.680	.0422	VWA-2-1(L)	VWA-2*
1.1085	0.680	.0422	VWA-2-2(U)	VWA-2*
1.1469	0.455	.0420	FA-4-1(L)	FA-4*, FA-5*
1.1469	0.455	.0420	FA-4-2(L)	FA-4*, FA-5*
1.1469	0.455	.0420	FA-4-4(U)	FA-4*, FA-5*
1.1469	0.570	.0420	FA-4-3(U)	FA-4*, FA-5*
1.1469	0.570	.0422	FA-3-1(L)	FA-3*, FA-14L*, FA-14R*
1.1469	0.570	.0422	FA-3-1S(U)	FA-14L*
1.1469	0.570	.0422	FA-3-2(L)	FA-4*
1.1469	0.570	.0422	FA-3-2(U)	FA-3*, FA-14L*, FA-14R*
1.1469	0.570	.0422	FA-5-1(L)	FA-5*
1.1875	0.535	.0422	HA-3-3(L)	HA-3*, HA-5*
1.1875	0.535	.0422	HA-3-4(U)	HA-3*, HA-5*
1.1875	0.680	.0422	FA-6-3(L)	FA-6*
1.1875	0.680	.0422	FA-6-4(U)	FA-6*
1.1875	0.735	.0422	HA-3-1(L)	HA-3*
1.1875	0.735	.0422	HA-3-2(U)	HA-3*
1.1875	0.960	.0422	FA-6-1(L)	FA-6*
1.1875	0.960	.0422	FA-6-2(U)	FA-6*
1.2132	0.700	.0422	FA-13-3(L)	FA-13L*, FA-13R*
1.2132	0.700	.0422	FA-13-4(U)	FA-13L*, FA-13R*
1.2132	1.215	.0422	FA-13-1(L)	FA-13L*
1.2132	1.215	.0422	FA-13-2(U)	FA-13L*, FA-13R*
1.2132	1.215	.0422	FA-13-5(L)	FA-13R*
1.2615	0.765	.0597	TOG-11-1	TOG-11**, TOG-11A**, TOG-11C**
1.2615	0.765	.0597	TOG-11-2	TOG-11**, TOG-11C**
1.2615	0.765	.0597	TOG-11-3	TOG-11**, TOG-11A**, TOG-11C**
1.2655	0.530	.0618	HA-4-3(U)	HA-4*
1.2655	0.530	.0618	HA-4-4(L)	HA-4*
1.2655	0.630	.0422	VWA-1-3(L)	VWA-1*
1.2655	0.630	.0422	VWA-1-4(U)	VWA-1*
1.2655	0.665	.0617	GMA-2-1(L)	GMA-2*
1.2655	0.665	.0617	GMA-2-1(U)	GMA-2*
1.2655	0.665	.0617	GMA-2-2(L)	GMA-2*
1.2655	0.665	.0617	GMA-2-3(U)	GMA-2*
1.2655	0.700	.0422	MZA-4-1(U)	MZA-4*
1.2655	0.700	.0422	VHA-1-2(L)	MZA-4*
1.2655	0.700	.0422	VHA-1-2(U)	VOA-1*
1.2655	0.700	.0422	VOA-1-1(L)	VOA-1*
1.2655	0.700	.0422	VWA-1-5(L)	VWA-1*
1.2655	0.700	.0622	HA-1-1(U)	HA-1*
1.2655	0.700	.0622	HA-1-4(U)	HA-2*
1.2655	0.700	.0622	HA-1-4A(U)	HA-2*
1.2655	0.700	.0622	HA-1-5(L)	HA-1*, HA-2*
1.2655	0.700	.0622	HA-1-5(U)	HA-2*

*Denotes (OHC) Repair Bearing, Check "Aluminum Overhead Cam Accessories" Section For Tool Information

**Denotes Auxiliary / Balance Shaft Bearing

"und" Denotes Undersized ID

BEARING COMPONENT PROGRESSIVE LISTING BY HOUSING BORE

HOUSING BORE	LENGTH	MAX WALL	CONTENTS	IN SET(S)
1.2655	0.788	.0618	HA-5-1(L)	HA-5*
1.2655	0.788	.0618	HA-5-2(U)	HA-5*
1.2655	0.830	.0422	VWA-1-2(U)	VWA-1*
1.2655	0.830	.0618	HA-1-2(U)	HA-2*
1.2655	0.830	.0618	HA-1-3(L)	HA-2*
1.2655	1.242	.0618	HA-4-1(U)	HA-4*
1.2655	1.242	.0618	HA-4-2(L)	HA-4*
1.2903	0.710	.0728	PDG-30-2	PDG-30**
1.3390	0.785	.0789	PDG-1-1	PDG-1**
1.3439	0.700	.0422	MZA-2-1(U)	MZA-2*
1.3439	0.830	.0422	MZA-2-2(L)	MZA-2*
1.3439	0.830	.0422	MZA-2-3(L)	VWA-1*
1.3439	0.830	.0422	MZA-2-3(U)	MZA-2*
1.3439	0.830	.0422	VWA-1-1(U)	VWA-1*
1.3745	1.000	.0615	BU-1-3	BU-2
1.3748	1.156	.0628	K-1-4	CO-3, CO-8, K-1
1.3790	0.875	.0637	HO-3-4	HO-3
1.3841	0.800	.0418	TOA-2-1(L)	TOA-1*
1.3841	0.800	.0418	TOA-2-2(U)	TOA-1*
1.3841	0.800	.0422	TOA-1-1(U)	NIA-6*
1.3841	0.800	.0422	TOA-1-2(L)	NIA-6*
1.4225	0.710	.0422	MIA-5-2(U)	MIA-5*
1.4225	0.710	.0422	MIA-5-6(L)	MIA-5*
1.4225	0.760	.0422	MIA-5-3(U)	MIA-5*
1.4225	0.760	.0422	MIA-5-7(L)	MIA-5*
1.4225	0.793	.0422	MIA-5-1(U)	MIA-5*
1.4225	0.793	.0422	MIA-5-5(L)	MIA-5*
1.4225	0.795	.0422	MIA-1-1(U)	MIA-1*, MIA-4*
1.4225	0.795	.0422	MIA-1-3(U)	MIA-1*
1.4225	0.795	.0422	MIA-1-4(L)	MIA-1*, MIA-4*
1.4225	0.795	.0422	MIA-1-8(U)	MIA-4*
1.4225	0.980	.0422	MIA-5-8(U)	MIA-5*
1.4225	0.980	.0422	MIA-5-9(L)	MIA-5*
1.4569	0.640	.0788	TOG-9-2	TOG-9**
1.4587	1.000	.0398	BMA-4-3	BMA-4*
1.4587	1.390	.0403	BMA-1-4	BMA-1*
1.4819	0.625	.0422	PDA-2-1(L)	PDA-2*
1.4819	0.625	.0422	PDA-2-2(U)	PDA-2*
1.4819	0.625	.0522	PDA-1-1(L)	PDA-1*
1.4819	0.625	.0522	PDA-1-2(U)	PDA-1*
1.4971	0.793	.0591	TO-8-2	TO-8
1.4971	0.793	.0792	MIA-1-5(U)	MIA-2*
1.4971	0.793	.0792	MIA-1-6(L)	MIA-2*
1.4971	0.793	.0792	MIA-1-7(U)	MIA-2*
1.4971	1.103	.0591	TO-8-1	TO-8
1.4993	1.000	.0643	IN-15-3	IN-15
1.5000	0.697	.0619	ON-1-1	ON-1
1.5039	0.533	.0644	BL-1-3	BL-1
1.5675	0.875	.0647	PD-8-3	PD-8
1.5682	0.875	.0642	C-2-2	C-2
1.5724	1.100	.0573	VO-2-3	VO-2**
1.5772	0.800	.0403	BMA-1-10	BMA-2*, BMA-3*
1.5969	0.865	.0808	CHG-23-2	CHG-23**
1.6050	1.020	.0786	CHG-24-1	CHG-24**
1.6250	1.090	.0608	JDG-7-1	JDG-7**

*Denotes (OHC) Repair Bearing, Check "Aluminum Overhead Cam Accessories" Section For Tool Information

**Denotes Auxiliary / Balance Shaft Bearing

"und" Denotes Undersized ID

BEARING COMPONENT PROGRESSIVE LISTING BY HOUSING BORE

HOUSING BORE	LENGTH	MAX WALL	CONTENTS	IN SET(S)
1.6253	0.865	.0808	CHG-23-1	CHG-23**
1.6260	1.060	.0620	H-5-5	H-5
1.6290	1.500	.0645	WA-3-3	WA-3
1.6303	0.790	.0641	IN-18-3	IN-18
1.6313	1.312	.0645	IN-8-4	IN-14
1.6313	1.530	.0645	IN-2-4	IN-3, IN-16
1.6350	0.895	.0790	TOG-10-2	TOG-10**
1.6541	0.800	.0783	TOG-10-1	TOG-10**
1.6890	0.685	.0633	F-28-2	F-28
1.6890	0.790	.0633	F-28-1	F-28
1.6890	0.790	.0633	F-28-3	F-28
1.6925	0.940	.0645	PD-9-5	PD-16, PD-25, PD-27
1.6925	0.940	.0645	PDP-9-5	PDP-16, PDP-25
1.6925	0.940	.0645	PDP-9-5T	PDP-16T, PDP-25T
1.7035	0.815	.0404	PDA-3-1	PDA-3*
1.7083	1.005	.0641	IN-18-2	IN-18
1.7108	0.785	.0644	HO-2-5	HO-2
1.7128	0.785	.0644	HO-2-5S	HO-2S
1.7128	0.785	.0644	HOP-2-5S	HOP-2S
1.7128	0.785	.0644	HOP-2-5ST	HOP-2ST
1.7195	0.775	.0406	PDA-3-2	PDA-3*
1.7285	0.595	.0604	F-31-4	F-31, F-42
1.7326	1.030	.0780	MZG-3-2	MZG-3**
1.7328	0.825	.0592	MIG-3-2	MIG-3**
1.7340	0.805	.0403	NIA-1-1	NIA-1*, NIA-4*
1.7340	0.805	.0403	NIA-1-2	NIA-4*
1.7340	1.085	.0400	BMA-1-9	BMA-4*
1.7340	1.120	.0403	NIA-1-3	NIA-4*
1.7345	0.775	.0402	PDA-3-3	PDA-3*
1.7435	0.700	.0604	F-31-3	F-31
1.7435	0.700	.0604	F-42-2	F-42
1.7495	0.555	.0625	DA-1-5	DA-1
1.7495	0.812	.0624	DA-2-3	DA-2
1.7495	0.947	.0625	DA-3-3A	DA-3A, DA-5
1.7500	1.187	.0613	R-1-4	R-1
1.7505	0.775	.0404	PDA-3-4	PDA-3*
1.7538	0.735	.0403	NIA-3-2	NIA-3L*, NIA-3R*
1.7539	0.755	.0644	BL-1-2	BL-1
1.7585	0.700	.0604	F-31-2	F-31
1.7585	0.775	.0604	F-42-1	F-42
1.7665	0.745	.0404	PDA-3-5	PDA-3*
1.7714	0.785	.0784	TOG-8-2	TOG-8**
1.7719	0.640	.0788	TOG-9-1	TOG-9**
1.7721	0.585	.0590	VWG-1-2	VWG-1**
1.7721	0.745	.0590	MIG-3-1	MIG-3**
1.7734	0.775	.0604	F-31-1	F-31
1.7734	0.775	.0604	FP-33-1	FP-33
1.7734	0.775	.0604	FP-33-1T	FP-33T
1.7741	1.115	.0403	BMA-1-8	BMA-4*
1.7750	0.500	.0606	AGB-29-1	FG-29**
1.7755	0.785	.0600	F-29-1	F-29
1.7775	0.500	.0614	AGB-34-2	FG-34**
1.7866	0.865	.08 Semi	PDG-29-1	PDG-29S**
1.7918	0.555	.0625	DA-1-4	DA-1
1.7931	0.730	.0403	MZA-1-1	MZA-1*

*Denotes (OHC) Repair Bearing, Check "Aluminum Overhead Cam Accessories" Section For Tool Information

**Denotes Auxiliary / Balance Shaft Bearing

"und" Denotes Undersized ID

BEARING COMPONENT PROGRESSIVE LISTING BY HOUSING BORE

HOUSING BORE	LENGTH	MAX WALL	CONTENTS	IN SET(S)
1.7931	0.730	.0403	MZA-1-2	MZA-1*
1.7931	0.730	.0403	MZA-1-3	MZA-1*
1.7960	1.125	.0644	BL-1-1	BL-1
1.7965	0.750	.0643	B-4-5	B-6, B-8, B-11
1.7975	0.500	.0714	AGB-34-1	FG-34**
1.8072	0.595	.0605	F-47-4	F-47, F-47B
1.8072	0.905	.0610	FG-53-2	FG-53**
1.8081	1.025	.0570	VO-2-2	VO-2**
1.8110	0.745	.0640	PDG-26-1	PDG-26**
1.8114	0.910	.0781	MZG-3-1	MZG-3**
1.8115	0.555	.0625	DA-1-3	DA-1
1.8115	0.585	.0590	VWG-1-1	VWG-1**
1.8125	1.135	.0626	CO-9-3	CO-9
1.8126	0.785	.0587	MIG-2-1	MIG-2**
1.8126	0.930	NA	MIG-1-EL	MIG-2E**
1.8131	0.800	.0403	BMA-1-3	BMA-1*, BMA-2*, BMA-3*
1.8131	0.800	.0500	BMA-1-7	BMA-3*
1.8215	0.940	.0407	SA-1-1	SA-1*
1.8222	0.700	.0605	F-47-3	F-47
1.8222	0.700	.0605	F-47-3B	F-47B
1.8265	0.750	.0643	B-4-4	B-6, B-8, B-11
1.8295	0.485	.0407	SA-1-2	SA-1*
1.8311	0.715	.0786	TO-3-4	TO-3
1.8312	0.555	.0625	DA-1-2	DA-1
1.8371	0.700	.0605	F-47-2	F-47
1.8371	0.700	.0605	F-47-2B	F-47B
1.8375	0.485	.0407	SA-1-3	SA-1*
1.8435	0.845	.0403	FA-2-1	FA-2*
1.8455	0.485	.0407	SA-1-4	SA-1*
1.8499	0.587	.0650	PD-31-5B	PD-31B
1.8499	0.587	.0655	PD-31-5W	PD-31BW
1.8509	0.930	.0625	DA-1-1	DA-1
1.8510	0.715	.0835	TO-3-3	TO-3
1.8521	0.780	.0605	F-47-1	F-47, F-47B
1.8522	1.142	.0610	FG-53-1	FG-53**
1.8524	0.800	.0403	BMA-1-2	BMA-1*, BMA-2*, BMA-3*
1.8524	0.995	.0500	BMA-1-6	BMA-3*
1.8535	0.485	.0407	SA-1-5	SA-1*
1.8535	0.845	.0403	FA-2-2	FA-2*
1.8555	0.865	.0625	DA-3-2	DA-3A, DA-5
1.8555	1.070	.0624	DA-2-2	DA-2
1.8565	0.750	.0643	B-4-3	B-6, B-8, B-11
1.8607	0.661	.0550	GMA-1-2	GMA-1*
1.8607	0.817	.0550	GMA-1-1	GMA-1*
1.8635	0.845	.0403	FA-2-3	FA-2*
1.8672	0.862	.0808	CHG-23-3	CHG-23**
1.8705	0.715	.0885	TO-3-2	TO-3
1.8705	0.984	.0785	TO-1-4	TO-10
1.8735	0.845	.0403	FA-2-4	FA-2*
1.8740	0.835	.1860	CHG-15-1	CH-17G, CH-21G, CHG-15A**
1.8750	0.573	.0626	CO-9-2	CO-9
1.8750	1.000	.0617	WA-1-1	WA-4, WA-7
1.8750	1.620	.0628	K-1-3	CO-3, CO-8, K-1
1.8753	0.550	.0617	HE-5-2	HE-5
1.8753	1.020	.0617	HE-5-1	HE-5

*Denotes (OHC) Repair Bearing, Check "Aluminum Overhead Cam Accessories" Section For Tool Information

**Denotes Auxiliary / Balance Shaft Bearing

"und" Denotes Undersized ID

BEARING COMPONENT PROGRESSIVE LISTING BY HOUSING BORE

HOUSING BORE	LENGTH	MAX WALL	CONTENTS	IN SET(S)
1.8785	0.665	.0600	F-29-2	F-29
1.8797	0.620	.0637	C-3-1	C-3
1.8797	0.750	.0641	C-2-1	C-2
1.8800	0.750	.0645	PD-12-5	PD-17
1.8800	0.750	.0645	PDP-12-5	PDP-17
1.8800	0.750	.0645	PDP-12-5T	PDP-17T
1.8805	0.495	.0642	CA-4-2	CA-4, CA-5, CA-8, CA-9
1.8805	0.718	.0642	CA-3-2	CA-3
1.8805	0.718	.0642	CA-5-3	CA-5
1.8805	0.970	.0640	CA-9-1	CA-9
1.8805	1.125	.0642	A-1-1	A-1, A-6
1.8805	1.125	.0642	A-6-1	A-6
1.8805	1.187	.0642	CA-3-3	CA-3
1.8805	1.218	.0643	CA-4-1	CA-4, CA-5, CA-8, CA-9
1.8805	1.312	.0642	CA-3-1	CA-3
1.8835	0.845	.0403	FA-2-5	FA-2*
1.8835	0.925	.0403	FA-1-5	FA-1*
1.8865	0.750	.0642	B-6-1	B-6, B-8, B-11
1.8885	0.925	.0428	FA-1-4	FA-1*
1.8895	0.715	.0929	TO-3-1	TO-3
1.8895	0.984	.0586	AGB-14-1	CHG-14**
1.8900	0.750	.0695	PDP-12-5R1	PDP-17R1
1.8914	0.805	.0403	NIA-4-1	NIA-5*
1.8914	0.805	.0403	NIA-4-2	NIA-5*
1.8918	0.685	.0403	MIA-3-1	MIA-3*
1.8918	0.800	.0403	BMA-1-1	BMA-1*, BMA-2*, BMA-3*
1.8918	0.800	.0500	BMA-1-5	BMA-3*
1.8935	0.625	.0600	F-29-3A	F-29
1.8935	0.925	.0453	FA-1-3	FA-1*
1.8955	0.862	.0808	CHG-23-4	CHG-23**
1.8968	0.815	.0643	HO-1-1	HO-1
1.8985	0.925	.0478	FA-1-2	FA-1*
1.9011	0.693	.0638	F-34-1	F-34
1.9011	0.693	.0638	F-34-1B	F-34B
1.9035	0.925	.0503	FA-1-1	FA-1*
1.9100	0.875	.0637	HO-3-3	HO-3
1.9155	0.945	.0625	DA-3-1	DA-3A, DA-5
1.9155	1.455	.0624	DA-2-1	DA-2
1.9165	0.620	.0642	B-9-2	B-9, B-12, B-12B, B-13
1.9165	0.620	.0642	BP-9-2	BP-9, BP-13
1.9165	0.620	.0642	BP-9-2T	BP-9T, BP-13T
1.9165	0.750	.0642	B-11-1	B-9, B-11, B-12
1.9165	0.750	.0642	B-11-1B	B-12B
1.9165	0.750	.0642	BP-11-1	BP-9
1.9165	0.750	.0642	BP-11-1T	BP-9T
1.9165	0.750	.0642	LR-1-1	LR-1
1.9165	0.750	.0643	B-4-1	B-8
1.9170	0.810	.0647	N-5-4	N-6
1.9203	0.693	.0738	F-34-1S	F-34S
1.9270	0.780	.0647	N-5-3	N-6
1.9280	0.938	.0579	JD-1-2	JD-1, JD-2
1.9280	1.181	.0579	JD-1-1	JD-1, JD-2
1.9280	1.220	.0577	JD-5-2	JD-5
1.9280	1.312	.0648	F-1-2	F-1
1.9280	1.598	.0577	JD-5-1	JD-5

*Denotes (OHC) Repair Bearing, Check "Aluminum Overhead Cam Accessories" Section For Tool Information

**Denotes Auxiliary / Balance Shaft Bearing

"und" Denotes Undersized ID

BEARING COMPONENT PROGRESSIVE LISTING BY HOUSING BORE

HOUSING BORE	LENGTH	MAX WALL	CONTENTS	IN SET(S)
1.9280	1.600	.0648	F-1-1	F-1
1.9295	0.943	.0785	TO-10-3	TO-10
1.9297	0.705	.0588	TO-7-3	TO-7
1.9299	0.714	.0794	F-41-2	F-41*
1.9299	0.949	.0794	F-41-1	F-41*
1.9303	0.709	.0591	TO-12-3	TO-12
1.9309	0.735	.0403	NIA-2-1	NIA-2L*, NIA-2R*, NIA-3L*, NIA-3R*
1.9335	0.720	.0607	F-17-4	F-32
1.9365	0.750	.0743	B-13-1	B-13
1.9365	0.750	.0743	BP-13-1	BP-13
1.9365	0.750	.0743	BP-13-1T	BP-13T
1.9368	1.375	.0643	IN-15-2	IN-15
1.9370	0.780	.0647	N-5-2	N-6
1.9370	1.250	.0940	CO-7-4	CO-7
1.9375	0.937	.0630	K-1-2	CO-3, K-1
1.9375	1.323	.0626	CO-9-1	CO-9
1.9400	0.625	.0687	TO-7-4	TO-7
1.9402	0.630	.0689	TO-12-4	TO-12
1.9410	0.875	.0637	HO-3-2	HO-3
1.9430	1.095	.0645	IN-18-1	IN-18
1.9470	0.940	.0647	N-6-1	N-6
1.9485	0.720	.0682	F-17-3	F-32
1.9494	0.705	.0785	TO-7-5	TO-7
1.9500	0.709	.0788	TO-12-5	TO-12
1.9593	0.625	.0687	TO-7-2	TO-7
1.9598	0.630	.0689	TO-12-2	TO-12
1.9625	0.620	.0642	B-9-2R	B-13R
1.9625	0.750	.0743	B-13-1R	B-13R
1.9635	0.720	.0757	F-17-2	F-32
1.9655	1.060	.0570	VO-2-1	VO-2**, VO-3
1.9682	0.975	.0784	TOG-8-1	TOG-8**
1.9685	0.985	.0785	TO-2-3	TO-2
1.9685	1.095	.0685	TO-2-1	TO-2
1.9685	1.654	.0735	TO-2-2	TO-2
1.9688	0.750	.0835	TO-5-4	TO-11
1.9688	0.790	.0735	TO-5-2	TO-11
1.9688	1.105	.0884	TO-5-5	TO-11
1.9688	1.142	.0686	TO-5-1	TO-11
1.9688	1.810	.0785	TO-11-3	TO-11
1.9691	0.705	.0687	TO-7-1	TO-7
1.9697	0.709	.0689	TO-12-1	TO-12
1.9702	1.235	.0403	NIA-3-1	NIA-3R*
1.9725	0.937	.0644	CH-2-4	CH-2
1.9725	1.150	.0641	GM-5-4	GM-5
1.9730	1.000	.0637	HO-3-1	HO-3
1.9765	0.630	.0641	B-14-2	B-14
1.9785	0.720	.0832	F-32-1	F-32
1.9855	0.788	.1450	MIG-2-1R	MIG-2-1R**
1.9885	0.943	.0785	TO-1-2	TO-10
1.9965	0.745	.0741	B-14-1	B-14
1.9993	1.063	.0643	IN-5-3	IN-5
1.9995	0.630	.0640	CH-18-2	CH-18, CH-19, CHG-22**
1.9995	0.630	.0650	CH-18-2X2	CH-19X2
1.9995	0.720	.0640	CH-18-2A	CH-18A
2.0000	0.710	.0644	CH-20-1	CH-20

*Denotes (OHC) Repair Bearing, Check "Aluminum Overhead Cam Accessories" Section For Tool Information

**Denotes Auxiliary / Balance Shaft Bearing

"und" Denotes Undersized ID

BEARING COMPONENT PROGRESSIVE LISTING BY HOUSING BORE

HOUSING BORE	LENGTH	MAX WALL	CONTENTS	IN SET(S)
2.0000	0.740	.0644	CH-4-3	CH-4, CH-8, CH-17, CH-17G, CH-21, CH-21G, RDC-1
2.0000	0.740	.0644	CHP-4-3	CHP-4, CHP-8, CHP-17, CHP-21, GMP-8, RDCP-1
2.0000	0.740	.0644	CHP-4-3T	CHP-4T, CHP-8T, CHP-17T, CHP-21T, GMP-8T, RDCP-1T
2.0000	0.740	.0644	DT-1-1	DT-1
2.0000	0.740	.0644	DT-1-1T	DT-1T
2.0000	0.740	.0649	CH-4-3W	CH-8W, CH-17X, CH-21X
2.0000	0.785	.0644	HO-2-4	HO-2, HO-2S
2.0000	0.785	.0644	HOP-2-4	HOP-2S
2.0000	0.785	.0644	HOP-2-4T	HOP-2ST
2.0000	0.860	.0644	CH-5-3	CH-5, CH-6, CH-7, CH-11, CH-16, RDC-1
2.0000	0.860	.0644	CH-5-3B	CH-11B
2.0000	0.860	.0644	CHP-5-3	RDCP-1
2.0000	0.860	.0644	CHP-5-3T	RDCP-1T
2.0000	0.860	.0649	CH-5-3W	CH-16W
2.0000	0.875	.0628	K-1-1	CO-8, K-1
2.0040	1.312	.0645	WA-3-2	WA-3
2.0055	1.308	.0643	A-2-1	A-2
2.0095	0.625	.0691	CH-18-4	CH-18, CH-18A, CH-19, CHG-22**
2.0095	0.625	.0701	CH-18-4X2	CH-19X2
2.0100	0.625	.0691	CH-18-1A	CH-18, CH-18A
2.0100	0.740	.0694	CH-4-2	CH-4, CH-8, CH-17, CH-17G, CH-21, CH-21G
2.0100	0.740	.0694	CHP-4-2	CHP-4, CHP-8, CHP-17, CHP-21
2.0100	0.740	.0694	CHP-4-2T	CHP-4T, CHP-8T, CHP-17T, CHP-21T
2.0100	0.740	.0694	DT-1-11T	DT-1TR1
2.0100	0.740	.0699	CH-4-2W	CH-8W, CH-17X, CH-21X
2.0100	0.785	.0694	HO-2-3	HO-2, HO-2S
2.0100	0.785	.0694	HOP-2-3	HOP-2S
2.0100	0.785	.0694	HOP-2-3T	HOP-2ST
2.0100	0.860	.0694	CH-5-2	CH-5, CH-6, CH-7
2.0100	0.940	.0694	CH-4-4	CH-4
2.0100	0.940	.0694	CH-5-4	CH-5
2.0100	0.940	.0694	CHP-4-4	CHP-4
2.0100	0.940	.0694	CHP-4-4T	CHP-4T
2.0100	1.172	.0691	CHG-22-1	CHG-22**
2.0199	0.625	.0741	CH-19-1	CH-19
2.0199	0.625	.0751	CH-19-1X2	CH-19X2
2.0200	0.740	.0744	CH-4-1	CH-4, CH-8, CH-17, CH-17G, CH-21, CH-21G
2.0200	0.740	.0744	CHP-4-1	CHP-4, CHP-8, CHP-17, CHP-21
2.0200	0.740	.0744	CHP-4-1T	CHP-4T, CHP-8T, CHP-17T, CHP-21T
2.0200	0.740	.0749	CH-4-1W	CH-8W, CH-17X, CH-21X
2.0200	0.785	.0644	HO-2-2	HO-2, HO-2S
2.0200	0.785	.0644	HOP-2-2	HOP-2S
2.0200	0.785	.0644	HOP-2-2T	HOP-2ST
2.0200	0.860	.0744	CH-5-1	CH-5
2.0207	0.630	.0641	B-14-2R	B-14R
2.0207	0.745	.0741	B-14-1R	B-14R
2.0300	0.720	.0798	CH-18-2R2	CH-18RS
2.0300	0.740	.0794	CHP-4-11	CHP-8R1
2.0300	0.740	.0794	CHP-4-11T	CHP-8R1T
2.0300	0.740	.0795	CH-4-1S	CH-4A
2.0300	0.785	.0694	HO-2-1	HO-2, HO-2S
2.0300	0.785	.0694	HOP-2-1	HOP-2S
2.0300	0.785	.0694	HOP-2-1T	HOP-2ST
2.0307	0.680	.0644	P-3-2	P-3, P-4
2.0307	0.680	.0644	PP-3-2	PP-3, PP-4

*Denotes (OHC) Repair Bearing, Check "Aluminum Overhead Cam Accessories" Section For Tool Information

**Denotes Auxiliary / Balance Shaft Bearing

"und" Denotes Undersized ID

BEARING COMPONENT PROGRESSIVE LISTING BY HOUSING BORE

HOUSING BORE	LENGTH	MAX WALL	CONTENTS	IN SET(S)
2.0307	0.680	.0644	PP-3-2T	PP-3T, PP-4T
2.0307	1.060	.0644	P-3-1	P-3
2.0307	1.060	.0644	PP-3-1	PP-3
2.0307	1.060	.0644	PP-3-1T	PP-3T
2.0327	0.585	.0615	F-50-4	F-50
2.0327	0.825	.0615	F-50-4A	F-50A
2.0350	0.937	.0644	CH-2-3	CH-2
2.0400	0.625	.0847	CH-18-4R4	CH-18RS
2.0400	0.625	.0848	CH-18-1R3	CH-18RS
2.0400	0.740	.0844	CHP-4-12	CHP-8R2
2.0400	0.740	.0844	CHP-4-12T	CHP-8R2T
2.0407	0.680	.0694	P-3-21	P-4R1
2.0475	1.143	.0785	TO-1-1	TO-10
2.0476	0.700	.0614	F-50-3	F-50, F-50A
2.0479	0.984	.0790	IZ-2-1	IZ-2
2.0480	0.984	.0790	IZ-2-2	IZ-2
2.0480	0.984	.0790	IZ-2-3	IZ-2
2.0486	0.866	.0797	IZ-3-1	IZ-3
2.0486	0.866	.0797	IZ-3-2	IZ-3
2.0486	0.866	.0797	IZ-3-3	IZ-3
2.0495	0.885	.0650	PD-30-6	PD-30
2.0500	0.740	.0894	CHP-4-13	CHP-8R3
2.0500	0.740	.0894	CHP-4-13T	CHP-8R3T
2.0580	0.620	.0648	F-9-2B	F-9B
2.0580	0.620	.0648	F-9-3	F-9A
2.0580	0.875	.0648	F-9-1	F-9A, F-9B
2.0580	0.875	.0649	F-7-2	F-7
2.0580	0.875	.0649	F-22-1	F-7, F-22
2.0600	0.740	.0944	CHP-4-14	CHP-8R4
2.0600	0.740	.0944	CHP-4-14T	CHP-8R4T
2.0618	1.000	.0643	IN-15-1	IN-15
2.0626	0.700	.0614	F-50-2	F-50, F-50A
2.0675	0.875	.0650	PD-1-3	PD-1
2.0675	1.062	.0650	PD-3-3	PD-3
2.0773	0.723	.0840	OP-3-3	OP-3, OP-5
2.0776	0.775	.0617	F-50-1	F-50, F-50A
2.0800	0.720	.1040	CH-18-2R8	CH-18R8
2.0830	0.610	.0647	PD-28-4	PD-28, PD-28B
2.0830	0.615	.0645	PD-25-4	PD-25, PD-27
2.0830	0.615	.0645	PDP-25-4	PDP-25
2.0830	0.615	.0645	PDP-25-4T	PDP-25T
2.0830	0.750	.0645	PD-12-4	PD-17
2.0830	0.750	.0645	PD-13-4	PD-18, PD-21
2.0830	0.750	.0645	PDP-12-4	PDP-17
2.0830	0.750	.0645	PDP-12-4T	PDP-17T
2.0830	0.760	.0645	PD-9-4	PD-16
2.0830	0.760	.0645	PDP-9-4	PDP-16
2.0830	0.760	.0645	PDP-9-4T	PDP-16T
2.0872	0.723	.0865	OP-5-3	OP-5
2.0887	0.591	.0652	C-4-5	C-4
2.0887	0.685	.0652	C-4-5A	C-4A
2.0888	0.688	.0646	O-6-5	O-6, O-7
2.0888	0.688	.0646	O-6-5B	O-6B
2.0900	0.625	.1091	CH-18-1R8	CH-18R8
2.0900	0.625	.1091	CH-18-4R8	CH-18R8

*Denotes (OHC) Repair Bearing, Check "Aluminum Overhead Cam Accessories" Section For Tool Information

**Denotes Auxiliary / Balance Shaft Bearing

"und" Denotes Undersized ID

BEARING COMPONENT PROGRESSIVE LISTING BY HOUSING BORE

HOUSING BORE	LENGTH	MAX WALL	CONTENTS	IN SET(S)
2.0930	0.750	.0695	PDP-12-4R1	PDP-17R1
2.0970	0.723	.0889	OP-3-2	OP-3, OP-5
2.0975	0.937	.0642	CH-3-4	CH-3
2.0975	0.937	.0644	CH-2-2	CH-2
2.0990	0.610	.0653	PD-28-3	PD-28
2.0990	0.610	.0653	PD-28-3B	PD-28B
2.0990	0.615	.0645	PD-25-3	PD-25
2.0990	0.615	.0645	PDP-25-3	PDP-25
2.0990	0.615	.0645	PDP-25-3T	PDP-25T
2.0990	0.625	.0640	PD-21-3	PD-21
2.0990	0.669	.0645	PD-12-3	PD-17
2.0990	0.669	.0645	PDP-12-3	PDP-17
2.0990	0.669	.0645	PDP-12-3T	PDP-17T
2.0990	0.750	.0645	PD-13-3	PD-18
2.0990	0.760	.0645	PD-9-3	PD-16
2.0990	0.760	.0645	PDP-9-3	PDP-16
2.0990	0.760	.0645	PDP-9-3T	PDP-16T
2.0990	0.875	.0649	PD-1-2	PD-1
2.0990	1.062	.0650	PD-3-2	PD-3
2.1069	0.950	.0889	OP-3-1	OP-3, OP-5
2.1087	0.591	.0652	C-4-4	C-4, C-4A
2.1088	0.688	.0646	O-6-4	O-6, O-7, O-8
2.1088	0.688	.0646	O-6-4B	O-6B
2.1090	0.669	.0695	PDP-12-3R1	PDP-17R1
2.1140	0.610	.0653	PD-28-2	PD-28
2.1140	0.610	.0653	PD-28-2B	PD-28B
2.1140	0.625	.0640	PD-21-2	PD-21
2.1140	0.625	.0645	PD-25-2	PD-25, PD-27
2.1140	0.625	.0645	PDP-25-2	PDP-25
2.1140	0.625	.0645	PDP-25-2T	PDP-25T
2.1140	0.750	.0645	PD-12-2	PD-17, PD-18
2.1140	0.750	.0645	PDP-12-2	PDP-17
2.1140	0.750	.0645	PDP-12-2T	PDP-17T
2.1140	0.760	.0645	PD-9-2	PD-16
2.1140	0.760	.0645	PDP-9-2	PDP-16
2.1140	0.760	.0645	PDP-9-2T	PDP-16T
2.1183	0.825	.0595	NIG-1-2	NIG-1**
2.1200	0.755	.0841	GMP-1-1	GMP-1
2.1200	0.755	.0841	GMP-1-1T	GMP-1T
2.1200	0.755	.0841	GMP-2-1T	GMP-2T
2.1200	0.980	.0841	CH-12-3	CH-9A, CH-12, GM-12
2.1200	0.980	.0841	CH-12-3B	CH-12B
2.1200	0.980	.0841	CH-12-3LT	GMP-12LT
2.1200	0.980	.0841	CHP-12-3	CHP-12, GMP-12
2.1200	0.980	.0841	CHP-12-3T	CHP-12T, GMP-12T
2.1240	0.750	.0695	PDP-12-2R1	PDP-17R1
2.1245	0.875	.0615	BU-1-2	BU-2
2.1245	1.125	.0615	BU-1-1	BU-2
2.1250	0.880	.0605	WA-8-2	WA-8, WA-12
2.1250	0.880	.0641	GM-5-3	GM-5
2.1250	1.067	.0605	WA-8-1	WA-8, WA-12
2.1250	1.685	.0644	CU-5-2A	CU-5A, CU-10
2.1255	0.628	.0595	NIG-1-1	NIG-1**
2.1260	0.625	.0620	N-8-5	N-9
2.1260	0.690	.0620	N-7-4	N-7, N-7B, N-10

*Denotes (OHC) Repair Bearing, Check "Aluminum Overhead Cam Accessories" Section For Tool Information

**Denotes Auxiliary / Balance Shaft Bearing

"und" Denotes Undersized ID

BEARING COMPONENT PROGRESSIVE LISTING BY HOUSING BORE

HOUSING BORE	LENGTH	MAX WALL	CONTENTS	IN SET(S)
2.1260	0.690	.0625	N-7-4X001	N-7BW
2.1260	0.750	.0620	H-5-4	H-5
2.1274	0.866	.0797	IZ-5-2	IZ-5
2.1274	0.984	.0797	IZ-5-1	IZ-5
2.1287	0.591	.0652	C-4-3	C-4, C-4A
2.1288	0.688	.0641	O-5-1	O-5
2.1288	0.688	.0646	O-6-3	O-6, O-7, O-8
2.1288	0.688	.0646	O-6-3B	O-6B
2.1290	2.250	.0644	CU-1-1	CU-5A, CU-10
2.1295	1.093	.0645	PD-1-1	PD-1, PD-3
2.1300	0.750	.0645	PD-17-1	PD-17
2.1300	0.750	.0645	PDP-17-1	PDP-17
2.1300	0.750	.0645	PDP-17-1T	PDP-17T
2.1300	0.780	.0640	PD-21-1	PD-21
2.1300	0.813	.0647	PD-8-2	PD-8
2.1300	0.875	.0645	PD-16-1	PD-16, PD-25, PD-27
2.1300	0.875	.0645	PDP-16-1	PDP-16, PDP-25
2.1300	0.875	.0645	PDP-16-1T	PDP-16T, PDP-25T
2.1300	0.920	.0645	PD-18-1	PD-18
2.1300	0.930	.0647	PD-28-1	PD-28, PD-28B
2.1300	0.938	.0647	PD-8-1	PD-8
2.1300	0.980	.0891	CH-12-2	CH-9A, CH-12
2.1300	0.980	.0891	CH-12-2B	CH-12B
2.1300	0.980	.0891	CHP-12-2	CHP-12
2.1300	0.980	.0891	CHP-12-2T	CHP-12T
2.1300	0.980	.0894	CH-9-4	CH-9A
2.1339	0.537	.0620	F-48-2	F-48, F-48A
2.1360	0.625	.0670	N-8-51	N-9R1
2.1360	0.690	.0620	N-7-3	N-7, N-10
2.1360	0.690	.0620	N-7-3B	N-7B
2.1360	0.690	.0625	N-7-3BX001	N-7BW
2.1360	0.750	.0620	H-5-3	H-5
2.1365	1.000	.0624	F-25-1	F-25
2.1400	0.750	.0695	PDP-17-1R1	PDP-17R1
2.1400	0.860	.0941	CH-12-1	CH-9A, CH-12
2.1400	0.860	.0941	CH-12-1B	CH-12B
2.1400	0.860	.0941	CHP-12-1	CHP-12
2.1400	0.860	.0941	CHP-12-1T	CHP-12T
2.1408	0.740	.0695	OG-1-1	OG-1**
2.1420	0.775	.0655	GM-7-5	GM-7, GM-7R2
2.1430	0.815	.0701	FG-1-1	FG-1-1**
2.1440	0.660	.0602	F-18-5	F-18, F-26
2.1440	0.660	.0602	FP-18-5	FP-18, FP-26
2.1440	0.660	.0602	FP-18-5T	FP-18T, FP-26T
2.1445	0.860	.0624	F-23-1A	F-23A
2.1445	0.860	.0624	F-23-1B	F-23B, F-49B
2.1445	0.860	.0624	F-49-2	F-49
2.1460	0.690	.0620	N-7-2	N-7, N-10
2.1460	0.690	.0620	N-7-2B	N-7B
2.1460	0.690	.0625	N-7-2BX001	N-7BW
2.1460	0.750	.0620	H-5-2	H-5
2.1487	0.591	.0652	C-4-2	C-4, C-4A
2.1488	0.688	.0646	O-6-2	O-6, O-7, O-8
2.1488	0.688	.0646	O-6-2B	O-6B
2.1500	0.860	.0991	CHP-12-11	CHP-12R1

*Denotes (OHC) Repair Bearing, Check "Aluminum Overhead Cam Accessories" Section For Tool Information

**Denotes Auxiliary / Balance Shaft Bearing

"und" Denotes Undersized ID

BEARING COMPONENT PROGRESSIVE LISTING BY HOUSING BORE

HOUSING BORE	LENGTH	MAX WALL	CONTENTS	IN SET(S)
2.1500	0.980	.0991	CHP-12-21	CHP-12R1
2.1536	0.537	.0719	F-48-4	F-48
2.1536	0.537	.0719	F-48-4A	F-48A
2.1536	0.955	.0719	F-48-1	F-48, F-48A
2.1560	0.625	.0620	N-8-4	N-9
2.1560	0.690	.0620	N-7-1	N-7, N-7B
2.1560	0.690	.0620	N-10-1	N-10
2.1560	0.690	.0625	N-7-1X001	N-7BW
2.1560	0.750	.0620	H-5-1	H-5
2.1562	0.880	.0641	GM-5-2	GM-5
2.1565	0.630	.0646	CH-24-2	CH-24
2.1590	0.660	.0602	F-18-4	F-18, F-26
2.1590	0.660	.0602	FP-18-4	FP-18, FP-26
2.1590	0.660	.0602	FP-18-4T	FP-18T, FP-26T
2.1590	0.860	.0695	F-49-1	F-49
2.1590	0.860	.0695	F-49-1B	F-49B
2.1595	0.625	.0650	PD-30-5	PD-30
2.1599	1.125	.0644	CH-2-1	CH-2
2.1600	0.860	.1041	CHP-12-12	CHP-12R2
2.1600	0.937	.0641	CH-3-3	CH-3
2.1600	0.980	.1041	CHP-12-22	CHP-12R2
2.1660	0.625	.0670	N-8-41	N-9R1
2.1687	0.591	.0652	C-4-1	C-4, C-4A
2.1688	0.688	.0646	O-6-1	O-6
2.1688	0.688	.0646	O-6-1B	O-6B
2.1688	0.688	.0646	O-7-1	O-7, O-8
2.1740	0.660	.0602	F-18-3	F-18, F-26
2.1740	0.660	.0602	FP-18-3	FP-18, FP-26
2.1740	0.660	.0602	FP-18-3T	FP-18T, FP-26T
2.1755	0.625	.0650	PD-30-4	PD-30
2.1766	0.620	.0747	CH-24-3	CH-24
2.1766	0.905	.0747	CH-24-1	CH-24
2.1770	0.555	.0619	F-45-2	F-45
2.1770	0.555	.0619	F-51-2	F-38, F-52
2.1770	0.595	.0613	F-51-2X	F-38X
2.1860	0.625	.0620	N-8-3	N-9
2.1862	0.812	.0653	HE-1-2A	HE-8A
2.1862	1.057	.0653	HE-7-1A	HE-8A
2.1870	0.905	.0932	CU-11-2	CU-11, CU-11A
2.1870	1.905	.0932	CU-11-1	CU-11, CU-11A
2.1870	2.255	.0643	WA-9-3	WA-9
2.1875	0.812	.0660	HE-1-2	HE-1, HE-7, HE-8
2.1875	1.057	.0658	HE-7-1	HE-7, HE-8
2.1875	1.125	.0660	HE-1-1	HE-1
2.1875	1.680	.0641	GM-5-1	GM-5
2.1880	1.180	.1052	CAT-2-5	CAT-2-5
2.1880	2.000	.1052	CAT-2-6	CAT-2-6
2.1890	0.660	.0602	F-18-2	F-18, F-26
2.1890	0.660	.0602	FP-18-2	FP-18, FP-26
2.1890	0.660	.0602	FP-18-2T	FP-18T, FP-26T
2.1890	0.723	.0894	F-46-2	F-46
2.1913	0.750	.0647	IN-11-5	IN-11
2.1915	0.625	.0650	PD-30-3	PD-30
2.1920	0.635	.0688	F-52-1X	F-38X
2.1920	0.635	.0694	AGB-51-1	F-38, F-38X, FG-51**

*Denotes (OHC) Repair Bearing, Check "Aluminum Overhead Cam Accessories" Section For Tool Information

**Denotes Auxiliary / Balance Shaft Bearing

"und" Denotes Undersized ID

BEARING COMPONENT PROGRESSIVE LISTING BY HOUSING BORE

HOUSING BORE	LENGTH	MAX WALL	CONTENTS	IN SET(S)
2.1920	0.635	.0694	F-45-1	F-45
2.1920	0.635	.0694	F-52-1	F-38, F-52
2.1960	0.625	.0670	N-8-31	N-9R1
2.2007	1.062	.0647	IN-8-3	IN-12, IN-14
2.2008	1.062	.0645	IN-2-3	IN-3
2.2010	1.060	.0645	IN-16-3	IN-16
2.2013	0.645	.0647	IN-11-4	IN-11
2.2040	0.660	.0602	351HP-1	351HP, 351RHP
2.2040	0.660	.0602	351HP-1T	351HPT, 351RHPT
2.2040	0.660	.0602	351-HPB-1T	SBF-1T
2.2040	0.660	.0602	F-18-1	F-18
2.2040	0.660	.0602	FP-18-1	FP-18
2.2040	0.660	.0602	FP-18-1T	FP-18T
2.2040	0.660	.0677	351HP-2	351HP
2.2040	0.660	.0677	351HP-2T	351HPT
2.2040	0.660	.0677	351-HPB-2T	SBF-1T
2.2040	0.660	.0752	351HP-3	351HP
2.2040	0.660	.0752	351HP-3T	351HPT
2.2040	0.660	.0752	351-HPB-3T	SBF-1T
2.2040	0.660	.0827	351HP-4	351HP
2.2040	0.660	.0827	351HP-4T	351HPT
2.2040	0.660	.0827	351-HPB-4T	SBF-1T
2.2040	0.660	.0902	351HP-5	351HP
2.2040	0.660	.0902	351HP-5T	351HPT
2.2040	0.660	.0902	351-HPB-5T	SBF-1T
2.2047	0.503	.0973	F-46-3	F-46
2.2047	0.723	.0973	F-46-1	F-46
2.2047	0.787	.0594	TO-15-3	TO-15
2.2047	0.787	.0644	TO-15-4	TO-15
2.2075	0.625	.0652	PD-30-2	PD-30
2.2113	0.645	.0647	IN-11-3	IN-11
2.2140	0.660	.0652	351HP-1R1	351HP-R1
2.2140	0.660	.0652	351-HPB-1R1T	SBF-1R1T
2.2140	0.660	.0727	351HP-2R1	351HP-R1
2.2140	0.660	.0727	351-HPB-2R1T	SBF-1R1T
2.2140	0.660	.0802	351HP-3R1	351HP-R1
2.2140	0.660	.0802	351-HPB-3R1T	SBF-1R1T
2.2140	0.660	.0877	351HP-4R1	351HP-R1
2.2140	0.660	.0877	351-HPB-4R1T	SBF-1R1T
2.2140	0.660	.0952	351HP-5R1	351HP-R1
2.2140	0.660	.0952	351-HPB-5R1T	SBF-1R1T
2.2146	0.787	.0742	TO-15-5	TO-15
2.2160	0.625	.0620	N-8-2	N-9
2.2207	1.062	.0647	IN-8-2	IN-3, IN-12, IN-14, IN-16
2.2213	0.645	.0647	IN-11-2	IN-11
2.2225	0.937	.0641	CH-3-2	CH-3
2.2235	0.885	.0650	PD-30-1	PD-30
2.2260	0.625	.0670	N-8-21	N-9R1
2.2313	0.650	.0647	IN-17-2	IN-17
2.2313	0.710	.0647	IN-11-1	IN-11
2.2313	0.785	.0647	IN-17-1	IN-17
2.2408	1.125	.0647	IN-3A-1	IN-3, IN-12, IN-14
2.2460	0.920	.0620	N-9-1	N-9
2.2493	1.469	.0642	IN-5-2	IN-5
2.2495	1.000	.0940	CO-7-3	CO-7

*Denotes (OHC) Repair Bearing, Check "Aluminum Overhead Cam Accessories" Section For Tool Information

**Denotes Auxiliary / Balance Shaft Bearing

"und" Denotes Undersized ID

BEARING COMPONENT PROGRESSIVE LISTING BY HOUSING BORE

HOUSING BORE	LENGTH	MAX WALL	CONTENTS	IN SET(S)
2.2495	1.760	.1243	MAG-10-2	MAG-10**
2.2500	0.560	.0616	F-15-5	F-33
2.2500	0.560	.0616	FP-15-5	FP-33
2.2500	0.560	.0616	FP-15-5T	FP-33T
2.2500	0.560	.0619	F-24-5	F-24
2.2500	0.580	.0618	F-30-1	F-30
2.2500	0.580	.0618	FP-30-1	FP-30
2.2500	0.580	.0618	FP-30-1T	FP-30T
2.2500	0.660	.0616	F-26-1	F-26
2.2500	0.660	.0616	FP-26-1	FP-26
2.2500	0.660	.0616	FP-26-1T	FP-26T, FP-30AT
2.2500	0.755	.0618	F-11-2	F-11, F-12
2.2500	0.855	.0620	GM2125-1	GMP-3
2.2500	0.855	.0620	GM2125-1T	GMP-3T
2.2500	0.875	.0618	F-8-1	F-11, F-12
2.2500	0.980	.0620	GM2125-4	GMP-3
2.2500	0.980	.0620	GM2125-4T	GMP-3T
2.2500	1.250	.0614	WA-2-1	WA-10
2.2505	1.545	.0925	DE-1-1	DE-1
2.2513	0.650	.0768	IN-17-2S	IN-17R2
2.2513	0.785	.0768	IN-17-1S	IN-17R2
2.2535	1.005	.0620	CU-12-1	CU-12
2.2539	0.787	.0791	TO-15-2	TO-15
2.2540	1.125	.0643	WA-3-1	WA-3
2.2550	0.580	.0645	FP-30-1R	FP-30R
2.2560	0.920	.0670	N-9-11	N-9R1
2.2595	1.000	.0630	A-3-2	A-3, A-4, A-5
2.2595	1.385	.0630	A-3-1	A-3, A-4, A-5
2.2600	0.580	.0668	F-30-1R1	F-30R1
2.2638	0.787	.0791	TO-15-1	TO-15
2.2650	0.620	.0691	F-15-4	F-33
2.2650	0.620	.0691	FP-15-4	FP-33
2.2650	0.620	.0691	FP-15-4T	FP-33T
2.2650	0.620	.0694	F-24-4	F-24
2.2650	0.625	.0694	F-30-1S	F-57
2.2700	0.580	.0718	F-30-1R2	F-30R2
2.2776	1.185	.0946	CAT-2-3	CAT-2-3
2.2776	2.000	.0946	CAT-2-4	CAT-2-4
2.2800	0.620	.0766	F-15-3	F-33
2.2800	0.620	.0766	FP-15-3	FP-33
2.2800	0.620	.0766	FP-15-3T	FP-33T
2.2800	0.620	.0769	F-24-3	F-24
2.2820	0.785	.0569	GMP-55-1	GMP-55
2.2820	0.785	.0569	GMP-55-1T	GMP-55T
2.2850	1.125	.0641	CH-3-1	CH-3
2.2950	0.620	.0841	F-15-2	F-33
2.2950	0.620	.0841	FP-15-2	FP-33
2.2950	0.620	.0841	FP-15-2T	FP-33T
2.2950	0.620	.0844	F-24-2	F-24
2.2990	0.775	.0653	GM-7-4	GM-7
2.3088	0.630	.0700	CH-10-3	CH-10, CH-23, GM-9
2.3088	0.630	.0700	CHP-10-3	CHP-10, CHP-23, GMP-9
2.3088	0.630	.0700	CHP-10-3T	CHP-10T, CHP-23T, GMP-9T
2.3088	0.775	.0700	CH-25-3	CH-25, GM-25
2.3088	0.775	.0700	CHP-25-3	CHP-25, GMP-25

*Denotes (OHC) Repair Bearing, Check "Aluminum Overhead Cam Accessories" Section For Tool Information

**Denotes Auxiliary / Balance Shaft Bearing

"und" Denotes Undersized ID

BEARING COMPONENT PROGRESSIVE LISTING BY HOUSING BORE

HOUSING BORE	LENGTH	MAX WALL	CONTENTS	IN SET(S)
2.3088	0.775	.0700	CHP-25-3T	CHP-25T, GMP-25T
2.3090	0.775	.0703	GM-7-3	GM-7
2.3095	0.760	.0912	FP-01-1	FP-01
2.3095	0.760	.0912	FP-01-2	FP-01
2.3095	0.760	.0912	FP-01-4	FP-01
2.3100	0.620	.0912	F-33-1	F-24, F-33
2.3115	1.750	.1235	MAG-11-1	MAG-11**
2.3115	1.760	.1237	MAG-10-1	MAG-10**
2.3120	1.000	.0940	CO-7-2	CO-7
2.3120	1.250	.0610	R-1-3	R-1
2.3165	1.125	.0645	J-1-1	J-1
2.3171	0.630	.0740	CH-10-2	CH-10
2.3171	0.630	.0740	CHP-10-2	CHP-10
2.3171	0.630	.0740	CHP-10-2T	CHP-10T
2.3190	0.775	.0753	GM-7-2	GM-7
2.3200	0.760	.0962	FP-01-1R1	FP-01R1
2.3200	0.760	.0962	FP-01-2R1	FP-01R1
2.3200	0.760	.0962	FP-01-4R1	FP-01R1
2.3270	0.630	.0790	CH-10-1	CH-10, CH-23
2.3270	0.630	.0790	CHP-10-1	CHP-10, CHP-23
2.3270	0.630	.0790	CHP-10-1T	CHP-10T, CHP-23T
2.3280	0.895	.0798	GM-7-1	GM-7
2.3285	0.775	.0799	CH-25-2	CH-25
2.3285	0.775	.0799	CHP-25-2	CHP-25
2.3285	0.775	.0799	CHP-25-2T	CHP-25T
2.3323	1.005	.1010	CU-14-1	CU-14
2.3470	0.630	.0890	CH-23-1	CH-23
2.3470	0.630	.0890	CHP-23-1	CHP-23
2.3470	0.630	.0890	CHP-23-1T	CHP-23T
2.3480	0.775	.0898	GM-7-2R2	GM-7R2
2.3480	0.895	.0898	GM-7-1R2	GM-7R2
2.3482	0.775	.0890	CH-25-1	CH-25
2.3482	0.775	.0890	CHP-25-1	CHP-25
2.3482	0.775	.0890	CHP-25-1T	CHP-25T
2.3533	0.710	.0728	PDG-30-1	PDG-30**
2.3555	1.505	.0844	DE-2-3	DE-7
2.3637	0.787	.0785	IZ-6-1	IZ-6, IZ-7, IZ-8
2.3637	0.787	.0785	IZ-6-2	IZ-6, IZ-7, IZ-8
2.3655	1.505	.0900	DE-2-2	DE-2, DE-2A, DE-5, DE-7
2.3743	1.094	.0940	CO-7-1	CO-7
2.3745	1.156	.0625	CA-6-3	CA-6, CA-7
2.3745	1.437	.0625	CA-6-2	CA-6, CA-7
2.3745	1.656	.0625	CA-6-1	CA-6, CA-7
2.3748	1.000	.0618	IN-10-4A	IN-10A
2.3748	1.438	.0644	IN-5-1	IN-5
2.3755	1.505	.0943	DE-2-1	DE-2, DE-2A, DE-5, DE-7
2.3755	1.505	.0943	DE-2-2R1	DE-2R1, DE-2AR1, DE-5R1
2.3758	0.587	.0650	PD-31-4B	PD-31B
2.3758	0.587	.0655	PD-31-4W	PD-31BW
2.3855	1.505	.0993	DE-2-1R1	DE-2R1, DE-2AR1, DE-5R1
2.3880	0.710	.0610	F-14-5	F-19
2.3916	0.587	.0650	PD-31-3B	PD-31B
2.3916	0.587	.0655	PD-31-3W	PD-31BW
2.4030	0.710	.0609	F-19-4	F-19
2.4073	0.587	.0650	PD-31-2B	PD-31B

*Denotes (OHC) Repair Bearing, Check "Aluminum Overhead Cam Accessories" Section For Tool Information

**Denotes Auxiliary / Balance Shaft Bearing

"und" Denotes Undersized ID

BEARING COMPONENT PROGRESSIVE LISTING BY HOUSING BORE

HOUSING BORE	LENGTH	MAX WALL	CONTENTS	IN SET(S)
2.4073	0.587	.0655	PD-31-2W	PD-31BW
2.4125	0.680	.0643	CH-13-1	CH-13
2.4125	0.680	.0643	CH-13-2	CH-13
2.4153	1.000	.0613	IN-10-3	IN-10A
2.4180	0.710	.0609	F-19-3	F-19
2.4231	0.665	.0650	PD-31-1B	PD-31B
2.4231	0.665	.0655	PD-31-1W	PD-31BW
2.4330	0.710	.0609	F-19-2	F-19
2.4370	1.250	.0610	R-1-2	R-1
2.4413	0.710	.0780	IN-19-4	IN-19
2.4438	1.000	.0625	IN-10-2	IN-10A
2.4480	0.710	.0609	F-19-1	F-19
2.4613	0.709	.0880	IN-19-3	IN-19
2.4748	1.187	.0618	IN-10-1A	IN-10A
2.4813	0.709	.0980	IN-19-2	IN-19
2.4985	0.670	.0629	F-16-2	F-16
2.5000	1.000	.0614	JD-3-1	JD-3, JD-4
2.5013	1.010	.1078	IN-19-1	IN-19
2.5345	0.765	.0708	F-43-1	F-43, F-44, F-55
2.5598	0.705	.0790	GM-8-2	GM-8
2.5598	1.120	.0790	GM-8-1	GM-8
2.5610	1.125	.0645	IN-16-1	IN-16
2.5620	1.625	.0610	R-1-1	R-1
2.5630	1.004	.1243	CAT-2-2	CAT-6, CAT-7
2.5630	1.125	.1243	CAT-2-1	CAT-6, CAT-7
2.5984	0.740	.0778	IN-21-1	IN-21
2.6000	0.755	.0617	F-12-1	F-12
2.6025	0.670	.0629	F-16-1	F-16
2.6235	1.010	.0905	MA-5-2	MA-5
2.6235	1.010	.0910	MA-5-3	MA-5, MA-6, MA-7, MA-8
2.6235	1.380	.1852	MA-3A-1	MA-6
2.6235	1.380	.1853	MA-5-4	MA-5
2.6235	1.385	.0905	MA-8-1	MA-8
2.6235	1.385	.0910	MA-5-1	MA-5, MA-6, MA-7
2.6250	1.500	.0618	WA-11-1	WA-11
2.6525	0.755	.0750	CAT-1-2	CAT-2
2.6870	1.070	.0937	CU-13-2	CU-13
2.6870	1.685	.0939	CU-8-1	CU-9
2.6870	1.685	.0939	CU-9-1	CU-9
2.6870	1.810	.0937	CU-13-1	CU-13
2.6870	2.185	.0939	CU-9-2	CU-9
2.7165	0.750	.0748	CAT-5-1	CAT-5, CAT-8
2.7216	0.705	.0774	DE-4-1	DE-4
2.7559	1.340	.0945	CAT-5-0	CAT-5, CAT-8
2.8735	1.000	.0908	MA-11-1	MA-11
2.8735	1.181	.0908	MA-11-2	MA-11
2.8745	1.185	.1258	CAT-3-1	CAT-3-1
2.8745	1.995	.1256	CAT-3-2	CAT-3-2
2.8750	1.505	.0645	WA-9-2	WA-9
2.8750	1.880	.0645	WA-9-1	WA-9
NA	NA	NA	SH-1798T	CH-17G, CH-21G, CHG-15A**

*Denotes (OHC) Repair Bearing, Check "Aluminum Overhead Cam Accessories" Section For Tool Information

**Denotes Auxiliary / Balance Shaft Bearing

"und" Denotes Undersized ID

SPECIALTY BEARING COMPONENT PROGRESSIVE LISTING BY HOUSING BORE

COMPONENT	MINIMUM HOUSING BORE	LENGTH	MAX. WALL	CAM JOURNAL DIAMETER	COMMENTS
19502L	1.9990	0.740	.0644	1.8692	OD Groove, 3 Oil Holes
19502LT	1.9990	0.740	.0644	1.8692	OD Groove, 3 Oil Holes
BRO-5-3	1.9990	0.860	.0644	1.8692	1 Oil Hole, 1 Pin Hole
19500L	2.1190	0.775	.0841	1.9498	
19501L	2.1190	0.755	.0841	1.9498	OD Groove, 3 Oil Holes
19501LT	2.1190	0.755	.0841	1.9498	OD Groove, 3 Oil Holes
CH-12-3L	2.1190	0.980	.0841	1.9498	OD Groove, 3 Oil Holes
GMP-2-1	2.1190	0.765	.0743	1.9498	
19500LR1	2.1290	0.755	.0891	1.9498	
19501LR1	2.1290	0.755	.0891	1.9498	OD Groove, 3 Oil Holes
CH-12-3LR1	2.1290	0.980	.0891	1.9498	OD Groove, 3 Oil Holes
19500LR2	2.1390	0.755	.0941	1.9498	
19501LR2	2.1390	0.755	.0941	1.9498	OD Groove, 3 Oil Holes
CH-12-3LR2	2.1390	0.980	.0941	1.9498	OD Groove, 3 Oil Holes
19501LR3	2.1490	0.755	.0991	1.9498	OD Groove, 3 Oil Holes
CH-12-3LR3	2.1490	0.980	.0991	1.9498	OD Groove, 3 Oil Holes
GM2125-2	2.2495	0.630	.0620	2.1245	
GM2125-3	2.2495	0.530	.0620	2.1245	
GM2125-11	2.2595	0.855	.0670	2.1245	
GM2125-21	2.2595	0.630	.0670	2.1245	
GM2125-31	2.2595	0.530	.0670	2.1245	
GM2125-41	2.2595	0.980	.0670	2.1245	
GM2125-12	2.2695	0.855	.0720	2.1245	
GM2125-22	2.2695	0.630	.0720	2.1245	
GM2125-32	2.2695	0.530	.0720	2.1245	
GM2125-42	2.2695	0.980	.0720	2.1245	
19500L14	2.2795	0.755	.1644	1.9497	
GM2125-13	2.2795	0.855	.0770	2.1245	
GM2125-43	2.2795	0.980	.0770	2.1245	
GM2132-1	2.2814	0.925	.0739	2.1326	No Oil Hole
GM2132-2	2.2814	1.075	.0739	2.1326	No Oil Hole
60215-P	2.2830	0.775	.0569	2.1663	OD Groove, 3 Oil Holes
GM-55-1	2.2830	0.785	.0575	2.1665	OD Groove, 3 Oil Holes
BRG60115	2.2980	1.000	.0653	2.1664	OD Groove, 3 Oil Holes
GM2300-1	2.2980	0.775	.0653	2.1664	OD Groove, 3 Oil Holes
GM2300-1T	2.2980	0.775	.0653	2.1664	OD Groove, 3 Oil Holes
GM2300-1R1	2.3080	0.775	.0703	2.1663	OD Groove, 3 Oil Holes
GM2300-1R2	2.3180	0.775	.0753	2.1663	OD Groove, 3 Oil Holes
GM2319-1	2.3180	0.775	.0753	2.1664	OD Groove, 3 Oil Holes
PN2250-1	2.4790	0.750	.0575	2.3630	OD Groove, No Oil Hole
GM-60-1	2.4791	0.750	.0572	2.3620	OD Groove, 3 Oil Holes
GM-60-1A	2.4791	0.750	.0577	2.3620	
GM-60-1W	2.4791	0.750	.0567	2.3620	
60040	2.5000	0.775	.0675	2.3620	
CN-1-1	2.5020	0.780	.0704	2.3622	60mm
60220	2.6745	0.805	.0557	2.5595	

*Denotes (OHC) Repair Bearing, Check "Aluminum Overhead Cam Accessories" Section For Tool Information

**Denotes Auxiliary / Balance Shaft Bearing

"und" Denotes Undersized ID

OPTIMUM PLACEMENT OF CAMSHAFT BEARING OIL FEED HOLE LOCATION

Maximum camshaft support will be realized by installing the cam bearing oil feed hole to the optimum clock location. Blocks and heads using a 360° oil groove located behind the bearing oil feed, allow one to move the clock position of the cam bearing oil feed hole. This way you can adjust the clock position during cam bearing installation to make sure that the optimum location for the best hydrodynamic wedge is selected. Locating and installing the cam bearing to take advantage of this hydrodynamic wedge will supply the maximum support for the camshaft during engine operation. The direction of camshaft rotation and the engine oil entry point into the bearing control the placement of the hydrodynamic wedge.

If the oil feed passage in the block or head is just a hole without a 360° groove, the bearing oil hole must line up with the oil feed passage in the block or head. In some instances, the bearing oil feed hole in the cam bearing also lines up with a groove cut in the camshaft journal. In those instances, the location of the bearing oil feed hole in the bearing is also very critical fore and aft and may not match up 100% with the hole in the block or head.

If the camshaft being used is driven with a gear-to-gear arrangement, or is a reverse rotation engine with a chain drive, the cam bearing oil feed hole will require repositioning to the opposite lower side. This is due to the fact that the camshaft is turning in the opposite direction.

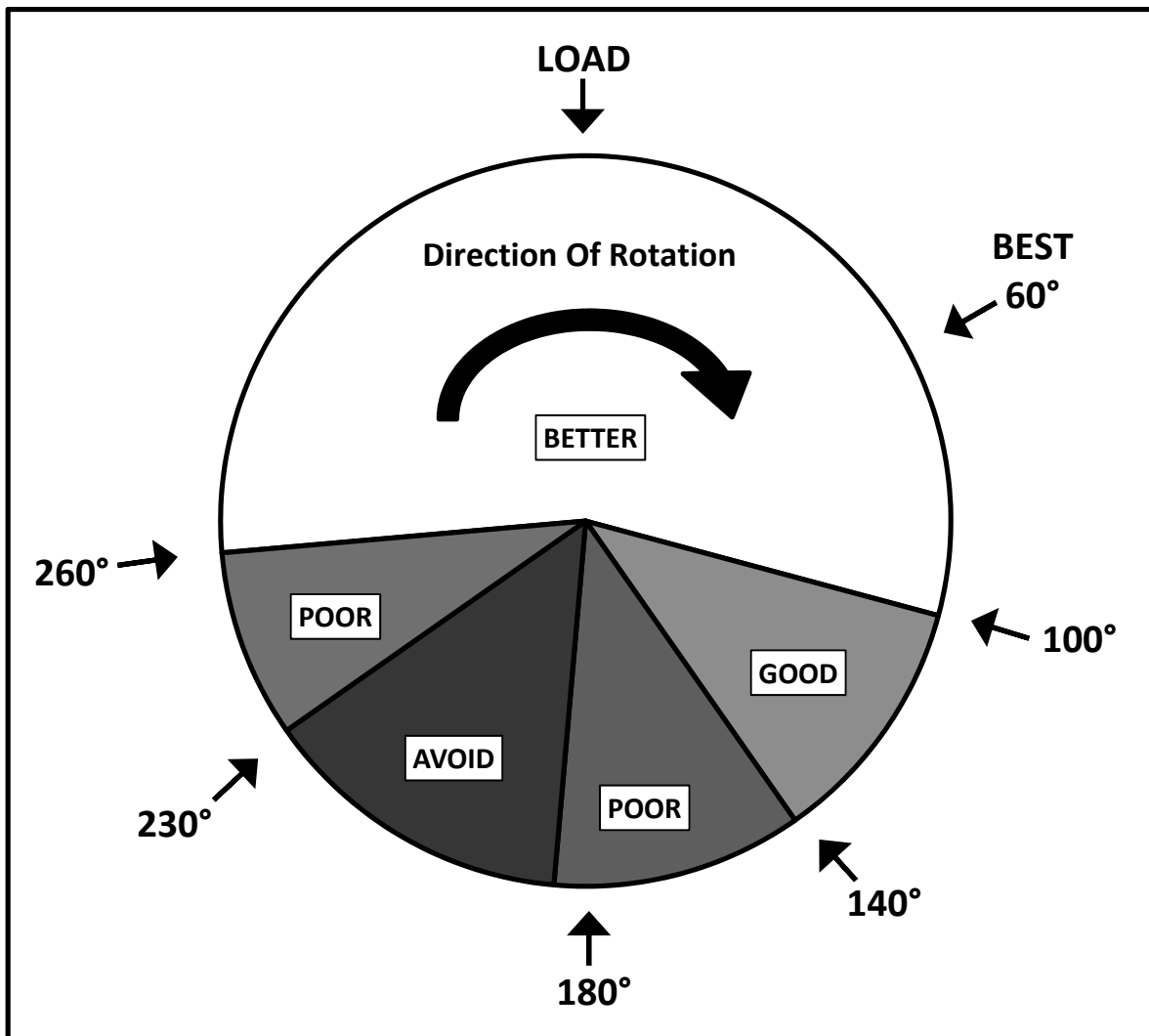

(The illustration shows the optimum engine oil feed hole location for a camshaft that is turning clockwise as viewed from the front of the engine.)

CONVERSION SIZE CHART

INCHES		MILLIMETERS	INCHES		MILLIMETERS
(FRACTION)	(DECIMAL)	(MM)	(FRACTION)	(DECIMAL)	(MM)
1/64	0.0156	0.3969	33/64	0.5156	13.0969
1/32	0.0313	0.7938	17/32	0.5313	13.4938
3/64	0.0469	1.1906	35/64	0.5469	13.8906
1/16	0.0625	1.5875	9/16	0.5625	14.2875
5/64	0.0781	1.9844	37/64	0.5781	14.6844
3/32	0.0938	2.3813	19/32	0.5938	15.0813
7/64	0.1094	2.7781	39/64	0.6094	15.4781
1/8	0.1250	3.1750	5/8	0.6250	15.8750
9/64	0.1406	3.5719	41/64	0.6406	16.2719
5/32	0.1563	3.9688	21/32	0.6563	16.6688
11/64	0.1719	4.3656	43/64	0.6719	17.0656
3/16	0.1875	4.7625	11/16	0.6875	17.4625
13/64	0.2031	5.1594	45/64	0.7031	17.8594
7/32	0.2188	5.5563	23/32	0.7188	18.2563
15/64	0.2344	5.9531	47/64	0.7344	18.6531
1/4	0.2500	6.3500	3/4	0.7500	19.0500
17/64	0.2656	6.7469	49/64	0.7656	19.4469
9/32	0.2813	7.1438	25/32	0.7813	19.8438
19/64	0.2969	7.5406	51/64	0.7969	20.2406
5/16	0.3125	7.9375	13/16	0.8125	20.6375
21/64	0.3281	8.3344	53/64	0.8281	21.0344
11/32	0.3438	8.7313	27/32	0.8438	21.4313
23/64	0.3594	9.1281	55/64	0.8594	21.8281
3/8	0.3750	9.5250	7/8	0.8750	22.2250
25/64	0.3906	9.9219	57/64	0.8906	22.6219
13/32	0.4063	10.3188	29/32	0.9063	23.0188
27/64	0.4219	10.7156	59/64	0.9219	23.4156
7/16	0.4375	11.1125	15/16	0.9375	23.8125
29/64	0.4531	11.5094	61/64	0.9531	24.2094
15/32	0.4688	11.9063	31/32	0.9688	24.6063
31/64	0.4844	12.3031	63/64	0.9844	25.0031
1/2	0.5000	12.7000	1	1.0000	25.4000

CONVERSION FORMULA

INCHES X 25.4 = MM

MM / 25.4 = INCHES

BEARING COMPETITIVE INTERCHANGES

ACL - DURA-BOND BEARING SETS							
ACL	DURA-BOND	ACL	DURA-BOND	ACL	DURA-BOND	ACL	DURA-BOND
10SC6005S	GMA-2	4C1002BS	F-47B	4C652S	F-43	5C369S	F-16
1BS1400S	CHG-15A	4C1002S	F-47	4C654S	F-31	5C4146	DA-1
1C069S	J-1	4C1031BS	B-12B	4C690S	CA-8	5C426S	IN-11
1C1094S	FG-29	4C1031S	B-12	4C703S	F-32	5C510S	F-18
1C330S	WA-4	4C1089S	CH-17	4C718S	CH-11	5C514S	HO-2
1C4096	BL-1	4C1102S	CH-18	4C777BS	F-34B	5C530S	C-3
2BS1403S	PDG-29S	4C1102SW	CH-18A	4C777S	F-34	5C559S	F-9A
2BS1445S	FG-51	4C1114S	PD-27	4C7936	VO-3	5C6003S	FA-1
2BS8078	TOG-9	4C1115S	PD-21	4C7979	TO-10	5C6004S	GMA-1
2BS8286	TOG-8	4C1197S	F-45	4C8066	TO-3	5C615S	CH-9A
2C026S	PDG-26	4C1246C	BP-13	4C8076	TO-8	5C616S	CH-12
2C1095S	FG-34	4C1246S	B-13	4C874S	PD-18	5C638S	O-6
2C1209S	VWG-1	4C1247S	O-8	5C004AS	CH-4A	5C643S	F-24
2C6002S	FG-53	4C1251S	F-46	5C1000S	CH-10	5C653S	F-44
3BS8387	MIG-3	4C1254BS	F-49B	5C1001S	CH-23	5C671S	N-9
3C021S	F-1	4C1254S	F-49	5C1004S	PDA-3	5C679S	B-11
3C023S	PD-1	4C1351S	CH-21	5C1088S	O-7	5C680S	B-9
3C056S	CO-8	4C1405BS	PD-28B	5C1092S	IN-17	5C710C	FP-26
3C1030S	CH-16	4C1405S	PD-28	5C1111S	F-30	5C710S	F-26
3C1190S	CHG-14	4C1441AS	F-50A	5C1112S	PD-25	5C716S	CH-13
3C1305S	CH-20	4C1441S	F-50	5C1191S	CA-9	5C781S	F-33
3C191S	CO-3	4C1447S	F-52	5C1195S	CH-19	5C7969	TO-11
3C400S	CH-6	4C1812S	B-14	5C1199S	GM-7	5C8045	TO-12
3C4018	DA-2	4C190S	K-1	5C1300S	C-4	5C8186	TO-7
3C4036	DA-3A	4C209S	CH-2	5C1300SW	C-4A	5C8217	TO-15
3C502S	CA-3	4C220S	IN-14	5C1319S	F-9B	5C875S	PD-16
3C507S	IN-18	4C3088	HO-3	5C1321S	FP-18	5C876S	PD-17
3C6007	VO-2	4C383S	CH-3	5C1763S	351RHP	5SC6006	MZA-4
3C711S	F-28	4C399S	CH-7	5C277S	C-2	5SC761	MIA-1
3C733S	F-29	4C4036S	DA-5	5C287S	CH-4	6BS8033	MZG-3
3C8071	TO-14	4C506S	B-6	5C290S	CH-8	6C1100S	FA-3
3C8074	TO-13	4C533S	F-22	5C291S	P-3	6C1200S	FA-4
3C8127	IZ-3	4C534S	F-7	5C292S	P-4	6C1201S	FA-5
3C8276S	F-41	4C549BS	N-7B	5C324S	O-5	6C1300S	PD-30
3C8288S	MIG-2	4C549S	N-7	5C3346C	GMP-8	6C8454	IZ-8
4BS8000	TOG-10	4C567BS	F-23B	5C3349C	CHP-8		
4C048AS	F-48A	4C567S	F-23A	5C343S	F-12		
4C048S	F-48	4C6001S	CHG-22	5C361S	B-8		

MAHLE / CLEVITE - DURA-BOND BEARING SETS							
CLEVITE	DURA-BOND	CLEVITE	DURA-BOND	CLEVITE	DURA-BOND	CLEVITE	DURA-BOND
SH1006S	F-54	SH1115S	PD-21	SH1254S	F-49	SH1360S	B-11
SH1011S	DB-1	SH1119S	NI-1	SH1305S	CH-20	SH1361S	B-9
SH1017S	F-53	SH1131S	MZ-1	SH1321S	FP-18	SH1364S	CH-18
SH1030S	CH-16	SH1155S	MI-1	SH1326S	PDG-26	SH1364S80	CH-18R8
SH1060S	TO-10	SH116S	IN-5	SH1328S	WA-12	SH1365S	CH-19
SH1065S	TO-11	SH1190S	CHG-14	SH1329S	WA-8	SH1366S	GM-7
SH1066S	F-41	SH1191S	CA-9	SH1349S	CHP-8	SH1371S	C-4
SH1092S	IN-17	SH1193S	OP-5	SH1350S	CH-17	SH1382S	CU-13
SH1094S	FG-29	SH1197S	F-45	SH1351S	CH-21	SH1385S	B-12
SH1095S	FG-34	SH1209S	VWG-1	SH1352S	CH-4A	SH1386S	F-31
SH1111S	F-30	SH1245S	CAT-2	SH1354S	O-6	SH1390S	F-47
SH1112S	PD-25	SH1248S	TO-13	SH1355S	O-7	SH1394S	CU-11
SH1114S	PD-27	SH1251S	F-46	SH1356S	O-8	SH1395S	CU-11A

Reference interchange only. Check manufacture specifications prior to installation.

BEARING COMPETITIVE INTERCHANGES

MAHLE / CLEVITE - DURA-BOND BEARING SETS (Cont.)							
CLEVITE	DURA-BOND	CLEVITE	DURA-BOND	CLEVITE	DURA-BOND	CLEVITE	DURA-BOND
SH1396S	TO-12	SH2144S	CHP-12	SH567S	F-23A	SH994S	IN-19
SH1401S	CHP-8R2	SH2147S	351HP	SH568S	CU-5A	INDIVIDUAL CAMSHAFT BEARINGS	
SH1403S	PDG-29S	SH2152S	PDP-17	SH56S	CO-8		
SH1405S	PD-28	SH2157S	CHP-25	SH590S	F-42	SH-1001	BL-1-1
SH1429S	MIG-2	SH2160S	CHP-10	SH614S	WA-7	SH-1002	BL-1-2
SH142S	WA-11	SH2181S	DE-4	SH615S	CH-9A	SH-1003	BL-1-3
SH1430S	TO-14	SH21S	F-1	SH616S	CH-12	SH-1062	TO-10-3
SH1431S	IZ-7	SH220S	IN-14	SH617S	GM-12	SH-1063	TO-1-4
SH1441S	F-50	SH23S	PD-1	SH628S	A-5	SH-1065	TO-11-3
SH1447S	F-52	SH277S	C-2	SH629S	A-4	SH-1067	F-41-1
SH1448S	B-13	SH287S	CH-4	SH643S	F-24	SH-1092	IN-17-1
SH1450S	MA-8	SH290S	CH-8	SH652S	F-43	SH-1093	IN-17-2
SH1455S	DI-2	SH291S	P-3	SH671S	N-9	SH-1094	AGB-29-1
SH1457S	IZ-3	SH292S	P-4	SH676S	MA-7	SH-1095	AGB-34-1
SH1462S	IZ-1	SH313S	PD-8	SH681S	IN-10A	SH-1096	AGB-34-2
SH1463S	IZ-5	SH322S	HE-5	SH690S	CA-8	SH-1111	F-30-1
SH1469S	MIG-3	SH330S	WA-4	SH693S	MA-5	SH-1112	PD-25-2
SH1481S	TO-15	SH343S	F-12	SH698S	DE-2	SH-1113	PD-25-3
SH1526S	FG-51	SH344S	F-11	SH699S	DE-2A	SH-1114	PD-25-4
SH1529S	CU-9	SH354S	IN-15	SH69S	J-1	SH-1115	PD-21-1
SH1762S	CAT-1	SH361S	B-8	SH700S	DE-7	SH-1116	PD-21-2
SH1764S	CAT-5	SH369S	F-16	SH701S	DE-5	SH-1117	PD-21-3
SH1765S	CAT-8	SH37S	PD-3	SH703S	F-32	SH-1131	MZ-1-1
SH1766S	F-57	SH383S	CH-3	SH704S	CA-6	SH-1132	MZ-1-2
SH1772S	RDCP-1	SH384S	A-1	SH705S	CA-7	SH-116	IN-5-1
SH1780S	CHG-22	SH385S	A-2	SH710S	F-26	SH-117	IN-5-2
SH1789S	F-48A	SH386S	BU-2	SH711S	F-28	SH-118	IN-5-3
SH1796S	GMP-8	SH398S	CH-5	SH716S	CH-13	SH-1190	AGB-14-1
SH1798S	CHG-15A	SH399S	CH-7	SH718S	CH-11	SH-1191	CA-9-1
SH1812S	B-14	SH400S	CH-6	SH719S	A-3	SH-1197	F-45-1
SH1814S	CH-10	SH426S	IN-11	SH720S	TO-3	SH-1198	F-45-2
SH1816S	GM-9	SH439S	WA-9	SH725S	TO-7	SH-1209	VWG-1-1
SH186S	CO-7	SH464S	F-19	SH730S	TO-8	SH-1210	VWG-1-2
SH190S	K-1	SH481S	DA-2	SH732S	F-25	SH-1211	K-1-1
SH191S	CO-3	SH493S	IN-3	SH733S	F-29	SH-1245	CAT-1-2
SH1977S	FG-53	SH500S	JD-1	SH735S	VW-1	SH-1251	F-46-1
SH1980S	N-10	SH501S	JD-2	SH767S	DA-1	SH-1252	F-46-2
SH198S	HE-1	SH502S	CA-3	SH772S	DA-3A	SH-1253	F-46-3
SH1990S	PD-31B	SH506S	B-6	SH777S	F-34	SH-1254	F-49-1
SH1995S	CH-23	SH507S	IN-18	SH781S	F-33	SH-1256	PDG-26-2
SH1996S	IN-21	SH510S	F-18	SH785S	JD-4	SH-1269	TOG-8-1
SH1997S	PDG-30	SH-527S	DE-1	SH786S	JD-3	SH-1270	TOG-8-2
SH1999S	GM-8	SH529S	N-6	SH791S	VO-2	SH-128	F-29-1
SH2002S	CHG-24	SH530S	C-3	SH796S	OP-3	SH-129	F-29-2
SH2012ST	DT-1T	SH531S	JD-5	SH84S	BL-1	SH-130	F-29-3A
SH2013ST	GMP-12LT	SH533S	F-22	SH874S	PD-18	SH-1305	CH-20-1
SH2014ST	GMP-2T	SH534S	F-7	SH875S	PD-16	SH-1321	FP-18-1
SH2015ST	SBF-1T	SH538S	IN-16	SH876S	PD-17	SH-1322	FP-18-2
SH209S	CH-2	SH543S	IN-20	SH905S	IZ-8	SH-1323	FP-18-3
SH2121S	CH-24	SH549S	N-7	SH906S	IZ-6	SH-1324	FP-18-4
SH2125S	CH-25	SH558S	IN-12	SH907S	IZ-2	SH-1325	FP-18-5
SH2140S	JDG-7	SH559S	F-9B	SH951S	NI-2	SH-1326	PDG-26-1
SH2141S	MA-11	SH561S	HE-7	SH952S	DA-5	SH-1328	WA-8-1
SH2142S	GMP-25	SH562S	HE-8	SH978S	TO-2	SH-1329	WA-8-2
SH2143S	MAG-11	SH563S	MAG-10	SH993S	MA-6	SH-133	VW-1-1

Reference interchange only. Check manufacture specifications prior to installation.

BEARING COMPETITIVE INTERCHANGES

MAHLE / CLEVITE - DURA-BOND INDIVIDUAL BEARINGS (Cont.)							
CLEVITE	DURA-BOND	CLEVITE	DURA-BOND	CLEVITE	DURA-BOND	CLEVITE	DURA-BOND
SH-1334	F-48-1	SH-1406	PD-28-2	SH-1997	PDG-30-1	SH-24	PD-1-2
SH-1335	F-48-2	SH-1407	PD-28-3	SH-1998	PDG-30-2	SH-249	F-7-2
SH-1336	F-48-4	SH-1408	PD-28-4	SH-1999	GM-8-1	SH-25	PD-1-3
SH-134	VW-1-2	SH-142	WA-11-1	SH-2002	CHG-24-1	SH-250	F-8-1
SH-1349	CHP-4-1	SH-1429	MIG-2-1	SH-2006	GM-8-2	SH-252	R-1-1
SH-1350	CHP-4-2	SH-1441	F-50-1	SH-2011	JD-6-1	SH-253	R-1-2
SH-1351	CHP-4-3	SH-1442	F-50-2	SH-2012	DT-1-1T	SH-254	R-1-3
SH-1352	CH-4-1S1	SH-1443	F-50-3	SH-2013	CH-12-3LT	SH-255	R-1-4
SH-1354	O-6-1	SH-1444	F-50-4	SH-2014	GMP-2-1T	SH-263	CH-3-1
SH-1355	O-6-2	SH-1446	F-51-2	SH-2015	351-HPB-1T	SH-264	CH-3-2
SH-1356	O-6-3	SH-1447	F-52-1	SH-2016	351-HPB-2T	SH-265	CH-3-3
SH-1357	O-6-4	SH-1448	B-13-1	SH-2017	351-HPB-3T	SH-277	C-2-1
SH-1358	O-6-5	SH-1450	MA-8-1	SH-2018	351-HPB-4T	SH-278	C-2-2
SH-1359	O-7-1	SH-1463	IZ-5-1	SH-2019	351-HPB-5T	SH-285	F-9-1
SH-1360	B-11-1	SH-1464	IZ-5-2	SH-2020L	PDA-4-1	SH-287	CH-4-3
SH-1361	B-9-2	SH-1487	CAT-4-2	SH-2020U	PDA-4-2	SH-288	CH-4-2
SH-1362	CH-18-1A	SH-1488	CAT-4-1	SH-209	CH-2-4	SH-289	CH-4-4
SH-1362-80	CH-18-1R8	SH-1526	AGB-51-1	SH-21	F-1-1	SH-290	CH-4-1
SH-1363	CH-18-2	SH-1529	CU-9-1	SH-2121	CH-24-1	SH-291	P-3-1
SH-1363-80	CH-18-2R8	SH-1762	CAT-1-1	SH-2122	CH-24-2	SH-292	P-3-2
SH-1364	CH-18-4	SH-1764	CAT-5-0	SH-2123	CH-24-3	SH-313	PD-8-1
SH-1364-80	CH-18-4R8	SH-1765	CAT-5-1	SH-2124	CH-25-2	SH-314	PD-8-2
SH-1365	CH-19-1	SH-1766	F-30-1S	SH-2125	CH-25-3	SH-315	PD-8-3
SH-1366	GM-7-1	SH-1789	F-48-4A	SH-2140	JDG-7-1	SH-318	CU-1-1
SH-1367	GM-7-2	SH-1798	CHG-15-1	SH-2141	MA-11-1	SH-322	HE-5-1
SH-1368	GM-7-3	SH-1798T	SH-1798T	SH-2142	MA-11-2	SH-323	HE-5-2
SH-1369	GM-7-4	SH-1812	B-14-1	SH-2143	MAG-11-1	SH-324	O-5-1
SH-1370	GM-7-5	SH-1813	B-14-2	SH-2144	CHP-12-1	SH-326	PD-9-2
SH-1371	C-4-1	SH-1814	CH-10-1	SH-2145	CHP-12-2	SH-327	PD-9-3
SH-1372	C-4-2	SH-1815	CH-10-2	SH-2146	CHP-12-3	SH-328	PD-9-4
SH-1373	C-4-3	SH-1816	CH-10-3	SH-2147	351HP-1	SH-329	PD-9-5
SH-1374	C-4-4	SH-186	CO-7-1	SH-2148	351HP-2	SH-33	CH-2-1
SH-1375	C-4-5	SH-187	CO-7-2	SH-2149	351HP-3	SH-330	WA-1-1
SH-1377	CU-8-1	SH-188	CO-7-3	SH-2150	351HP-4	SH-331	WA-3-1
SH-1378	CU-9-2	SH-189	CO-7-4	SH-2151	351HP-5	SH-332	WA-3-2
SH-1386	F-31-1	SH-191	K-1-2	SH-2152	PDP-17-1	SH-333	WA-3-3
SH-1387	F-31-2	SH-197	HE-1-1	SH-2153	PDP-12-2	SH-338	H-5-1
SH-1388	F-31-3	SH-1977	FG-53-1	SH-2154	PDP-12-3	SH-339	H-5-2
SH-1389	F-31-4	SH-1978	FG-53-2	SH-2155	PDP-12-4	SH-34	CH-2-2
SH-1390	F-47-1	SH-198	HE-1-2	SH-2156	PDP-12-5	SH-340	H-5-3
SH-1391	F-47-2	SH-1980	N-10-1	SH-2157	CHP-25-1	SH-341	H-5-4
SH-1392	F-47-3	SH-1981	CU-14-1	SH-2158	CHP-25-2	SH-342	H-5-5
SH-1393	F-47-4	SH-1990	PD-31-1	SH-2159	CHP-25-3	SH-343	F-12-1
SH-1394	CU-11-1	SH-1990A	PD-31-1B	SH-2160	CHP-10-1	SH-344	F-11-2
SH-1395	CU-11-2	SH-1991	PD-31-2	SH-2161	CHP-10-2	SH-35	CH-2-3
SH-1396	TO-12-1	SH-1991A	PD-31-2B	SH-2162	CHP-10-3	SH-351	IN-10-2
SH-1397	TO-12-2	SH-1992	PD-31-3	SH-2164	JD-7-1	SH-352	IN-10-3
SH-1398	TO-12-3	SH-1992A	PD-31-3B	SH-2181	DE-4-1	SH-354	IN-15-1
SH-1399	TO-12-4	SH-1993	PD-31-4	SH-2185	CHP-5-3	SH-355	IN-15-2
SH-1400	TO-12-5	SH-1993A	PD-31-4B	SH-22	F-1-2	SH-356	IN-15-3
SH-1402	CA-11-1	SH-1994	PD-31-5	SH-220	IN-8-2	SH-357	MA-3A-1
SH-1403	PDG-29-1	SH-1994A	PD-31-5B	SH-221	IN-2-3	SH-361	B-4-1
SH-1403-S	PDG-29-1SR1	SH-1995	CH-23-1	SH-222	IN-2-4	SH-363	B-4-3
SH-1404	CU-12-1	SH-1995A	CH-25-1	SH-224	IN-8-4	SH-364	B-4-4
SH-1405	PD-28-1	SH-1996	IN-21-1	SH-23	PD-1-1	SH-365	B-4-5

Reference interchange only. Check manufacture specifications prior to installation.

BEARING COMPETITIVE INTERCHANGES

MAHLE / CLEVITE - DURA-BOND INDIVIDUAL BEARINGS (Cont.)							
CLEVITE	DURA-BOND	CLEVITE	DURA-BOND	CLEVITE	DURA-BOND	CLEVITE	DURA-BOND
SH-369	F-16-1	SH-493	IN-3A-1	SH-618	CH-9-4	SH-727	TO-7-3
SH-37	PD-3-2	SH-500	JD-1-1	SH-628	A-3-1	SH-728	TO-7-4
SH-370	F-16-2	SH-501	JD-1-2	SH-629	A-3-2	SH-729	TO-7-5
SH-375	F-14-5	SH-502	CA-3-1	SH-643	F-24-2	SH-730	TO-8-1
SH-377	F-15-2	SH-503	CA-3-2	SH-644	F-24-3	SH-731	TO-8-2
SH-378	F-15-3	SH-504	CA-3-3	SH-645	F-24-4	SH-732	F-25-1
SH-379	F-15-4	SH-506	B-6-1	SH-646	F-24-5	SH-759	TO-5-1
SH-38	PD-3-3	SH-507	IN-18-1	SH-652	F-43-1	SH-760	TO-5-2
SH-380	F-15-5	SH-508	IN-18-2	SH-671	N-9-1	SH-762	TO-5-4
SH-383	CH-3-4	SH-509	IN-18-3	SH-672	N-8-2	SH-763	TO-5-5
SH-384	A-1-1	SH-510	F-18-1	SH-673	N-8-3	SH-767	DA-1-1
SH-385	A-2-1	SH-511	F-18-2	SH-674	N-8-4	SH-768	DA-1-2
SH-386	BU-1-1	SH-512	F-18-3	SH-675	N-8-5	SH-769	DA-1-3
SH-387	BU-1-2	SH-513	F-18-4	SH-676	MA-5-3	SH-770	DA-1-4
SH-388	BU-1-3	SH-514	F-18-5	SH-681	IN-10-1A	SH-771	DA-1-5
SH-398	CH-5-1	SH-518	CA-4-2	SH-682	IN-10-4A	SH-772	DA-3-1
SH-399	CH-5-2	SH-529	N-6-1	SH-686	DE-2-1	SH-774	DA-3-3A
SH-400	CH-5-3	SH-530	C-3-1	SH-687	DE-2-2	SH-777	F-34-1
SH-401	CH-5-4	SH-531	JD-5-1	SH-688	DE-2-3	SH-781	F-33-1
SH-403	PD-12-2	SH-532	JD-5-2	SH-689	CA-4-1	SH-786	JD-3-1
SH-404	PD-12-3	SH-533	F-22-1	SH-69	J-1-1	SH-796	VO-2-1
SH-405	PD-12-4	SH-538	IN-16-1	SH-693	MA-5-2	SH-797	VO-2-2
SH-406	PD-12-5	SH-539	IN-16-3	SH-694	FT-3-1	SH-798	VO-2-3
SH-412	F-17-2	SH-549	N-7-1	SH-695	FT-3-2	SH-813	OP-3-1
SH-413	F-17-3	SH-550	N-7-2	SH-696	FT-3-3	SH-814	OP-3-2
SH-414	F-17-4	SH-551	N-7-3	SH-703	F-32-1	SH-815	OP-5-3
SH-424	PD-13-3	SH-552	N-7-4	SH-704	CA-6-1	SH-816	OP-3-3
SH-425	PD-13-4	SH-559	F-9-2B	SH-705	CA-6-2	SH-874	PD-18-1
SH-426	IN-11-1	SH-56	K-1-3	SH-706	CA-6-3	SH-875	PD-16-1
SH-427	IN-11-2	SH-560	MA-5-1	SH-710	F-26-1	SH-876	PD-17-1
SH-428	IN-11-3	SH-561	HE-7-1	SH-711	F-28-1	SH-907	IZ-2-1
SH-429	IN-11-4	SH-563	MAG-10-1	SH-712	F-28-2	SH-908	IZ-2-2
SH-430	IN-11-5	SH-564	MAG-10-2	SH-713	F-28-3	SH-909	IZ-2-3
SH-455	IN-8-3	SH-567	F-23-1A	SH-716	CH-13-1	SH-914	MZ-1-3
SH-464	F-19-1	SH-568	CU-5-2A	SH-717	CH-13-2	SH-978	TO-2-1
SH-465	F-19-2	SH-57	K-1-4	SH-720	TO-3-1	SH-979	TO-2-2
SH-466	F-19-3	SH-580	FT-1-3	SH-721	TO-3-2	SH-980	TO-2-3
SH-467	F-19-4	SH-581	FT-1-2	SH-722	TO-3-3	SH-994A	IN-19-1
SH-470	N-5-2	SH-615	CH-12-1	SH-723	TO-3-4	SH-995A	IN-19-2
SH-471	N-5-3	SH-616	CH-12-2	SH-725	TO-7-1	SH-996A	IN-19-3
SH-472	N-5-4	SH-617	CH-12-3	SH-726	TO-7-2	SH-997A	IN-19-4

Reference interchange only. Check manufacture specifications prior to installation.

BEARING COMPETITIVE INTERCHANGES

ENGINETECH - DURA-BOND BEARING SETS							
ENGINETECH	DURA-BOND	ENGINETECH	DURA-BOND	ENGINETECH	DURA-BOND	ENGINETECH	DURA-BOND
CC1061	F-41	CC411	CH-12	CC443	F-32	CC456	F-34B
CC1407	TO-12	CC412	B-12B	CC444	F-31	CC470	PD-16
CC400	CH-8	CC413	C-4A	CC445G	F-23B	CC471	PD-18
CC401	CH-19	CC414	CH-4	CC446G	F-49B	CC472	PD-21
CC402	CH-16	CC415	CH-21	CC447	F-45	CC473	PD-27
CC403	CH-20	CC416	P-4	CC448	F-26	CC474	PD-25
CC404B	CH-18A	CC417	C-3	CC449	F-33	CC475	PD-28
CC405	CH-7	CC418	O-6	CC450	F-30	CC476	PD-17
CC406	CH-11	CC419	B-9	CC451	F-48	CC480	N-7
CC407	CH-17	CC420	GM-7	CC452	F-52	CC481	N-9
CC408	B-12	CC440	F-18	CC453	F-47B	CC482	IN-11
CC409	B-13	CC441	F-34	CC454	F-50A	CC483	IN-17
CC410	O-7	CC442	F-46	CC455	FG-51		

FEDERAL-MOGUL - DURA-BOND BEARING SETS							
F-M	DURA-BOND	F-M	DURA-BOND	F-M	DURA-BOND	F-M	DURA-BOND
1005M	F-1	1216M	C-3	1426M	CA-6	1489M	O-8
1010M	PD-1	1218M	IN-11	1427M	CA-7	1490M	JDG-7
1011M	PD-3	1220M	P-4	1428M	A-5	1491M	CA-8
1017M	A-2	1222M	F-22	1438M	CAT-2	1492M	CH-18
1088M	K-1	1223M	F-9B	1439M	F-32	1493M	F-45
1089M	F-5	1226M	HE-8	1441M	F-31	1494M	F-46
1090M	HE-1	1227M	CA-3	1442M	F-41	1496M	GM-7
1091M	J-1	1228M	IN-15	1443M	F-34	1497M	CA-9
1093M	CO-3	1229M	IN-3	1444M	CHG-14	1543M	BL-1
1094M	CH-2	1230M	IN-12	1445M	F-33	1557M	CH-11
1106M	IN-5	1234M	O-6	1447M	F-25	1561M	VO-2
1115M	C-2	1235M	CH-8	1449M	CU-13	1565M	TO-3
1119M	A-1	1235M1	CH-8W	1450M	F-23A	1566M	TO-2
1133M	F-7	1244M	N-7	1451M	PD-16	1569M	TO-8
1136M	WA-3	1246M	CU-5A	1453M	PD-17	1570M	DA-3A
1137M	WA-4	1251M	JD-1	1454M	PD-18	1591M	IN-18
1142M	HE-5	1253M	CA-5	1458M	CU-14	1592M	DA-1
1145M	CH-4	1255M	CH-9A	1459M	F-28	1672M	TO-11
1146M	P-3	1259M	JD-3	1460M	FG-34	1697M	VO-3
1149M	PD-8	1260M	JD-4	1461M	CH-16	1713M	VW-1
1151M	BU-2	1267M	F-24	1462M	B-12	1726M	VWG-1
1158M	CO-8	1269M	B-8	1463M	CH-17	1729M	TOG-8
1159M	F-12	1274M	MA-6	1463M1	CH-17X	1731M	FG-29
1160M	F-9A	1275M	WA-7	1466M	O-7	1735M	TO-10
1164M	O-5	1325M	DA-2	1467M	IN-17	1737M	OP-5
1170M	CH-3	1394M	HO-3	1470M	IN-19	1738M	DA-5
1176M	H-5	1401M	N-9	1473M	PD-21	1746M	IZ-3
1177M	CH-5	1402M	IN-16	1474M	CO-9	1750M	CH-4A
1179M	F-16	1403M	F-26	1475M	JD-5	1752M	CU-11A
1198M	GM-5	1404M	CH-12	1477M	F-43	1753M	CU-11
1202M	CH-6	1406M	MA-5	1478M	F-44	1755M	B-13
1203M	CH-7	1409M	MA-7	1479M	IN-10A	1756M	CH-20
1204M	F-18	1412M	F-29	1481M	ON-1	1757M	C-4
1205M	B-6	1414M	F-30	1484M	PD-25	1758M	TO-14
1209M	IN-14	1417M	MAG-10	1485M	CH-19	1760M	NI-2
1211M	DE-2	1421M	B-11	1486M	DE-4	1762M	DB-1
1213M	DE-5	1422M	B-9	1487M	PDG-26	1771M	TO-12
1214M	A-6	1424M	A-4	1488M	CU-9	1774M	TO-13

Reference interchange only. Check manufacture specifications prior to installation.

BEARING COMPETITIVE INTERCHANGES

FEDERAL-MOGUL - DURA-BOND BEARING SETS (Cont.)							
F-M	DURA-BOND	F-M	DURA-BOND	F-M	DURA-BOND	F-M	DURA-BOND
1776M	NI-3	1921M	N-10	FPR57160S	JDG-7	1741-DR	R-1-1
1777M	F-48	1922M	CH-24	INDIVIDUAL CAMSHAFT BEARINGS		1742-DR	R-1-2
1781M	F-49	1923M	CH-25			1743-DR	R-1-3
1782M	B-12B	1924M	CHG-23	1058-DRL	MZA-2-3	1744-DR	R-1-4
1784M	F-55	1925M	TOG-9	1059-DRL	MZA-2-2	1832-DR	F-7-2
1790M	PD-27	1926M	TOG-10	1059-DRU	MZA-2-1	1833-DR	F-22-1
1792MSEMI	PDG-29S	1927M	TOG-11A	1071-DR	NI-2-1	1836-DR	F-8-1
1793M	F-47	1928M	TOG-11	1072-DR	NI-2-2	1838-DR	F-12-1
1794M	TO-7	1929M	MIA-4	1073-DR	NI-2-3	1839-DR	F-11-2
1803M	MI-3	1930M	MIA-5	1074-DR	NI-2-4	1841-DRI	PD-16-1
1804M	IZ-8	1931M	MZA-4	1086-DRI	DE-6-1S	1846-DR	NIA-2-1
1805M	MIG-2	1932M	SA-1	1088-DR	DE-6-2	1847-DR	NIA-3-1
1807M	FG-51	2100M	CHP-8	1091-DRL	HA-1-3	1848-DR	NIA-3-2
1808M	IZ-4	2101M	CHP-12	1091-DRU	HA-1-2	1852-DR	MA-3A-1
1809M	PD-28	2102M	FP-18	1092-DRU	HA-1-4	1866-DR	WA-1-1
1810M	MIG-3	2103M	FP-26	1093-DRU	HA-1-4A	1921-DR	PD-28-1
1828M	CHG-22	2104M	FP-30	1101-DR	IN-5-1	1922-DR	PD-28-2
1838M	F-47B	2105M	GMP-1	1102-DR	IN-5-2	1922-DRB	PD-28-2B
1839M	NIA-4	2106M	GMP-8	1103-DR	IN-5-3	1923-DR	PD-28-3
1840M	PDA-1	2107M	GMP-12	1121-DR	BMA-1-1	1923-DRB	PD-28-3B
1841M	VVA-2	2108M	351HP	1122-DR	BMA-1-2	1924-DR	PD-28-4
1842M	F-34B	2110M	PDP-16	1123-DR	BMA-1-3	1951-DR	CH-3-1
1843M	F-48A	2111M	PDP-17	1124-DR	BMA-1-4	1952-DR	CH-3-2
1844M	F-50	2112M	PDP-25T	1206-DR	K-1-1	1953-DR	CH-3-3
1845M	351RHP	3204DR	CHG-15A	1207-DR	K-1-2	1961-DR	CU-1-1
1847M	FA-2	FP1017M	A-2	1208-DR	K-1-3	1962-DRI	CU-5-2A
1848M	FA-1	FP1090M	HE-1	1209-DR	K-1-4	2003-DR	F-9-1
1855M	CH-21	FP1093M	CO-3	1221-DR	F-48-1	2004-DRI	F-9-2B
1855M1	CH-21X	FP1106M	IN-5	1221-DRA	F-48-1	2021-DR	CH-4-1
1856M	MZA-1	FP1119M	A-1	1222-DR	F-48-2	2021-DR1	CH-4-1W
1857M	NIA-1	FP1137M	WA-4	1222-DRA	F-48-2	2022-DR	CH-4-2
1858M	MIA-1	FP1142M	HE-5	1223-DRA	F-48-4A	2023-DR	CH-4-3
1859M	TOA-1	FP1151M	BU-2	1246-DR	NIA-4-1	2024-DR	CH-4-4
1860M	MIA-3	FP1158M	CO-8	1247-DR	NIA-4-2	2046-DR	PD-8-1
1861M	HA-1	FP1214M	A-6	1401-DR	FA-1-1	2047-DR	PD-8-2
1862M	HA-2	FP1226M	HE-8	1402-DR	FA-1-2	2048-DR	PD-8-3
1863M	MZA-2	FP1227M	CA-3	1403-DR	FA-1-3	2054-DR	F-9-3
1865M	NIA-6	FP1228M	IN-15	1404-DR	FA-1-4	2101-DR	B-4-1
1869M	NIA-3R	FP1251M	JD-1	1404-DRI	FA-1-5	2103-DR	B-4-3
1871M	VOA-1	FP1274M	MA-6	1419-DR	CH-2-4	2103-DRI	B-4-4
1874M	GM-12	FP1275M	WA-7	1421-DR	HE-5-1	2104-DR	B-4-5
1881M	FG-53	FP1402M	IN-16	1422-DR	HE-5-2	2106-DR	IN-15-1
1886M	F-52	FP1406M	MA-5	1496-DRL	HA-1-5	2107-DR	IN-15-2
1888M	CH-10	FP1409M	MA-7	1497-DRU	HA-1-1	2108-DR	IN-15-3
1889M	B-14	FP1424M	A-4	1557-DR	P-3-1	2132-DR	PD-9-2
1891M	WA-8	FP1428M	A-5	1558-DR	O-5-1	2133-DR	PD-9-4
1894M	PD-28B	FP1474M	CO-9	1559-DR	P-3-2	2133-DRI	PD-9-3
1895M	PDG-30	FP1475M	JD-5	1561-DR	C-2-1	2134-DR	PD-9-5
1896M	PD-30	FP1479M	IN-10A	1563-DR	C-2-2	2136-DR	PD-30-1
1898M	CH-23	FP1481M	ON-1	1577-DR	IN-8-2	2137-DR	PD-30-2
1900M	FA-3R	FP1591M	IN-18	1578-DR	IN-8-3	2138-DR	PD-30-3
1901M	FA-11	FP1753M	CU-11	1579-DR	IN-8-4	2139-DR	PD-30-4
1907M	FA-9	FP448139	IN-10A	1616-DR	BU-1-1	2141-DR	PD-30-5
1918M	PDA-7	FP92750	WA-12	1617-DR	BU-1-2	2142-DR	PD-30-6
1920M	PD-31B	FP92752	WA-8	1618-DR	BU-1-3	2154-DR	CH-3-4

Reference interchange only. Check manufacture specifications prior to installation.

BEARING COMPETITIVE INTERCHANGES

FEDERAL-MOGUL - DURA-BOND INDIVIDUAL BEARINGS (Cont.)							
F-M	DURA-BOND	F-M	DURA-BOND	F-M	DURA-BOND	F-M	DURA-BOND
2197-DR	IN-10-2	2528-DR	N-5-3	3082-DR	CA-4-2	3517-DR	CAT-3-2
2198-DR	IN-10-3	2529-DR	N-5-4	3083-DR	CA-5-3	3547-DR	F-34-1
2207-DR	JD-5-2	2531-DR	CAT-2-1	3086-DR	CA-9-1	3547-DRA	F-34-1B
2231-DR	H-5-1	2532-DR	CAT-2-2	3088-DR	HO-3-1	3548-DR	AGB-34-1
2232-DR	H-5-2	2533-DR	CAT-2-5	3089-DR	HO-3-2	3549-DR	AGB-34-2
2233-DR	H-5-3	2533-DRI	CAT-2-3	3090-DR	HO-3-3	3571-DR	AGB-14-1
2233-DRI	H-5-4	2534-DR	CAT-2-6	3091-DR	HO-3-4	3586-DR	F-19-1
2234-DR	H-5-5	2534-DRI	CAT-2-4	3106-DR	F-43-1	3591-DR	CU-13-1
2286-DR	CH-5-1	2556-DR	CH-20-1	3126-DR	JD-3-1	3592-DR	CU-13-2
2287-DR	CH-5-2	2587-DR	F-19-2	3151-DRA	F-23-1A	3596-DR	IN-10-1A
2288-DR	CH-5-3	2588-DR	F-19-3	3152-DR	F-49-1	3597-DR	IN-10-4A
2289-DR	CH-5-4	2588-DRI	F-19-4	3153-DR	F-49-2	3671-DR	JDG-7-1
2301-DRA	F-33-1	2596-DR	JD-1-1	3181-DR	ON-1-1	3681-DR	CAT-4-1
2302-DR	F-15-2	2597-DR	JD-1-2	3191-DRI	CH-12-1	3682-DR	CAT-4-2
2303-DR	F-15-3	2601-DR	F-18-1	3192-DRI	CH-12-2	3731-DR	IN-17-1
2303-DRI	F-15-4	2601-DRI	F-26-1	3193-DRI	CH-12-3	3732-DR	IN-17-2
2304-DR	F-15-5	2602-DR	F-18-2	3194-DR	CH-9-4	3766-DRI	CH-18-1A
2309-DR	F-14-5	2603-DR	F-18-3	3204-DR	CHG-15-1	3767-DR	CH-18-2
2316-DR	F-16-1	2603-DRI	F-18-4	3216-DR	F-24-2	3768-DR	CH-18-4
2317-DR	F-16-2	2604-DR	F-18-5	3217-DR	F-24-3	3796-DR	CH-19-1
2321-DRI	PD-17-1	2631-DR	MA-5-1	3218-DR	F-24-4	3801-DR	PDG-26-1
2322-DR	PD-12-2	2632-DR	MA-5-2	3219-DR	F-24-5	3802-DR	PDG-26-2
2322-DRA	PD-21-2	2636-DR	CA-3-1	3311-DRI	N-9-1	3803-DR	PDG-29-1
2323-DR	PD-12-3	2637-DR	CA-3-2	3312-DR	N-8-2	3806-DR	FA-2-1
2323-DRI	PD-12-4	2638-DR	CA-3-3	3313-DR	N-8-3	3808-DR	FA-2-3
2324-DR	PD-12-5	2684-DR	N-10-1	3313-DRI	N-8-4	3809-DR	FA-2-4
2376-DRA	PD-21-1	2686-DR	N-7-1	3314-DR	N-8-5	3809-DRI	FA-2-5
2376-DRI	PD-18-1	2687-DR	N-7-2	3321-DRI	B-11-1	3826-DR	CU-9-1
2378-DR	PD-13-3	2688-DR	N-7-3	3322-DR	B-9-2	3827-DR	CU-9-2
2378-DRA	PD-21-3	2689-DR	N-7-4	3322-DRI	B-14-2	3828-DR	CU-8-1
2379-DR	PD-13-4	2727-DR	DB-1-2	3323-DR	B-13-1	3831-DR	F-45-1
2381-DRA	F-32-1	2728-DR	DB-1-3	3323-DRI	B-14-1	3832-DR	F-45-2
2381-DRB	F-46-1	2729-DRI	DB-1-4	3324-DR	B-11-1B	3834-DR	AGB-51-1
2382-DR	F-17-2	2786-DRA	F-28-1	3336-DR	IN-16-1	3861-DR	GM-7-1
2382-DRA	F-46-2	2787-DRA	F-28-2	3338-DR	IN-16-3	3862-DR	GM-7-2
2383-DR	F-17-3	2788-DRA	F-28-3	3357-DRC	F-47-2B	3863-DR	GM-7-3
2383-DRA	F-46-3	2849-DR	FT-1-2	3358-DRC	F-47-3B	3864-DR	GM-7-4
2384-DR	F-17-4	2926-DR	CO-9-1	3359-DRC	F-47-4	3866-DR	GM-7-5
2401-DR	GM-5-1	2927-DR	CO-9-2	3361-DRI	F-30-1	3871-DR	C-4-1
2402-DR	GM-5-2	2928-DR	CO-9-3	3366-DR	F-29-1	3872-DR	C-4-2
2403-DR	GM-5-3	2941-DR	C-3-1	3367-DR	F-29-2	3873-DR	C-4-3
2404-DR	GM-5-4	3031-DR	HE-7-1	3368-DRA	F-29-3A	3874-DR	C-4-4
2411-DR	IN-11-1	3046-DR	O-6-1	3369-DR	AGB-29-1	3876-DR	C-4-5
2412-DR	IN-11-2	3046-DRI	O-7-1	3426-DR	CH-4-1S	3961-DRL	TOA-2-1
2413-DR	IN-11-3	3047-DR	O-6-2	3451-DR	PD-25-2	3961-DRU	TOA-2-2
2413-DRI	IN-11-4	3048-DR	O-6-3	3452-DR	PD-25-3	3962-DRL	TOA-1-2
2414-DR	IN-11-5	3048-DRI	O-6-4	3453-DR	PD-25-4	3962-DRU	TOA-1-1
2421-DR	IN-3A-1	3049-DR	O-6-5	3456-DR	CH-13-1	3981-DR	TO-12-1
2431-DRI	CA-6-1	3056-DRI	F-31-1	3457-DR	CH-13-2	3982-DR	TO-12-2
2432-DRI	CA-6-2	3057-DRA	F-47-2	3466-DR	A-3-1	3983-DR	TO-12-3
2433-DR	CA-6-3	3057-DRI	F-31-2	3467-DR	A-3-2	3984-DR	TO-12-4
2502-DR	B-6-1	3058-DRA	F-47-3	3489-DR	MIA-3-1	3986-DR	TO-12-5
2521-DR	A-6-1	3058-DRI	F-31-3	3506-DR	CU-11-1	3996-DRB	F-52-4
2526-DR	N-6-1	3059-DRI	F-31-4	3507-DR	CU-11-2	3996-DRI	F-52-1
2527-DR	N-5-2	3081-DR	CA-4-1	3516-DR	CAT-3-1	3997-DRB	F-51-2

Reference interchange only. Check manufacture specifications prior to installation.

BEARING COMPETITIVE INTERCHANGES

FEDERAL-MOGUL - DURA-BOND INDIVIDUAL BEARINGS (Cont.)							
F-M	DURA-BOND	F-M	DURA-BOND	F-M	DURA-BOND	F-M	DURA-BOND
4176-DR	MZA-1-1	65328-DR	VO-2-3	68096-DR	VWG-1-1	9023-DR	F-1-2
4177-DR	MZA-1-2	65896-DRA	OP-3-1	68097-DR	VWG-1-2	9076-DR	PD-1-1
4178-DR	MZA-1-3	65897-DRA	OP-3-2	68276-DR	TO-7-1	9207-DR	PD-1-2
4206-DR	CU-12-1	65898-DRA	OP-3-3	68277-DR	TO-7-2	9208-DR	PD-1-3
4207-DR	CU-14-1	65899-DR	OP-5-3	68279-DR	TO-7-4	9216-DR	J-1-1
4226-DR	NIA-1-1	66621-DRL	VOA-1-1	68279-DRI	TO-7-5	9386-DR	HE-1-1
4227-DR	NIA-1-2	66621-DRU	VHA-1-2	68311-DR	IZ-6-1	9387-DR	HE-1-2
4228-DR	NIA-1-3	66781-DR	NI-3-2	68312-DR	IZ-6-2	9391-DR	A-2-1
4231-DRL	PDA-1-1	66782-DR	NI-3-1	68313-DR	MIG-2-2	9531-DR	F-3-1
4231-DRU	PDA-1-2	67016-DR	DA-3-1	68314-DR	MIG-2-1	9532-DR	F-3-2
4261-DR	MI-1-1	67017-DR	DA-3-2	7100-DR	351HP-1	9533-DR	F-3-3
4262-DR	MI-1-2	67018-DR	DA-3-3A	7101-DR	351HP-2	9561-DR	PD-3-2
4263-DR	MI-1-3	67021-DR	DA-2-1	7102-DR	351HP-3	9563-DR	PD-3-3
4264-DR	MI-1-4	67022-DR	DA-2-2	7103-DR	351HP-4	9626-DR	WA-3-1
4291-DR	F-50-1	67023-DR	DA-2-3	7104-DR	351HP-5	9627-DR	WA-3-2
4292-DR	F-50-2	67031-DR	TO-5-1	7105-DR	CHP-4-1	9628-DR	WA-3-3
4293-DR	F-50-3	67032-DR	TO-5-2	7106-DR	CHP-4-2	9696-DR	CH-2-1
4294-DR	F-50-4	67034-DR	TO-5-4	7107-DR	CHP-4-3	9697-DR	CH-2-2
4366-DRU	VWA-1-1	67034-DRI	TO-5-5	7108-DR	CHP-12-1	9698-DR	CH-2-3
4367-DRL	VWA-1-5	67036-DR	TO-1-1	7109-DR	CHP-12-2	9746-DR	A-1-1
4367-DRU	VWA-1-2	67037-DR	TO-1-2	7110-DR	CHP-12-3	9906-DR	CO-7-1
4368-DRL	VWA-1-3	67038-DRI	TO-10-3	7111-DR	FP-26-1	9907-DR	CO-7-2
4368-DRU	VWA-1-4	67039-DR	TO-1-4	7112-DR	FP-18-2	9908-DR	CO-7-3
4486-DR	FG-53-1	67041-DR	TO-2-1	7113-DR	FP-18-3	9909-DR	CO-7-4
4487-DR	FG-53-2	67042-DR	TO-2-2	7114-DR	FP-18-4	FP100670	CU-1-1
4509-DR	CH-23-1	67043-DR	TO-2-3	7115-DR	FP-18-5	FP3031037	CU-11-2
4511-DR	CH-10-1	67271-DR	TO-3-1	7116-DR	FP-30-1	FP3278345	CU-11-1
4512-DR	CH-10-2	67272-DR	TO-3-2	7117-DR	GMP-1-1	FP4026423	CU-15-1
4513-DR	CH-10-3	67273-DR	TO-3-3	7118-DR	FP-18-1	FP5194609	DE-1-1
4516-DR	CH-25-1	67274-DR	TO-3-4	7120-DR	PDP-16-1	FP5197922	DE-2-2
4517-DR	CH-25-2	67278-DR	TO-7-3	7121-DR	PDP-9-2	FP59GB217	MA-11-1
4518-DR	CH-25-3	67283-DR	TOG-8-1	7122-DR	PDP-9-3	FP59GB218	MA-11-2
4962-DR	PD-31-1B	67284-DR	TOG-8-2	7123-DR	PDP-9-4	FP61GB33	MAG-11-1
4963-DR	PD-31-2B	67293-DR	TO-11-3	7124-DR	PDP-9-5	FP6206211420	KO-1-1
4964-DR	PD-31-3B	67321-DR	DA-1-1	7125-DR	PDP-25-2	FP6206211430	KO-1-2
4966-DR	PD-31-4B	67322-DR	DA-1-2	7126-DR	PDP-25-3	FP7M4046	CAT-2-2
4967-DR	PD-31-5B	67323-DR	DA-1-3	7127-DR	PDP-25-4	FP92750-1	WA-8-2
4991-DR	CH-24-1	67324-DR	DA-1-4	7128-DR	PDP-17-1	FP92750-2	WA-8-1
4992-DR	CH-24-2	67324-DRI	DA-1-5	7129-DR	PDP-12-2	FP9M5238	CAT-2-6
4993-DR	CH-24-3	67326-DR	IZ-3-1	7130-DR	PDP-12-3	FP9M5239	CAT-2-5
60151-DR	IN-18-1	67327-DR	IZ-3-2	7131-DR	PDP-12-4	FP9N5246	CAT-1-2
60152-DR	IN-18-2	67328-DR	IZ-3-3	7132-DR	PDP-12-5	FP9Y2991	CAT-2-3
60153-DR	IN-18-3	67381-DRL	MIA-1-4	8778-DR	IN-2-3	FP9Y2992	CAT-2-4
65326-DR	VO-2-1	67381-DRU	MIA-1-3	8779-DR	IN-2-4	FPR46903	JD-3-1
65327-DR	VO-2-2	67382-DRU	MIA-1-1	9021-DR	F-1-1		

Reference interchange only. Check manufacture specifications prior to installation.

BEARING COMPETITIVE INTERCHANGES

KING BEARING - DURA-BOND BEARING SETS							
KING	DURA-BOND	KING	DURA-BOND	KING	DURA-BOND	KING	DURA-BOND
CBS324	O-5	CS412BB	TO-3	CS504BB	TO-7	CS534HPT	CHP-4T
CS101BB	J-1	CS414BB	CH-17	CS507BB	CH-8	CS535BB	C-4
CS1101BB	CHG-15A	CS415BB	B-12	CS507HP	CHP-8	CS536BB	GM-7
CS111BB	FG-29	CS416BB	PD-21	CS507HPT	CHP-8T	CS537BB	C-3
CS2101BB	PDG-30	CS417BB	F-34	CS508BB	B-9	CS538BB	P-3
CS2102BB	CHG-24	CS417BBX	F-34B	CS509BB	O-6	CS539BB	F-9A
CS228BB	PDG-26	CS418BB	F-32	CS510BB	O-7	CS540BB	F-16
CS230BB	VWG-1	CS419BB	F-23A	CS511BB	P-4	CS542BB	CH-5
CS231BB	FG-51	CS420BB	B-12B	CS512BB	PD-16	CS5501BB	CH-4A
CS232BB	FG-53	CS421BB	B-13	CS512HP	PDP-16	CS5502BB	B-11
CS304BB	DA-2	CS422BB	N-7	CS514BB	F-18	CS5503BB	CH-10
CS305BB	DA-3A	CS423BB	F-46	CS514HP	FP-18	CS5503HP	CHP-10
CS317BB	VO-2	CS424BB	F-47B	CS514HPT	FP-18T	CS5503HPT	CHP-10T
CS325BB	CH-16	CS425BB	F-48	CS515BB	F-33	CS5504HPT	DT-1T
CS326BB	CH-20	CS426BB	F-45	CS516BB	F-26	CS5505HPT	GMP-2T
CS327BB	MIG-2	CS427BB	F-49	CS516HP	FP-26	CS5506HPT	GMP-12LT
CS328BB	FG-34	CS428BB	CH-18A	CS517BB	F-30	CS5507BB	PDA-4
CS329BB	CHG-14	CS429BB	CH-18	CS517HP	FP-30	CS5509BB	C-2
CS3301BB	TOA-1	CS430BB	PD-27	CS517HPT	FP-30T	CS5510BB	CH-23
CS3302BB	CO-3	CS431BB	PD-28	CS524BB	CH-12	CS5510HP	CHP-23
CS3303BB	CH-6	CS432BB	F-52	CS524GMP	GMP-12	CS5510HPT	CHP-23T
CS3304BB	CA-3	CS433BB	K-1	CS524HP	CHP-12	CS5512BB	PD-31B
CS3305BB	MIG-3	CS434BB	CH-3	CS524HPT	CHP-12T	CS604BB	FA-3
CS330BB	F-41	CS435BB	CH-21	CS525BB	C-4A	CS605BB	FA-4
CS331BB	F-29	CS4401BB	B-14	CS526BB	N-9	CS606BB	FA-5
CS332BB	F-28	CS4402BB	F-49B	CS527BB	PD-25	CS6601BB	PD-30
CS333BB	PD-1	CS4403BB	F-50A	CS528BB	CH-19	CS6602BB	TOG-11
CS334BB	CO-8	CS4404BB	CH-9A	CS529BB	DA-1	CSGMP1	GMP-1
CS351HP	351HP	CS4405BB	F-1	CS530BB	IN-11	CSGMP12T	GMP-12T
CS351HPT	351HPT	CS4406BB	F-48A	CS531BB	CH-13	CSGMP1T	GMP-1T
CS351RHP	351RHP	CS4407BB	GM-5	CS532BB	IN-17	CSGMP8	GMP-8
CS401BB	PD-18	CS4408BB	CH-2	CS533BB	PD-17	CSGMP8T	GMP-8T
CS402BB	CH-7	CS4409BB	F-50	CS533HP	PDP-17		
CS405BB	CH-11	CS4410BB	F-23B	CS534BB	CH-4		
CS410BB	F-31	CS4411BB	CHG-23	CS534HP	CHP-4		

Reference interchange only. Check manufacture specifications prior to installation.

Dura-Bond[®]

Cam Bearing Tool

Here's the fast, simple, economical cam tool that eliminates hundreds of separate, costly driving plugs with four expanding mandrels. The Dura-Bond Cam Bearing Tool adjusts instantly to undersize cam bearings; lets you put them in and take them out of any engine. Be smart, Do it all—fast—with one tool from Dura-Bond.



CT-1 KIT

Part No.	Description	Part No.	Description
1-B	5" Driver	8-NS	2.250 Mandrel Sleeve
3-B	36" Driver	5-M	1.370 Mandrel
1-C	Guide Cone	6-M	1.682 Mandrel
3-E	17/32 Expander	7-M	1.875 Mandrel
4-E	15/8 Expander	8-M	2.250 Mandrel
1-S	Replacement Thread Stud for Expanders	5-W	1.370 Metal Washer
		6-W	1.682 Metal Washer
5-NS	1.370 Mandrel Sleeve	7-W	1.875 Metal Washer
6-NS	1.682 Mandrel Sleeve	8-W	2.2500 Metal Washer
7-NS	1.875 Mandrel Sleeve		

1 Replacement Bar Cap only for 24" and 36" Drivers

Optional (not included with kit):

2-B 24" Driver

THE REVOLUTIONARY NEW WAY TO REBUILD ALUMINUM HEADS with the

Dura-Bond® Boring System

O.H.C. Cutter System & Bearings for Aluminum Cylinder Heads

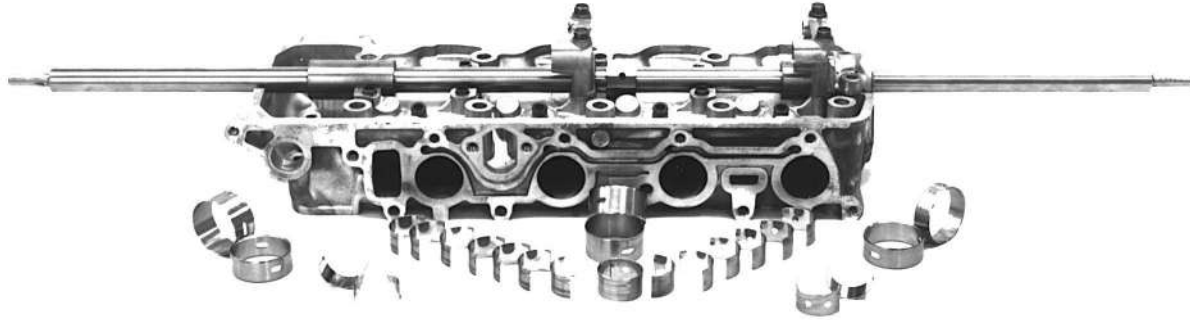

Features: Tapered bushings provide self alignment • No lengthy set up time • Bar is driven by a 1/2" electric or air drill motor • "No chatter." Cutters cut and ream to a factory finish in one operation.

Our **Quick Bore System** enables you to bore a complete cylinder head and install new repair bearings in approximately 25 minutes rather than 45 minutes or longer required by other systems.

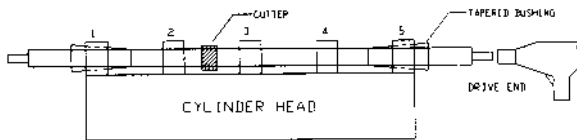

FIRST BORING PASS

RECOMMENDED BUSHING PLACEMENT IN THIS CONFIGURATION TO BORE #2, #3, AND #4.

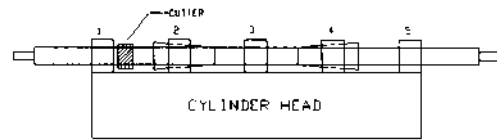

SECOND BORING PASS

RECOMMENDED BUSHING PLACEMENT IN THIS CONFIGURATION TO BORE OUTER HOUSINGS. UTILIZE RING BUSHINGS TO SUPPORT DRIVE BAR BUSHINGS.

- Cylinder heads that are warped extensively should be straightened before line boring.
- Extra long Drive Bar allows cutting of Multi-Housings.
- Electric drill with 1/2" chuck is used to drive the bar (500 - 600 RPM).
- Tapered bushings (.005 Taper) provide self alignment and eliminate hours of set up time and expensive fixtures. Use ring bushings around drive bar bushings to mount in bored housings.
- Cutters are designed to cut and ream in one operation. New three angle cutter design requires only light pressure to feed cutter through bore and because there is no chatter, cutter leaves a factory finish.
- Our system enables a complete cylinder head to be bored and five new bearings installed in under 20 minutes rather than 45 minutes or longer required by other systems.*
- Cutter locks on Drive Bar with two set screws.
- Push cutter through one time. **DO NOT REAM TWICE. DO NOT PULL CUTTER BACK THROUGH FINISHED BORED HOUSING.**
- Use a constant flow of penetrating oil when cutting. This is a must to wash away cutting chips and achieve a finish necessary to install the bearing set.
- If cutter binds or stops in bore loosen the cap, do not reverse cutter rotation, this will cause breakage of carbide. Lightly work out by hand or tap straight back on bar with mallet.

Refer to our data sheet for bearing, application, cutter, and bushing sizes.

*As tested and time studied at Dura-Bond Bearing Company.

ALUMINUM OVERHEAD CAM (OHC) ACCESSORIES

DURA-BOND QUICK BORE: BARS, BUSHINGS, AND CUTTERS

SET NO.	ENGINE MFG.	CONTENTS	POSITION	TOOLS		
				CUTTER	BUSHING / QTY	BAR
BMA-1* (Full Round)	BMW	BMA-1-1 BMA-1-2 BMA-1-3 BMA-1-4	1 2 3 4	DBC18918 DBC18524 DBC18131 DBC14587	DBB18119 / 1 DBB18524 / 1 DBB18131 / 1 DBB13788 / 1	DB 78 (7/8")
BMA-2* (Full Round)	BMW	BMA-1-1 BMA-1-2 BMA-1-3 BMA-1-10	1 2 3 4	DBC18918 DBC18524 DBC18131 DBC15772	DBB18119 / 1 DBB18524 / 1 DBB18131 / 1 DBB14969 / 1	DB 78 (7/8")
BMA-3* (Full Round)	BMW	BMA-1-1 BMA-1-5 BMA-1-2 BMA-1-6 BMA-1-3 BMA-1-7 BMA-1-10	1 2 3 4 5 6 7	DBC18918 DBC18524 DBC18131 DBC15772	DBB18119 / 1 DBB18524 / 1 DBB18131 / 1 DBB14969 / 1	DB 78 (7/8")
BMA-4* (Full Round)	BMW	BMA-1-8 BMA-1-9 BMA-4-3	1 2 3	DBC17741 DBC17340 DBC14587	DBB16937 / 1 DBB17340 / 1 DBB13787 / 1 DBB14587 / 1	DB 78 (7/8")
F-41* (Half Shell)	FORD MAZDA	F-41-1 F-41-2	1 1,2	N/A	N/A	N/A
FA-1* (Full Round)	FORD	FA-1-1 FA-1-2 FA-1-3 FA-1-4 FA-1-5	1 2 3 4 5	DBC19035 DBC18985 DBC18935 DBC18885 DBC18835	DBB18870 / 1 DBB18020 / 1 DBB22055 / 1	DB 78 (7/8")
FA-2* (Full Round)	FORD	FA-2-1 FA-2-2 FA-2-3 FA-2-4 FA-2-5	1 2 3 4 5	DBC18435 DBC18535 DBC18635 DBC18735 DBC18835	DBB22055 / 1 DBB1792 / 1 DBB1883 / 1 DBB18025 / 1	DB 78 (7/8")
FA-3* (Half Shell) .010 und .020 und	FORD	FA-3-1 (L) FA-3-2 (U)	1,2,3,4,5,6 1,2,3,4,5,6	DBC11474	DBB1063 / 2	DB 58 (5/8")
FA-4* (Half Shell)	FORD	FA-3-2 (L) FA-4-1 (L) FA-4-2 (L) FA-4-3 (U) FA-4-4 (U)	1,6,7,12 2,3,4,5 8,9,10,11 1,6,7,12 2,3,4,5,8,9,10,11	DBC11474	DBB1063 / 2	DB 58 (5/8")
FA-5* (Half Shell)	FORD	FA-5-1 (L) FA-4-1 (L) FA-4-2 (L) FA-4-3 (U) FA-4-4 (U)	1,6,7,12 2,3,4,5 8,9,10,11 1,6,7,12 2,3,4,5,8,9,10,11	DBC11474	DBB1063 / 2	DB 58 (5/8")
FA-6* (Half Shell) .010 und .020 und	FORD	FA-6-2 (U) FA-6-4 (U) FA-6-1 (L) FA-6-3 (L)	1 2,3,4 1 2,3,4	DBC11875	DBB11003 / 2	DB 58 (5/8")
FA-13L* (Half Shell) .010 und .020 und	FORD	FA-13-1(L) FA-13-2(U) FA-13-3(L) FA-13-4(U)	1 1 2,3,4,5 2,3,4,5	DBC12137	DBB1128 / 2	DB 58 (5/8")

*Denotes (OHC) Repair Bearing, Check "Aluminum Overhead Cam Accessories" Section For Tool Information

**Denotes Auxiliary / Balance Shaft Bearing

"und" Denotes Undersized ID

ALUMINUM OVERHEAD CAM (OHC) ACCESSORIES

DURA-BOND QUICK BORE: BARS, BUSHINGS, AND CUTTERS

SET NO.	ENGINE MFG.	CONTENTS	POSITION	TOOLS		
				CUTTER	BUSHING / QTY	BAR
FA-13R* (Half Shell) .010 und .020 und	FORD	FA-13-2(U) FA-13-5(L) FA-13-3(L) FA-13-4(U)	1 1 2,3,4,5 2,3,4,5	DBC12137	DBB1128 / 2	DB 58 (5/8")
FA-14L* (Half Shell)	FORD	FA-3-2(U) FA-3-1S(U) FA-3-1(L)	1,3,4,5,7 2,6 1,2,3,4,5,6,7	DBC11474	DBB1063 / 2	DB 58 (5/8")
FA-14R* (Half Shell)	FORD	FA-3-2(U) FA-3-1(L)	1,2,3,4,5,6,7 1,2,3,4,5,6,7	DBC11474	DBB1063 / 2	DB 58 (5/8")
GMA-1* (Full Round) .020 und	GENERAL MOTORS	GMA-1-1 GMA-1-2	1 2,3,4,5	(LINE BORE MACHINING REQUIRED)		
GMA-2* (Half Shell)	GENERAL MOTORS	GMA-2-1 (U) GMA-2-3 (U) GMA-2-2 (L) GMA-2-1 (L)	1,6 2,3,4,5,7,8, 9,10 1,6 2,3,4,5,7,8,9,10	DBC12655	DBB11415 / 2	DB 78 (7/8")
HA-1* (Half Shell)	HONDA	HA-1-1 (U) HA-1-5 (L)	1,2,3,4,5 1,2,3,4,5	DBC12655	DBB11415 / 2	DB 78 (7/8")
HA-2* (Half Shell) .020 und	HONDA	HA-1-2 (U) HA-1-4 (U) HA-1-4A (U) HA-1-5 (U) HA-1-3 (L) HA-1-5 (L)	1 2,4,5 3 6 1 2,3,4,5,6	DBC12655	DBB11415 / 2	DB 78 (7/8")
HA-3* (Half Shell) .010 und .020 und	HONDA	HA-3-2 (U) HA-3-4 (U) HA-3-1 (L) HA-3-3 (L)	1 2,3,4,5,6 1 2,3,4,5,6	DBC11855	DBB1102 / 2	DB 58 (5/8")
HA-4* (Half Shell)	HONDA	HA-4-1 (U) HA-4-3 (U) HA-4-2 (L) HA-4-4 (L)	1 2,3,4,5 1 2,3,4,5	DBC12655	DBB11415 / 2	DB 78 (7/8")
HA-5* (Half Shell)	HONDA	HA-5-2 (U) HA-3-4 (U) HA-5-1 (L) HA-3-3 (L)	1 2,3,4,5,6,7 1 2,3,4,5,6,7	DBC12655 DBC11855	DBB11415 / 2 DBB1102 / 2	DB 78 (7/8") DB 58 (5/8")
MIA-1* (Half Shell) .010 und .020 und	HYUNDAI ISUZU MITSUBISHI	MIA-1-3 (U) MIA-1-1 (U) MIA-1-4 (L)	1 2,3,4,5 1,2,3,4,5	DBC14225	DBB13385 / 2	DB 78 (7/8")
MIA-2* (Half Shell) .020 und	HYUNDAI ISUZU MITSUBISHI	MIA-1-7 (U) MIA-1-5 (U) MIA-1-6 (L)	1 2,3,4,5 1,2,3,4,5	DBC14971	DBB13385 / 2	DB 78 (7/8")
MIA-3* (Full Round)	HYUNDAI MITSUBISHI	MIA-3-1	1,2,3	DBC18918	DBB18118 / 2	DB 78 (7/8")
MIA-4* (Half Shell)	MITSUBISHI	MIA-1-8 (U) MIA-1-1 (U) MIA-1-4 (L)	1,5 2,3,4, 1,2,3,4,5	DBC14225	DBB13385 / 2	DB 78 (7/8")

*Denotes (OHC) Repair Bearing, Check "Aluminum Overhead Cam Accessories" Section For Tool Information

**Denotes Auxiliary / Balance Shaft Bearing

"und" Denotes Undersized ID

ALUMINUM OVERHEAD CAM (OHC) ACCESSORIES

DURA-BOND QUICK BORE: BARS, BUSHINGS, AND CUTTERS

SET NO.	ENGINE MFG.	CONTENTS	POSITION	TOOLS		
				CUTTER	BUSHING / QTY	BAR
MIA-5* (Half Shell)	mitsubishi	MIA-5-1 (U) MIA-5-2 (U) MIA-5-3 (U) MIA-5-8 (U) MIA-5-5 (L) MIA-5-6 (L) MIA-5-7 (L) MIA-5-9 (L)	1 2 3 4 1 2 3 4	DBC14225	DBB13385 / 2	DB 78 (7/8")
MZA-1* (Full Round) .020 und	MAZDA	MZA-1-1 MZA-1-2 MZA-1-3	1 2 3	DBC17931	DBB17131 / 2	DB 78 (7/8")
MZA-2* (Half Shell) .020 und	MAZDA	MZA-2-3 (U) MZA-2-1 (U)	1,5 2,3,4	DBC13439	DBB12599 / 2	DB 78 (7/8")
MZA-4* (Half Shell)	MAZDA	MZA-4-1 (U) VHA-1-2 (L)	1,2,3,4,5 1,2,3,4,5	DBC12655	DBB11815 / 2	DB 78 (7/8")
NIA-1* (Full Round)	NISSAN	NIA-1-1	1,2,3,4,5	DBC17340	DBB16540 / 2	DB 78 (7/8")
NIA-2L* (Full Round)	NISSAN	NIA-2-1	1,2,3,4	DBC19309	DBB18509 / 2	DB 78 (7/8")
NIA-2R* (Full Round)	NISSAN	NIA-2-1	1,2,3,4,5	DBC19309	DBB18509 / 2	DB 78 (7/8")
NIA-3L* (Full Round)	NISSAN	NIA-2-1 NIA-3-2	1,2,3 4	DBC19309 DBC17538	DBB18509 / 2 DBB16737 / 1	DB 78 (7/8")
NIA-3R* (Full Round)	NISSAN	NIA-3-1 NIA-2-1 NIA-3-2	1 2,3,4 5	DBC19702 DBC19309 DBC17538	DBB18903 / 1 DBB18509 / 2 DBB16737 / 1	DB 78 (7/8")
NIA-4* (Full Round) .020 und	NISSAN	NIA-1-1 NIA-1-2 NIA-1-3	1,2,4 3 5	DBC17340	DBB16540 / 2	DB 78 (7/8")
NIA-5* (Full Round)	NISSAN	NIA-4-1 NIA-4-2	1,2,3,5 4	DBC18914	DBB18113 / 2	DB 78 (7/8")
NIA-6* (Half Shell) .020 und	NISSAN	TOA-1-1 (U) TOA-1-2 (L)	1,2,3,4,5 1,2,3,4,5	DBC13841	DBB13001 / 2	DB 78 (7/8")
PDA-1* (Half Shell)	CHRYSLER	PDA-1-2 (U) PDA-1-1 (L)	1,2,3,4,5 1,2,3,4,5	DBC14819	DBB13779 / 2	DB 78 (7/8")
PDA-2* (Half Shell)	CHRYSLER	PDA-2-2 (U) PDA-2-1 (L)	1,2,3,4,5 1,2,3,4,5	DBC14819	DBB13979 / 2	DB 78 (7/8")
PDA-3* (Full Round)	CHRYSLER	PDA-3-1 PDA-3-2 PDA-3-3 PDA-3-4 PDA-3-5	1 2 3 4 5	(LINE BORE MACHINING REQUIRED)		

*Denotes (OHC) Repair Bearing, Check "Aluminum Overhead Cam Accessories" Section For Tool Information

**Denotes Auxiliary / Balance Shaft Bearing

"und" Denotes Undersized ID

ALUMINUM OVERHEAD CAM (OHC) ACCESSORIES

DURA-BOND QUICK BORE: BARS, BUSHINGS, AND CUTTERS

SET NO.	ENGINE MFG.	CONTENTS	POSITION	TOOLS		
				CUTTER	BUSHING / QTY	BAR
PDA-4* (Half Shell) .010 und	CHRYSLER	PDA-4-2 (U) PDA-4-1 (L)	1,2,3,4,5 1,2,3,4,5	DBC11085	DBB10225 / 2	DB 58 (5/8")
SA-1* (Full Round)	SUZUKI	SA-1-1 SA-1-2 SA-1-3 SA-1-4 SA-1-5	1 2 3 4 5	(LINE BORE MACHINING REQUIRED)		
TOA-1* (Half Shell)	TOYOTA	TOA-2-2 (U) TOA-2-1 (L)	1,2,3 1,2,3	DBC13841	DBB13001 / 2	DB 78 (7/8")
VOA-1* (Half Shell)	VOLVO	VHA-1-2 (U) VOA-1-1 (L)	1,2,3,4,5 1,2,3,4,5	DBC12655	DBB11815 / 2	DB 78 (7/8")
VWA-1* (Half Shell)	AUDI	VWA-1-1 (U) VWA-1-2 (U) VWA-1-4 (U) MZA-2-3 (L) VWA-1-5 (L) VWA-1-3 (L)	1 2,3 4 1 2,3 4	DBC13439 DBC12655	DBB12599 / 1 DBB11815 / 2	DB 78 (7/8")
VWA-2* (Half Shell) .010 und .020 und .030 und .040 und	VOLKSWAGEN	VWA-2-1 (U) VWA-2-2 (L)	1,2,3,4,5 1,2,3,4,5	DBC11085	DBB10225 / 2	DB 58 (5/8")

*Denotes (OHC) Repair Bearing, Check "Aluminum Overhead Cam Accessories" Section For Tool Information

**Denotes Auxiliary / Balance Shaft Bearing

"und" Denotes Undersized ID



VALVE SEAT TECHNOLOGY

Valve Seat Technology Has Changed.

Modern engines put much higher levels of thermal and mechanical stress on valve seat inserts. To handle the more severe conditions within this new generation of engines, the OEM is equipping them with high tech sintered valve seats. The normal cast chrome and other alloy iron seats will not adequately withstand the demands of this new engine environment.

Dura-Bond's patented material and processing of these powder metal valve seats offer excellent machinability, along with low wear and high heat resistance. These inserts have finely dispersed tungsten carbide residing in a matrix of tempered tool steel and special alloy iron particles to provide all the properties an application requires. Special compositions and processing have been developed to perform in the most extreme duty applications. Complete in-house capabilities, from development and tooling to testing, reduces lead time and cost.

If your requirements range from prototypes to high volume, let Dura-Bond Bearing Company be part of the solution.



Dura-Bond Bearing Company · 3200 Arrowhead Dr., Carson City, NV 89706 · Tel (800) 227-8360 · Fax (775) 883-9497
BE SURE TO VISIT US ONLINE AT WWW.DURA-BONDBEARING.COM



30000 (GOLD) SERIES VALVE SEAT INSERTS

DESCRIPTION and APPLICATION

Superior Machinability

The 30000 (Gold) series is the newest and most machinable of our valve seat materials. It is a sintered valve seat insert which offers a blend of finely dispersed tungsten carbide residing in a matrix of tempered tool steel and special alloy iron particles. The superior machinability is the result of adding our proprietary ingredients and solid dry lubricants to this blend, and by using our special processing techniques during manufacture.

Designed for Unleaded Fuels

This very machinable exhaust seat material is designed for unleaded fuels. The 30000 (Gold) series is intended for the light to medium duty range. (For the heavy duty or extreme duty range we recommend our 70000 (Diamond) series valve seat inserts.)

New Powder Metal Technology

Dura-Bond/Snyder has taken full advantage of the new powder metal technology to produce a "hard" valve seat which will machine almost like cast iron. The greatly enlarged picture (the 4 black squares are .0015" across) tells the story.

- Powder metal technology allows us to place a special high grade alloy iron (with its natural, tool lubricating graphite rich properties) within a tempered tool steel matrix.
- Because of our special processing, we are able to get very fine, spheroidalized, tungsten carbide particles to evenly disperse within the tool steel.
- These spheroidalized (round shaped) carbides are easier to machine because the tool bit can wedge in-between, with less cutting force and less friction.
- The smaller these "balls" of carbide, the easier it is on your cutting tool, because it will not be hitting any big irregular shaped "iceberg chunks" of carbide.

CHEMICAL COMPOSITION

Tungsten	3.8
Molybdenum	3.5
Chromium	2.0
Vanadium	1.0
Carbon	0.9
Cobalt	0.3
Nickel	0.4
Manganese	0.3
Silicon	0.2
Copper	0.1
(proprietary)	4.5
Iron	rem.

PHYSICAL PROPERTIES

Apparent hardness	20 HRC (approx.)
Micro hardness	20-43 HRC
Thermal expansion	.0000075"/F
(at 1000° F)	

Special alloy iron
(large white area)

Simi steel
(darker outline)

Micro hardness
penetrator

Tool steel matrix

Tungsten carbides
(small white dots
within tool steel
matrix)

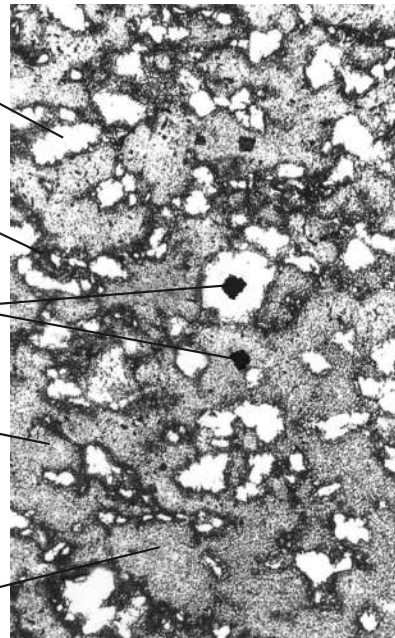

Dura-Bond reserves the right to revise composition and specifications without notice.



70000 (Diamond) 90000*(Platinum) SERIES VALVE SEAT INSERTS

DESCRIPTION and APPLICATION

This is a sintered, high speed (tungsten carbide) tool steel, valve seat insert. This material has special additives blended into the matrix which impart high temperature lubrication properties to the valve seat. These lubrication properties are "built-in" throughout, and are not affected by extreme heat or machining. These solid lubricants enable this material to be used in "dry" fuel applications such as propane, LPG, and natural gas. They prevent the "micro-welding" of the valve seat material to the valve face, therefore eliminating the primary cause of valve seat erosion. They also improve the machinability. Your tools last longer and you can cut faster.

Because of the special high temperature sintering and post heat treat processing, this valve seat material has cermet style metal alloy oxides. This gives it superior wear resistance to both pounding and abrasive wear at elevated temperatures. These** are called "cer-met" style because they are similar to **ceramic** (they do not soften at elevated temperature), but retain the machinability of **metal**. It is this high tech, new generation processing that allows us to achieve such high, hot hardness without having to put in massive amounts of expensive alloys, which would be required, to achieve equal performance. Normal foundry techniques do not allow this type of structure. You get superior wear resistance and high hot hardness at a very favorable price.

This valve seat insert is, therefore, used in engines using diesel, unleaded gasoline, and propane. We have been setting new longevity records in propane and natural gas applications using this seat.

The micro structure of this valve seat insert is a very fine evenly dispersed mixture of spheroidal refractory alloy carbides, cermet style metal alloy oxides and solid lubricant residing in a tempered martensitic matrix.

CHEMICAL COMPOSITION

	70000	90000*
Tungsten	5.3	6.5
Molybdenum	4.4	6.0
Chromium	3.5	4.0
Vanadium	1.5	2.0
Carbon	0.8	0.9
Cobalt	0.4	0.4
Nickel	0.3	0.4
Manganese	0.3	0.3
Silicon	0.2	0.2
Copper	0.1	0.1
(proprietary)	3.5	3.5
Iron	rem.	rem.

PHYSICAL PROPERTIES

	70000	90000*
Apparent hardness	30 HRC (approx.)	35 HRC (approx.)
Micro Hardness	25-43 HRC	35-43 HRC
Thermal expansion (at 1000° F)	.0000078"/degree F	.0000078"/degree F

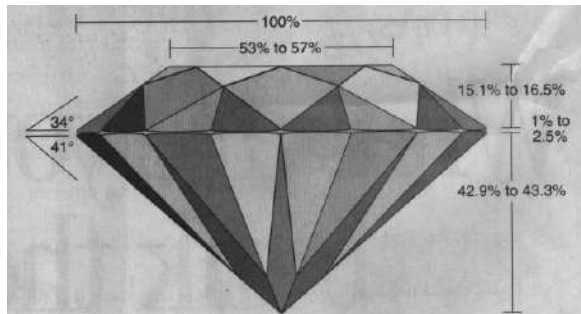

**Metal Alloy Oxides

* 90000 series available for extreme duty applications, special order only.

Dura-Bond reserves the right to revise composition and specifications without notice.

"KILLER BEE" COPPER INFILTRATED VALVE SEAT INSERTS



DESCRIPTION and APPLICATION

GM is equipping the LS3 heads with high tech sintered copper-infiltrated valve seats. High-Performance European engines like BMW and Mercedes also use this technology. This is a powder metal valve seat with a copper wafer that is infiltrated into the valve seat. This creates a unique product of 15% free copper in the microstructure of the seat. Allowing heat to be quickly transferred and performance greatly improved.

- Offers superior thermal conductivity
- Excellent machining characteristics
- Lowest wear - Improved reliability/durability
- High thermal expansion
- Superior surface finishes
- Suitable for HD intake and exhaust seats, gas and diesel
- Compatible with most valve materials

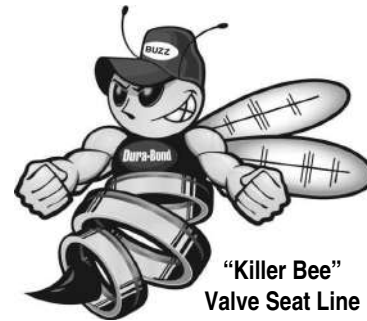

<u>CHEMICAL COMPOSITION</u>	<u>"Killer Bee"</u>	<u>GM LS-3</u>	<u>PHYSICAL PROPERTIES</u>	
Tungsten	3.0	3.68	Apparent Hardness	35 HRC (approx.)
Molybdenum	3.375	2.5	Micro Hardness	50-56 HRC
Chromium	2.0	1.84	Thermal Expansion	
Vanadium	1.0	1.44		
Carbon	1.0	0.84		
Cobalt	0.28	0.24		
Nickel	0.205	0.13		
Manganese	0.35	0.58		
Silicon	0.2	NA		
Copper	15	14.45		
(proprietary)	4.5	NA		
Iron	bal.	bal.		

Dura-Bond reserves the right to revise composition and specifications without notice.

VALVE SEAT NUMERICAL LISTING BY PART NUMBER

PART NUMBER SERIES				ACTUAL		ID TOP		SEAT
30000	70000	90000	"Killer Bee"	OD	ID	TAPER	DEPTH	ANGLE
30015				1.5050	1.215	1.275	.280	45°
30024				1.5050	1.250	1.390	.240	45°
30030				1.8190	1.490	1.600	.305	45°
30031				1.5070	1.180	1.318	.305	45°
30045				1.5050	1.100	1.225	.316	45°
30105	70105			1.5050	1.140	1.250	.325	45°
	70127			1.7570	1.385	1.559	.380	45°
	70138			1.8820	1.505	1.689	.380	45°
30165				1.7570	1.410	1.560	.315	45°
30190				1.6940	1.385	1.520	.305	45°
30230				1.2570	0.905	1.000	.230	45°
30238	70238			1.3820	1.102	1.160	.260	45°
30297				1.9800	1.694		.250	45°
30503	70503			1.5680	1.312	1.390	.250	45°
30509	70509			1.8800	1.562		.250	45°
30530	70530			1.8180	1.500	1.625	.219	45°
30537	70537			2.1300	1.875		.250	45°
30541	70541			1.5680	1.312	1.390	.219	45°
	70542			1.8170	1.562	1.655	.365	45°
30556	70556			1.4440	1.250		.219	45°
30557	70557			2.1300	1.812		.250	45°
30558	70558			1.3800	1.125		.219	45°
30559	70559			1.6925	1.344		.313	45°
30560	70560			1.9440	1.688		.250	45°
30562				1.3190	1.085		.305	45°
	70563			1.3190	1.045		.316	45°
30640	70640			1.5680	1.250		.219	45°
	70642			1.6300	1.334		.313	45°
30643	70643	90643	30643C	1.5680	1.312		.219	45°
30643+5	70643+5			1.5730	1.312		.219	45°
30644	70644			1.5680	1.312		.250	45°
30644+10				1.5780	1.313		.250	45°
30645	70645			1.5680	1.250		.250	45°
30646	70646			1.6300	1.375		.250	45°
30647	70647			1.5680	1.250		.313	45°
30648	70648			1.6300	1.375		.219	45°
30648+5				1.6350	1.375		.219	45°
30649	70649	90649		1.6300	1.313		.219	45°
30650	70650			1.6300	1.313		.250	45°
30651	70651			1.6300	1.313		.313	45°
30652	70652			1.7550	1.375		.219	45°
30653	70653			1.7550	1.375		.250	45°
30654	70654			1.7550	1.375		.313	45°
30655	70655			1.7550	1.438		.219	45°
30656	70656			1.7550	1.438		.250	45°
30657	70657			1.7550	1.438		.313	45°
30658	70658			1.7550	1.500		.219	45°
30659	70659	90659	20659C	1.7550	1.500		.250	45°
	70660			1.7550	1.500		.313	45°
30661	70661			1.6300	1.250		.219	45°
30662	70662			1.6300	1.250		.250	45°
30663	70663			1.6300	1.250		.313	45°
30664	70664			1.6920	1.438		.219	45°
	70664+5			1.6970	1.438		.219	45°
30667	70667			1.8180	1.563		.219	45°
30668	70668			1.8180	1.500		.219	45°
30670	70670			1.6920	1.406		.250	45°

* Special ID Features

VALVE SEAT NUMERICAL LISTING BY PART NUMBER

PART NUMBER SERIES				ACTUAL	ID	ID TOP	DEPTH	SEAT
30000	70000	90000	"Killer Bee"	OD	ID	TAPER	DEPTH	ANGLE
30671	70671			1.8180	1.563		.250	45°
30672	70672			1.8180	1.500		.250	45°
30673	70673			1.6920	1.438		.250	45°
30674	70674			1.6920	1.312		.219	45°
30675	70675			1.6920	1.312		.250	45°
30676	70676			1.6920	1.312		.313	45°
30677	70677			1.6920	1.375		.219	45°
30678	70678			1.6920	1.375		.250	45°
30679	70679			1.6920	1.375		.313	45°
30680	70680	90680		1.8180	1.468		.313	45°
30681	70681			1.8810	1.625		.219	45°
30682	70682			1.8810	1.625		.250	45°
30683				1.8810	1.625		.281	45°
30684	70684			1.8810	1.625		.313	45°
	70686			1.8810	1.625		.453	45°
30687	70687			1.8810	1.594		.250	45°
30688	70688			1.8810	1.594		.313	45°
30690	70690			2.0060	1.750		.188	45°
30691	70691			2.0060	1.750		.219	45°
30692	70692			2.0060	1.750		.250	45°
30694				2.0060	1.750		.313	45°
30698	70698			2.0060	1.688		.219	45°
30699	70699			2.0060	1.688		.250	45°
30700	70700			2.0060	1.688		.282	45°
30701				2.0060	1.688		.313	45°
30702				2.0060	1.688		.375	45°
30703				2.0060	1.688		.438	45°
30705	70705			1.5050	1.215	1.344	.219	45°
30706	70706			1.5050	1.125		.188	45°
30707	70707			1.5050	1.125		.219	45°
30708				1.5050	1.125		.250	45°
30709	70709			1.5050	1.125		.313	45°
	70710			1.5050	1.250		.188	45°
30711	70711			1.5050	1.250		.219	45°
30712	70712			1.5050	1.250		.250	45°
30714	70714			1.5050	1.250		.313	45°
30715				1.5050	1.250		.375	45°
30716				1.5050	1.215		.310	45°
	70717			1.5050	1.215		.318	45°
30721				1.5050	1.215		.305	45°
30722	70722			1.5050	1.215		.250	45°
30723				2.0060	1.625		.219	45°
30724	70724			2.0060	1.625		.250	45°
30725		90725		2.0060	1.625		.281	45°
		90725+5		2.0110	1.625		.281	45°
		90725+10		2.0160	1.625		.281	45°
		90725+20		2.0260	1.625		.281	45°
		90725+30		2.0360	1.625		.281	45°
	70726			2.0060	1.625		.297	45°
30727	70727			2.0060	1.625		.313	45°
30728				2.0060	1.625		.344	45°
30729	70729			2.0060	1.625		.375	45°
30730				2.0060	1.625		.438	45°
30731				1.5680	1.312		.313	45°
30732	70732			1.6300	1.375		.313	45°
30733	70733			1.6920	1.438		.313	45°
30735				1.3170	1.046		.219	45°

* Special ID Features

VALVE SEAT NUMERICAL LISTING BY PART NUMBER

PART NUMBER SERIES				ACTUAL		ID TOP		SEAT
30000	70000	90000	"Killer Bee"	OD	ID	TAPER	DEPTH	ANGLE
30736				1.3170	1.046		.250	45°
30737				1.3170	1.046		.313	45°
30738				1.4850	1.260		.237	45°
30739				1.3050	1.048		.227	45°
30740	70740			1.5680	1.250		.281	45°
30741				1.8180	1.500		.281	45°
30754				1.1300	0.875		.219	45°
30764	70764			1.2550	1.000		.250	45°
30775				1.3190	1.062		.188	45°
30779	70779			1.3190	1.042		.238	45°
30786	70786			1.3800	1.063		.188	45°
30787	70787			1.3800	1.063		.313	45°
30788	70788			1.3800	1.063		.250	45°
30790	70790			1.3800	1.125		.188	45°
30791	70791			1.3800	1.125		.250	45°
	70792			1.3800	1.125		.375	45°
30801	70801			1.4425	1.126		.219	45°
30802	70802			1.4425	1.125		.250	45°
30803	70803			1.4425	1.125		.313	45°
30806				1.4440	1.105		.322	45°
30809				1.4440	1.135	1.250	.316	45°
30818				1.4440	1.200		.297	45°
30822	70822			1.5050	1.188		.250	45°
30823				1.5050	1.188		.218	45°
	70838			1.5680	1.313		.219	30°
30839	70839			1.5680	1.188		.313	45°
30840	70840			1.5680	1.313		.188	45°
30841				1.5680	1.375		.218	45°
30853	70853			1.6300	1.250		.375	45°
30854	70854			1.6300	1.313		.395	45°
	70855			1.6245	1.322		.375	45°
30857				1.6300	1.348		.218	45°
30860	70860			1.6320	1.329		.280	45°
30864	70864			1.6450	1.375		.250	45°
30868				1.6690	1.372	1.429	.272	37°
30871	70871			1.6920	1.375		.375	45°
30872				1.6920	1.438		.156	45°
30873	70873			1.6920	1.438		.188	45°
30881				1.6940	1.450		.297	45°
30889				1.7550	1.313		.250	45°
	70903			1.8170	1.375		.313	45°
30904				1.8180	1.438		.250	45°
30905	70905			1.8170	1.438		.313	45°
30907	70907	90907	20907C	1.8180	1.500		.312	45°
30919	70919			1.8800	1.500		.250	45°
30920	70920			1.8810	1.500		.313	45°
30923	70923			1.8800	1.562		.312	45°
30932	70932			1.9430	1.563		.250	45°
30933	70933			1.9430	1.563		.219	45°
30935				1.9430	1.688		.188	45°
30936				1.9430	1.688		.219	45°
30952	70952			2.0050	1.813		.219	45°
30963	70963			2.0680	1.812		.250	45°
30964				2.0680	1.813	1.875	.250	45°
30974				2.1300	1.875		.219	45°
30984	70984			2.1935	1.875		.281	45°
30989	70989			2.2555	1.938		.188	45°

* Special ID Features

VALVE SEAT NUMERICAL LISTING BY PART NUMBER

PART NUMBER SERIES				ACTUAL	ID	ID TOP	DEPTH	SEAT
30000	70000	90000	"Killer Bee"	OD	ID	TAPER	DEPTH	ANGLE
30991	70991	90991		2.3180	2.000		.250	45°
31000	71000			1.8180	1.563		.313	45°
31002	71002			0.9890	0.787		.236	45°
31003	71003			1.0512	0.787		.224	45°
	71004			1.1858	0.984		.248	45°
31005	71005			1.1870	0.984		.248	45°
31006	71006			1.2854	1.004		.315	45°
31007	71007			1.2854	1.024		.335	45°
	71008	91008		1.3051	1.102		.276	45°
31009	71009			1.3268	1.063		.315	45°
31010	71010	91010		1.3268	1.126		.250	45°
	71011			1.3484	1.126		.250	45°
31012	71012			1.4016	1.142		.315	45°
31013	71013			1.4421	1.126		.315	45°
31014				1.4823	1.220		.276	45°
31015	71015			1.4843	1.220		.315	45°
31016	71016			1.5335	1.221		.335	45°
	71017			1.5827	1.339		.295	45°
	71018			1.5984	1.339		.276	45°
31019	71019			1.6386	1.339		.315	45°
	71020			1.6417	1.339		.250	45°
31021	71021			1.7028	1.417		.315	45°
31030	71030			1.4425	1.188		.219	45°
31031	71031			1.4425	1.219		.219	45°
31032				1.5045	1.188		.313	45°
31033				1.5670	1.344		.219	45°
31034	71034			1.8820	1.575	1.692	.317	45°
31035	71035			1.3634	0.984		.394	45°
	71036			1.5248	1.183		.394	45°
31038	71038			1.4961	1.181		.276	45°
31039	71039			1.6142	1.339		.295	45°
31042				1.6920	1.375		.188	45°
31043	71043			1.2550	1.028		.227	45°
31044	71044			1.4750	1.240		.227	0°
31045				1.7560	1.438	1.500	.188	45°
31046	71046			1.6310	1.375		.188	45°
31047	71047			1.0690	0.790		.260	45°
31048	71048			1.1320	0.825		.285	45°
31049	71049			1.1819	0.925		.244	45°
31051	71051			1.2008	0.984		.256	45°
31052				1.2550	1.055		.250	45°
31054	71054			1.2570	0.910		.285	45°
31056				1.3175	1.000		.250	45°
31058				1.3190	0.975		.280	45°
31060	71060			1.3484	1.063		.315	45°
31061	71061			1.3661	1.114		.295	45°
31063				1.3820	1.000		.410	45°
31064				1.3820	1.000		.280	45°
31065	71065			1.3878	1.102		.315	45°
31066	71066			1.4220	1.152		.315	45°
31067				1.4440	1.230		.250	45°
31068	71068			1.4567	1.102		.354	45°
31069	71069			1.4567	1.181		.315	45°
31070	71070			1.4646	1.181		.276	45°
31071				1.4764	1.220		.335	45°
31073	71073			1.5051	1.220		.315	45°
31074				1.5070	1.100		.315	45°

* Special ID Features

VALVE SEAT NUMERICAL LISTING BY PART NUMBER

PART NUMBER SERIES				ACTUAL		ID TOP		SEAT
30000	70000	90000	"Killer Bee"	OD	ID	TAPER	DEPTH	ANGLE
31075	71075			1.5472	1.260		.315	45°
31076	71076			1.5551	1.299		.335	45°
31077				1.5673	1.250		.253	45°
31078				1.5690	1.230		.310	45°
31079				1.5690	1.180		.305	45°
31081	71081			1.5823	1.180		.413	45°
31082	71082			1.6614	1.319		.413	45°
31083				1.6940	1.300		.360	45°
31084	71084			1.7059	1.384		.354	45°
	71085			1.7059	1.384		.250	45°
31086	71086			1.7421	1.457		.315	45°
31087	71087			1.7863	1.406		.288	45°
31088	71088			1.7969	1.418		.390	45°
31089				1.8170	1.484		.250	45°
31090	71090			1.8303	1.437		.375	45°
31091	71091		31091C	1.8800	1.500		.375	45°
31092	71092			1.8820	1.600		.252	45°
31093	71093			2.1098	1.697		.402	45°
31096				1.0681	0.871		.254	45°
31097				1.1299	0.871		.191	45°
31098				1.1933	0.871		.254	45°
31099				1.1933	0.933		.254	45°
31100				1.2559	0.996		.254	45°
31101	71101			1.3181	1.059		.254	45°
31102				1.3807	1.059		.254	45°
31103				1.3807	1.121		.254	45°
31104				1.5681	1.183		.254	45°
31105	71105			1.2559	0.933		.254	45°
31107				1.4433	1.059		.254	45°
31108				1.5059	1.183		.254	45°
31109	71109			1.5059	1.246		.254	45°
31110				1.7333	1.335		.372	45°
31111	71111			1.4405	1.186		.313	45°
31112	71112			1.5657	1.186		.376	45°
31113				1.4577	1.098		.352	45°
31117				1.7550	1.438	1.500	.302	45°
	71121			1.4252	1.220		.295	45°
	71123			1.3071	1.083		.276	45°
31124				2.1300	1.813		.313	45°
31125	71125			1.3800	1.062		.219	45°
	71128			1.7550	1.250		.250	45°
31129	71129			1.7570	1.375		.375	45°
31131	71131			1.8170	1.500		.375	45°
31134	71134			1.9430	1.625		.312	45°
31135				2.1940	1.812		.250	45°
31137	71137			1.8190	1.405		.315	45°
31139	71139			1.3820	1.100		.300	45°
31141	71141			2.1654	1.732		.472	45°
	71142			1.0690	0.781		.250	45°
31143	71143			1.1310	0.750		.250	45°
	71144			1.1940	0.875		.250	45°
31145	71145			1.1940	0.938		.250	45°
31146	71146			1.1940	0.905		.257	45°
31147	71147			1.2560	1.000		.219	45°
	71148			1.2560	1.000		.313	45°
31149	71149			1.2560	0.906		.313	45°
	71150	91150		1.2560	1.000		.250	45°

* Special ID Features

VALVE SEAT NUMERICAL LISTING BY PART NUMBER

PART NUMBER SERIES				ACTUAL	ID	ID TOP	DEPTH	SEAT
30000	70000	90000	"Killer Bee"	OD	ID	TAPER	DEPTH	ANGLE
31151	71151			1.2560	0.875		.250	45°
31152	71152			1.2560	0.938		.188	45°
31153	71153			1.3190	1.063		.313	45°
	71154			1.3190	1.000		.250	45°
31155	71155			1.3190	1.000		.313	45°
	71156			1.3810	0.938		.313	45°
31157	71157			1.3810	1.125		.266	45°
	71159			1.4440	1.188		.219	45°
31160	71160			1.4440	1.250		.313	45°
31161	71161			1.4440	1.188		.250	45°
31162	71162			1.5060	1.188		.313	45°
	71163			1.5690	1.125		.313	45°
31164	71164			1.6310	1.344		.313	45°
	71165			1.7560	1.313		.313	45°
31166	71166			1.9440	1.500		.313	45°
	71167			0.9449	0.709		.256	45°
	71168			1.1024	0.787		.315	45°
	71169			1.1417	0.827		.335	45°
31170	71170			1.1811	0.866		.335	45°
31171	71171			1.2205	0.906		.335	45°
	71172			1.2598	0.945		.335	45°
31173	71173			1.2992	0.984		.335	45°
31174	71174			1.3386	1.024		.335	45°
	71175			1.3780	1.024		.354	45°
	71176			1.4173	1.063		.354	45°
	71178			1.4961	1.142		.354	45°
	71179			1.5354	1.181		.354	45°
	71180			1.5354	1.220		.335	45°
	71181			1.5748	1.181		.374	45°
	71182			1.6142	1.220		.335	45°
31183	71183			1.6535	1.260		.374	45°
	71184			1.6535	1.299		.335	45°
	71185			1.6929	1.339		.325	45°
31186	71186	91186		1.6929	1.299		.335	45°
31187	71187			1.7323	1.339		.374	45°
	71188			1.8110	1.398		.394	45°
	71189			1.8890	1.476		.394	45°
	71190			1.9291	1.516		.394	45°
	71191			1.9291	1.654		.315	45°
	71192			1.9685	1.535		.394	45°
	71193			2.0079	1.575		.413	45°
31194	71194			2.0472	1.614		.413	45°
31195	71195	91195		2.0866	1.654		.413	45°
31196				1.6250	1.313		.250	45°
31198				1.5000	1.188		.250	45°
31199	71199			1.5685	1.255	1.372	.319	45°
	71207			1.5060	1.180	1.280	.214	45°
31209				1.7560	1.594		.278	45°
31214				1.5060	1.210		.345	45°
31215				1.7560	1.445	1.617	.310	45°
31217				1.8810	1.575		.317	45°
31218				1.6310	1.298		.317	45°
	71221			1.7560	1.437		.302	45°
31223				1.6310	1.320		.300	45°
31225	71225			1.4425	1.126		.188	45°
31226				1.6460	1.312		.350	45°
	71227			1.7717	1.358		.394	45°

* Special ID Features

VALVE SEAT NUMERICAL LISTING BY PART NUMBER

PART NUMBER SERIES				ACTUAL		ID TOP		SEAT
30000	70000	90000	"Killer Bee"	OD	ID	TAPER	DEPTH	ANGLE
31228	71228			1.8504	1.437		.394	45°
	71230			1.7840	1.469		.290	45°
31232				1.7550	1.312		.395	45°
31236				1.6320	1.298	1.422	.317	45°
31238	71238			1.8810	1.563		.219	45°
31240	71240			2.1310	1.813		.219	45°
31244				1.5060	1.230		.278	45°
31249	71249			2.0685	1.750		.219	45°
	71257	91257		1.7810	1.476		.311	45°
31258	71258			1.5060	1.180	1.345	.307	45°
	71261			2.2560	1.938		.219	45°
31262				1.9435	1.625		.219	45°
	71267			1.5680	1.313		.280	45°
	71268			1.8560	1.635		.280	45°
31269	71269			1.8180	1.438		.219	45°
31270				1.6920	1.312		.375	45°
31272				1.6560	1.313		.375	45°
31273	71273	91273		1.3386	1.063		.394	45°
31274	71274			1.3976	1.142		.394	45°
31275				1.4567	1.220		.394	45°
31276	71276	91276		1.4961	1.220		.394	45°
31278				1.5827	1.319		.374	45°
31279				1.6560	1.350	1.626*	.375	45°
31281				1.9435	1.573		.379	45°
31282				2.1930	1.937		.250	45°
31283				1.8175	1.625		.219	45°
31284				1.8195	1.440	1.515	.315	45°
31285				1.8195	1.500	1.555	.278	45°
31286				1.5695	1.265	1.320	.280	45°
31287	71287			1.5695	1.219		.317	45°
31288				1.6945	1.390	1.480	.305	45°
31289	71289			1.3170	1.063		.219	45°
31291				1.5070	1.210	1.276	.345	45°
31292				1.5695	1.220	1.356	.344	45°
31293				1.3189	1.063		.354	45°
31294				1.3976	1.161		.374	45°
31295				1.5591	1.319		.374	45°
31296				1.5748	1.319		.354	45°
	71305			1.4777	1.213		.154	45°
	71306			1.3387	1.102		.177	45°
31307				1.8190	1.496		.157	45°
31308				1.6694	1.339		.177	45°
31310				2.1050	1.765		.375	45°
	71311	91311		1.2598	0.945		.354	45°
31313				1.2670	0.982	1.065	.320	45°
31316				1.8820	1.575		.320	45°
31317				1.7570	1.457		.312	45°
31318				1.5700	1.243		.354	45°
31319				1.8200	1.435	1.505	.314	45°
31320	71320			1.3190	1.123		.300	45°
31323				1.6340	1.260	1.340	.394	45°
31326				1.5060	1.195		.315	45°
31327				1.8190	1.440	1.508	.316	45°
31329				1.4440	1.100		.315	45°
31332				1.6320	1.250		.312	45°
31333				1.2560	0.910	1.070	.281	45°
	71338	91338		2.1339	1.693		.339	45°

* Special ID Features

VALVE SEAT NUMERICAL LISTING BY PART NUMBER

PART NUMBER SERIES				ACTUAL	ID	ID TOP	DEPTH	SEAT
30000	70000	90000	"Killer Bee"	OD	ID	TAPER	DEPTH	ANGLE
31340 31341	71339	91348		1.8567	1.457		.339	45°
				1.3190	0.977		.300	45°
				2.0276	1.726		.217	45°
	71342			1.5043	1.188		.313	45°
	71343			1.5043	1.250		.281	45°
	71344			1.5669	1.250		.313	45°
	71345			1.1850	0.984		.248	45°
	71346			0.9882	0.787		.236	45°
	71347			1.2724	1.024		.236	45°
	71348			1.2992	1.024		.256	45°
	71349			0.9902	0.787		.236	45°
	71350			1.0559	0.807		.224	45°
	71352			1.1921	0.875		.250	45°
	71353			1.4791	1.187		.313	45°
	71354			1.2252	0.910		.283	45°
	71355			1.8161	1.505		.280	45°
	71356			1.3504	1.063		.315	45°
	71357			0.9252	0.709		.236	45°
	71358			1.1661	0.809		.280	45°
	71359			1.2551	1.000		.250	45°
	71360			1.2854	0.984		.236	45°
	71361			1.3433	1.025		.299	45°
	71362			1.3701	1.142		.283	45°
	71363			1.3803	1.093		.250	45°
	71364			1.4421	1.125		.354	45°
	71365			1.4685	1.142		.315	45°
	71366			1.5008	1.148		.283	45°
	71367			1.5051	1.122		.343	45°
	71368			1.5157	1.220		.343	45°
	71369			1.5354	1.181		.276	45°
	71370			1.5354	1.299		.315	45°
	71371			1.6000	1.282		.299	45°
	71372			1.6260	1.320		.375	45°
	71373			1.6772	1.417		.315	45°
	71374			1.6921	1.312		.315	45°
	71375			1.7323	1.417		.276	45°
	71376			1.8150	1.392		.297	45°
	71377			1.8661	1.535		.315	45°
	71378			1.8740	1.435		.382	45°
	71379			1.4803	1.287		.283	45°
71380	1.4421	1.125		.250	45°			
71381	1.7559	1.378		.295	45°			
71382	1.0472	0.827		.236	45°			
71383	1.0689	0.787		.236	45°			
71384	1.2441	1.024		.236	45°			
71385	1.3425	1.083		.236	45°			
71386	1.4764	1.240		.335	45°			
71387	1.4862	1.220		.335	45°			
71388	1.5157	1.220		.335	45°			
71389	1.5256	1.220		.335	45°			
71390	1.6831	1.469		.295	45°			
71391	1.6929	1.385		.315	45°			
71392	1.7618	1.457		.335	45°			
71393	1.7717	1.457		.335	45°			
71394	1.8819	1.575		.315	45°			
71395	1.0551	0.827		.244	45°			
71396	1.1083	0.866		.256	45°			

* Special ID Features

VALVE SEAT NUMERICAL LISTING BY PART NUMBER

30000	PART NUMBER SERIES			ACTUAL	ID	ID TOP TAPER	DEPTH	SEAT ANGLE
	70000	90000	"Killer Bee"	OD				
	71397			1.3228	1.082		.287	45°
	71398			1.0335	0.827		.177	45°
	71399			1.4114	1.181		.244	45°
	71400			1.4803	1.200		.276	45°
31401	71401			2.0673	1.693		.354	45°
31402	71402			1.4421	1.188		.250	45°
	71403			1.2827	1.063		.236	45°
	71404			1.7815	1.496		.315	45°
	71406			1.6929	1.350		.315	45°
	71407			1.4429	1.130		.315	45°
	71408			1.3780	1.102		.197	45°
	71409			1.2480	1.024		.256	45°
	71410	91410		1.1496	0.906		.256	45°
	71411			1.1811	0.945		.335	45°
	71412			1.4236	1.152		.250	45°
	71413			1.6201	1.374		.256	45°
	71414			1.2303	0.984		.315	45°
	71415			2.0079	1.575		.217	45°
	71416			1.5410	1.327		.256	45°
	71417			2.1339	1.752		.287	45°
	71418			1.5846	1.358		.287	45°
	71419			1.5059	1.280		.295	45°
	71420			1.4272	1.142		.315	45°
	71421			1.6634	1.378		.315	45°
	71422			1.5630	1.299		.339	45°
	71423			1.4055	1.181		.339	45°
31424	71424			2.0906	1.693		.394	45°
	71425			1.2992	0.905		.315	45°
	71426			1.5413	1.366		.232	45°
	71427			1.7874	1.409		.297	45°
	71428			1.1024	0.807		.256	45°
	71429			1.0898	0.874		.250	45°
	71430			2.0906	1.693		.354	45°
	71431			1.1516	0.874		.250	45°
31433	71432			1.5209	1.220		.285	45°
	71433			1.8358	1.496		.285	45°
	71434			1.2407	0.941		.335	45°
	71435			1.1933	0.929		.256	45°
	71436			1.1870	0.945		.354	45°
	71437			1.6220	1.319		.260	45°
	71438			1.3307	1.126		.250	45°
	71439			1.4449	1.142		.315	45°
	71440			1.4449	1.220		.295	45°
	71441			2.1102	1.693		.394	45°
	71442			1.5630	1.299		.354	45°
	71444			1.1732	0.945		.236	45°
	71445			1.1870	0.984		.200	45°
	71446			0.9843	0.787		.276	45°
	71447			2.1102	1.693		.354	45°
	71448			1.2205	0.984		.237	45°
		91449		1.3445	1.102		.236	45°
		91450		1.2736	0.906	1.024	.248	45°
31454				2.1200	1.812		.375	45°
31456				2.3500	1.970	2.290*	.375	53°
31459				1.8175	1.438		.375	45°
	71470			2.2555	1.875		.313	45°
31471				1.9430	1.625		.375	45°

* Special ID Features

VALVE SEAT NUMERICAL LISTING BY PART NUMBER

30000	PART NUMBER SERIES			ACTUAL	ID	ID TOP TAPER	DEPTH	SEAT ANGLE
	70000	90000	"Killer Bee"	OD				
	71472			1.7815	1.535		.295	45°
	71473			2.1300	1.906		.234	45°
31475				2.0902	1.697		.382	45°
31476				2.3657	2.011		.350	45°
31478				1.6565	1.246	1.546*	.375	55°
31482				1.6300	1.406		.250	45°
31488	71488			1.6300	1.313		.281	45°
31489	71489			1.6300	1.344		.250	45°
31490				1.6925	1.406		.313	45°
	71496			1.9430	1.563		.313	45°
31497	71497			1.9430	1.625		.250	45°
31498	71498			2.1305	1.906		.250	45°
31501				1.5060	1.195		.360	45°
	71502			1.2820	0.975		.250	45°
	71503			1.7140	1.313		.313	45°
	71504			2.1370	1.700		.400	45°
	71600			1.0045	0.750		.188	45°
31612				1.2570	0.930		.325	45°
31613				1.2570	0.970		.270	45°
	71621			1.2620	0.975		.250	30°
31628	71628			1.3195	1.060		.275	45°
	71633+5			1.3530	1.087		.200	45°
	71635			1.3820	1.120		.325	45°
31646				1.4440	1.181		.280	45°
31656				1.4445	1.140		.237	45°
31658				1.4445	1.142		.336	45°
31659				1.4445	1.150		.257	45°
	71671			1.5365	1.255		.359	45°
31674				1.5695	1.180		.316	45°
31690				1.6320	1.333		.237	45°
	71697			1.6570	1.312		.395	45°
	71701+5			1.6950	1.250		.375	45°
31707	71707			1.6945	1.375		.295	45°
31709	71709	91709		1.7220	1.358		.265	45°
31715				1.7570	1.468		.276	45°
31726				1.8170	1.540		.365	30°
31734	71734			1.8530	1.500		.273	30°
	71739			1.8800	1.563		.438	30°
31746	71746			1.9120	1.625		.281	45°
31749				1.9430	1.625		.281	45°
31756	71756			2.0010	1.712		.385	30°
31756+10				2.0110	1.712		.385	30°
31758				2.0035	1.688		.438	45°
	71765			2.0180	1.594		.281	45°
31766				2.0485	1.781		.344	30°
31768	71768			2.0680	1.688		.281	45°
31769				2.0680	1.750		.281	45°
	71770			2.0680	1.813		.188	45°
31771				2.0880	1.692		.299	45°
	71776			2.1305	1.750		.250	45°
	71777			2.1305	1.750		.219	45°
31779		91779		2.1305	1.813		.188	45°
	71783+5			2.1700	1.732		.433	45°
31787	71787			2.2550	1.875		.375	45°
	71800			1.2835	1.083		.354	45°
	71801			1.7913	1.440		.374	45°
	71802			1.5650	1.299		.335	45°

* Special ID Features

VALVE SEAT NUMERICAL LISTING BY PART NUMBER

PART NUMBER SERIES				ACTUAL	ID	ID TOP	DEPTH	SEAT
30000	70000	90000	"Killer Bee"	OD	ID	TAPER	DEPTH	ANGLE
	71803			1.5827	1.368		.272	45°
	71804			1.0984	0.906		.256	45°
	71805			1.3839	1.181		.291	45°
	71807			1.1102	0.890		.236	45°
31808	71808			1.2602	0.984		.315	45°
	71809			1.3701	1.142		.256	45°
	71810			1.6614	1.398		.315	45°
31811	71811			1.6811	1.398		.335	45°
	71812			1.1122	0.890		.236	45°
	71813			1.6201	1.398		.256	45°
	71814			1.7205	1.457		.335	45°
	71815			2.3819	2.000		.394	45°
	71816			2.0508	1.575		.364	45°
31825				1.8045	1.375	1.610*	.375	45°
31827		91827		1.8125	1.540		.365	60°
		91828		1.6875	1.410		.365	20°
31829		91829		2.0060	1.630		.280	0°
		91829+5		2.0110	1.630		.280	0°
31830				2.1400	1.812		.375	45°
	71838			1.4010	1.125		.266	45°
	71839			1.4210	1.125		.266	45°
	71840			1.5260	1.250		.250	45°
	71841			1.6090	1.313		.219	45°
31843				1.8120	1.450		.197	30°
31845				2.3810	2.030		.323	60°
	71851			1.5669	1.313		.177	45°
	71852			1.6535	1.313		.250	45°
	71853			1.5059	1.181		.157	45°
	71854			1.4803	1.181		.281	45°
31856				1.6937	1.394		.305	45°
31857				1.7035	1.394		.315	45°
	71858			1.4764	1.236		.335	45°
31859				1.6299	1.398		.197	45°
31860				1.9232	1.634		.177	45°
31862				1.7524	1.437		.157	45°
31863				1.7559	1.476		.281	45°
	71864			1.4862	1.219		.344	45°
	71866			1.4425	1.189		.217	45°
31868				1.1945	0.935		.235	45°
31870	71870			1.5670	1.250		.188	45°
31872				1.0240	0.709		.355	45°
31874				1.1020	0.787		.355	45°
31875				1.1420	0.827		.375	45°
31876				1.1810	0.866		.375	45°
31880				1.3390	1.024		.375	45°
31894				1.8900	1.476		.434	45°
31895				1.9290	1.516		.434	45°
31897				2.1320	1.690		.450	45°
31898				1.9450	1.500		.450	45°
31900				1.7570	1.375		.450	45°
	71901			1.3020	0.975		.250	45°
	71903			1.4840	1.125		.219	45°
	71904			1.5890	1.250		.250	45°
	71905			1.6090	1.250		.250	45°
	71906			1.5060	1.000		.406	45°
31907				1.7420	1.487		.268	45°
	71908			1.4630	1.220		.354	45°

* Special ID Features

VALVE SEAT NUMERICAL LISTING BY PART NUMBER

PART NUMBER SERIES				ACTUAL	ID	ID TOP	DEPTH	SEAT
30000	70000	90000	"Killer Bee"	OD	ID	TAPER	DEPTH	ANGLE
31909				1.5060	1.205		.322	45°
31910				1.8180	1.520		.300	45°
	71913			1.8917	1.575		.315	45°
		91914		1.2795	1.063		.217	45°
	71918			1.4016	1.126		.158	45°
	71924			1.6285	1.348	1.524	.365	45°
	71925			1.7330	1.455	1.620	.365	45°
	71930			1.8800	1.562	1.740	.187	45°
	71931			1.6535	1.299		.374	45°
		91933		1.8060	1.417		.292	45°
	71937			1.2047	0.945		.226	45°
31945				1.9181	1.703		.197	45°
	71946			1.6220	1.344		.197	45°
	71947		31949C	1.6930	1.437	1.625*	.250	30°
				2.2555	1.820		.375	45°
	71951			1.8180	1.520		.334	45°
	71954			1.8180	1.414		.334	45°
	71955			1.8800	1.625	1.775	.219	45°
31957	71957			2.0060	1.688	1.900*	.219	30°
		91959		2.0150	1.670		.282	0°
	71960			1.6920	1.372	1.492	.281	53°
	71961			1.8180	1.520		.177	45°
31972				1.5510	1.180	1.450	.320	45°
31979				1.6500	1.408	1.580*	.375	45°
31981				2.3500	1.970		.375	45°
31983				2.2560	1.938		.375	45°
	71988			2.0060	1.600		.375	45°
	71990			2.1310	1.810		.375	45°
31992				1.5285	1.250		.265	45°
31994				1.7648	1.511		.265	45°
	71995			2.2590	1.960		.250	45°
	71996			1.6450	1.406		.187	45°
32001				1.4571	1.260		.240	45°
	72002			1.7863	1.500		.288	45°
32003				2.1300	1.906		.177	45°
32004	72004			2.0270	1.772		.177	45°
32008				1.8179	1.500		.256	45°
	72009			1.5649	1.272		.256	45°
	72011			1.8195	1.570		.284	60°
32017	72017		22017C 22018C	2.0005	1.602		.377	45°
				2.4505	2.000		.377	45°
		92022		2.1600	1.750		.375	45°
		92026		1.8810	1.594		.375	45°
		92027		1.0722	0.864		.276	45°
		92028		1.2593	1.061		.276	45°
	72031			2.0906	1.693	1.990	.374	70°
		92032		1.3638	1.166		.276	45°
		92033		1.2063	0.989		.276	45°
32034		92034		2.0441	1.732		.406	45°
		92035		1.5953	1.181		.394	45°
	72038			1.3190	1.024		.313	45°
	72039			1.1811	1.024		.374	45°
	72040	92040		1.9685	1.693		.295	45°
32041				2.1701	1.751		.336	80°
		92042		1.2677	0.906	1.024	.248	45°
	72043			1.1280	0.906		.303	45°
	72044			2.1701	1.751		.336	80°

* Special ID Features

VALVE SEAT NUMERICAL LISTING BY PART NUMBER

PART NUMBER SERIES				ACTUAL	ID	ID TOP	DEPTH	SEAT
30000	70000	90000	"Killer Bee"	OD	ID	TAPER		ANGLE
		92047		1.1358	0.925		.217	45°
		92048		2.0709	1.752		.236	45°
		92049		1.6260	1.319		.236	45°
		92050		1.8307	1.575		.276	45°
		92051		1.4803	1.181		.260	45°
		92052		1.5953	1.319		.394	45°
	72065			1.9685	1.614		.315	45°
	72066			0.9547	0.709		.276	45°
32069				1.6500	1.340		.350	45°
32071				2.1000	1.818		.431	45°
32072				1.6000	1.300		.409	45°
		92074		1.6339	1.378		.315	45°
		92075		1.3583	1.142		.295	45°
32076	72076			1.6500	1.280	1.500*	.350	45°
32078				2.0000	1.600	1.870*	.375	45°
	72085			1.3750	1.100	1.200	.227	60°
	72086			1.2250	0.825		.350	45°
32087				2.2000	1.830	1.983	.312	45°
32088				1.6500	1.400	1.566	.375	45°
32089				1.6000	1.345	1.444	.400	45°
32090				2.0000	1.745	1.844	.400	45°
32091				1.6500	1.390	1.489	.400	45°
32093				2.2000	1.720	1.863	.312	45°
		92100		1.4650	1.181		.218	45°
		92101		1.7327	1.417		.238	45°
		92102		1.4965	1.181		.238	45°
		92103		1.7425	1.457		.250	45°
		92104		1.5161	1.260		.250	45°
		92105		1.4138	1.220		.238	45°
		92106		1.2169	0.984		.250	45°
32108				2.3120	1.937		.312	45°
32109				1.7550	1.468		.312	45°
32111				1.8180	1.438		.312	45°
32113				1.5680	1.250		.343	45°
32115				1.9420	1.563		.375	45°
32118				2.3180	2.000		.375	45°
32119				1.8800	1.594		.375	45°
		92124		1.6023	1.398		.315	45°
		92125		1.3268	1.142		.295	45°
	72126			1.5400	1.240		.275	45°
	72128			1.3450	1.083		.236	45°
	72129			1.6470	1.300		.325	45°
			32130C	1.0490	0.825		.298	45°
32131				0.9500	0.765		.250	45°
32132				1.3450	1.050		.290	45°
32133				1.5400	1.300		.315	45°
32138				1.6500	1.340		.425	45°
32139		92139		2.1300	1.812	2.030	.437	45°
	72148			1.6090	1.313		.414	45°
		92156		2.2560	1.960		.250	60°
32163				2.0000	1.580		.375	45°
	72171			2.1360	1.652	1.978*	.310	52°
	72172			2.1360	1.705	1.978*	.295	60°
32173				1.6370	1.437		.350	45°
32174				1.4830	1.260		.350	45°
	72177			1.3190	1.063		.250	45°
	72178			1.6600	1.412		.256	45°

* Special ID Features

VALVE SEAT NUMERICAL LISTING BY PART NUMBER

30000	PART NUMBER SERIES			ACTUAL OD	ID	ID TOP TAPER	DEPTH	SEAT ANGLE
	70000	90000	"Killer Bee"					
32183			32182C	1.1980	0.960		.295	45°
				1.3920	1.141		.318	45°
32187		92186		2.1250	1.800		.437	45°
				1.6500	1.367		.380	45°
32188				2.0485	1.765	1.809	.250	45°
32189	72189			1.6050	1.310	1.428	.250	45°
			22193C	2.2500	1.850		.320	45°
			22194C	1.6700	1.350		.375	45°
32196	72195			1.2992	1.063		.217	45°
				1.9570	1.665		.280	45°
32197				1.4100	1.142		.275	45°
32198				1.1700	0.906		.275	45°
32208			22199C	1.7570	1.380	1.717*	.400	58°
				2.0600	1.562		.450	45°
32209				2.1640	1.750		.450	45°
32212			32210C	1.1450	0.835		.295	45°
				2.0680	1.770	2.016*	.250	45°
32213				1.6300	1.323	1.580*	.240	45°
	72215			1.7374	1.417		.354	45°
	72216			2.1340	1.693		.394	45°
	72217			1.8540	1.499	1.619*	.273	60°
	72218			1.7210	1.360	1.565*	.264	45°
	72221	92222		1.8976	1.457		.284	45°
	72223			1.3248	1.157		.260	45°
	72224			2.0675	1.748	2.026*	.392	45°
	72226			1.6300	1.321	1.549*	.393	60°
			22228C	1.2402	1.016		.276	45°
				2.3800	1.904		.375	45°
	72232			1.8545	1.576	1.788*	.230	45°
32237			32233C	1.7500	1.375	*	.550	-
				2.0000	1.665	1.837	.375	60°
32238				1.8134	1.567	1.714*	.282	44°
32239				1.4665	1.181	1.350*	.282	44°
32240				1.7421	1.480	1.642*	.282	44°
	72241			1.9620	1.597	1.597*	.365	R.178
	72242			1.7320	1.457	1.457*	.365	R.212
	72246			2.2590	1.960	2.135*	.250	45°
	72250			1.1614	0.906		.275	45°
			22251C	2.5000	2.040		.375	45°
			22252C	1.9600	1.625		.375	45°
		92255		1.1921	0.787		.315	45°
		92256		1.3386	0.945		.335	45°
		92257		1.4429	1.024		.335	45°
		92258		1.5051	1.102		.335	45°
		92259		1.6000	1.181		.315	45°
		92260		1.7362	1.280		.315	45°
		92261		1.8898	1.417		.335	45°
		92262		1.2402	0.965		.315	45°
		92263		1.5157	1.240		.295	45°
32265			22264C	1.6900	1.370		.500	R.125
				1.3615	1.142		.220	60°
	72266			1.1640	0.925		.220	45°
	72269			2.0669	1.750		.413	45°
	72270			1.6260	1.319		.413	45°
	72271			1.6142	1.260		.413	45°
32272				2.3120	1.937		.220	45°
32273				1.7550	1.468		.220	45°

* Special ID Features

VALVE SEAT NUMERICAL LISTING BY PART NUMBER

PART NUMBER SERIES				ACTUAL	ID	ID TOP	DEPTH	SEAT
30000	70000	90000	"Killer Bee"	OD	ID	TAPER	DEPTH	ANGLE
	72276			2.1940	1.812		.375	45°
	72278			1.2531	1.079		.335	45°
	72279	92279		1.1886	0.949		.319	45°
32280				1.5000	1.273		.180	60°
	72281			1.2840	1.078		.160	45°
		92282		1.9685	1.500		.335	45°
		92283		1.0236	0.709		.276	45°
	72286			1.3860	1.181		.260	45°
32287				1.6344	1.375		.256	45°
		92289		1.2598	0.866		.335	45°
		92290		1.1024	0.709		.236	45°
	72298			2.0060	1.750	1.880	.219	45°
	72301			1.2728	1.079		.335	45°
	72302			1.2925	1.079		.335	45°
		92303		1.1831	0.933		.197	45°
	72305			1.6289	1.359	1.500*	.250	30°
	72306			1.8203	1.570	1.660*	.282	30°
	72307			1.8785	1.565	1.725*	.438	30°
32324				1.9510	1.691	1.860*	.262	R.187
32327				1.7856	1.514	1.680*	.275	R.159
	72328			2.3665	2.008		.350	45°
	72329			2.3744	2.008		.358	45°
	72330			2.3823	2.008		.366	45°
	72331			1.9728	1.693		.394	45°
	72332			1.9807	1.693		.402	45°
	72333			1.9886	1.693		.409	45°
	72334	92334		0.9449	0.709		.315	45°
	72335	92335		0.9843	0.748		.315	45°
	72336			1.0236	0.787		.315	45°
	72337			1.0630	0.827		.394	45°
	72338			1.1417	0.709		.394	45°
	72339			1.1339	0.945		.339	45°
	72340			1.2913	1.122		.346	45°
	72341			1.4764	1.228		.274	45°
	72342			1.7374	1.398		.274	45°
	72343			1.6535	1.365	1.487	.250	40°
	72344			2.0060	1.688		.188	45°
32346				1.4852	1.238	1.380	.315	45°
	72347			2.1600	1.750		.350	45°
32348				1.5040	1.215	1.405	.255	45°
32349				2.1925	1.875		.375	45°
32350				1.7550	1.437		.375	45°
32351				1.5110	1.220	1.405	.275	45°
32354				2.1700	1.800		.375	45°
32356				1.7200	1.280		.350	45°
32357				2.2500	1.947	2.120	.312	45°
32358				2.0000	1.593	1.790	.375	45°
	72359			1.8120	1.540	1.650*	.365	30°
	72360			2.3810	1.927	2.140*	.319	30°
	72361			2.0485	1.771	1.928*	.339	30°
		92362		2.0030	1.690	*	.280	30°
	72363			2.0080	1.700	*	.280	30°
	72364			1.8535	1.500	*	.272	30°
			22365C	2.4600	2.040		.375	45°
			32366C	1.9600	1.655		.375	45°
		92369		1.2205	0.709		.295	45°
32370				2.4430	2.125		.375	45°

* Special ID Features

VALVE SEAT NUMERICAL LISTING BY PART NUMBER

PART NUMBER SERIES				ACTUAL	ID	ID TOP	DEPTH	SEAT
30000	70000	90000	"Killer Bee"	OD	ID	TAPER	DEPTH	ANGLE
	72371			1.4110	1.094		.219	45°
	72372			1.1925	0.875		.219	45°
		92373		1.8500	1.500		.281	60°
		92373+5		1.8550	1.500		.281	60°
		92373+10		1.8600	1.500		.281	60°
		92373+20		1.8700	1.500		.281	60°
	72374			1.5555	1.281	1.398*	.236	30°
	72375			1.5555	1.300	1.385*	.189	45°
	72376			1.8545	1.570	1.711*	.249	45°
32378				1.9430	1.688		.281	45°
32379				1.8180	1.563		.280	45°
	72381			1.2598	0.945		.260	45°
			17563C	2.4074	1.956	2.287*	.284	30°
			17846C	2.0906	1.693	1.990	.303	70°
			17904C	2.4094	1.890		.354	45°
	72382			2.0933	1.693		.354	45°
		92383		2.0835	1.732		.406	45°
		92384		1.6346	1.319		.394	45°
	72389			1.6980	1.419	1.598*	.264	45°
	72390			1.4618	1.183	1.362*	.264	45°
		92391		1.8898	1.417	1.668*	.360	35°
	72392			1.8100	1.535	1.731*	.364	30°
	72393			1.5980	1.438		.188	45°
	72394			1.6100	1.438		.188	45°
	72395			1.7800	1.620		.188	45°
32396				1.9550	1.695		.270	45°
32397				2.0500	1.750		.270	45°
		92399		2.1140	1.693		.394	45°
		92400		2.0905	1.693	1.929	.327	20°
	72401			2.0006	1.730	1.906	.264	49°
		92402		2.1516	1.720		.394	45°
		92404		1.0630	0.787		.315	45°
			72405C	1.5020	1.219	1.408*	.255	33°
32408				2.0060	1.688	1.949*	.282	35°
32409				1.5680	1.250	1.450*	.281	35°
	72416			1.7725	1.433		.270	45°
			72419C	1.1990	0.960	1.076	.322	45°
	72420			1.4724	1.250	1.372	.310	45°
	72424			2.0695	1.750		.420	45°
32425				1.6310	1.187		.450	45°
32426				1.8190	1.375		.450	45°
32427				1.8810	1.437		.450	45°
32428				2.0680	1.687		.450	45°
32429				2.1940	1.800		.450	45°
32430				2.2560	1.870		.450	45°
	72431			2.1856	1.820	*	.338	36.8°
			72432C	1.6020	1.322	*	.276	36.3°
		92434		1.5803	1.299		.315	45°
		92435		1.6591	1.299		.315	45°
32437				1.4960	1.142		.434	45°
		97999		2.0945	1.693		.276	45°
	78000			1.2260	0.945		.204	45°
39006	79006	99006		1.1024	0.866		.394	45°
39007	79007	99007		1.1220	0.866		.394	45°
39008	79008	99008		1.1417	0.906		.394	45°
39009	79009	99009		1.1614	0.906		.394	45°
39010	79010	99010		1.1811	0.906		.394	45°

* Special ID Features

VALVE SEAT NUMERICAL LISTING BY PART NUMBER

PART NUMBER SERIES				ACTUAL		ID TOP		SEAT
30000	70000	90000	"Killer Bee"	OD	ID	TAPER	DEPTH	ANGLE
39011	79011	99011		1.1811	0.787		.394	45°
39012	79012	99012		1.2008	0.906		.394	45°
39013	79013	99013		1.2205	0.945		.394	45°
39014	79014	99014		1.2205	0.827		.394	45°
39015	79015	99015		1.2402	0.945		.394	45°
39016	79016	99016		1.2598	0.984		.394	45°
39017	79017	99017		1.2598	0.866		.394	45°
39018	79018	99018		1.2795	0.984		.394	45°
39019	79019	99019		1.2992	1.023		.394	45°
39020	79020	99020		1.2992	0.906		.394	45°
39021	79021	99021		1.3189	1.023		.394	45°
39023	79023	99023		1.3386	0.945		.394	45°
39024	79024	99024		1.3583	1.063		.394	45°
39025	79025	99025		1.3780	1.102		.394	45°
39026	79026	99026		1.3780	0.984		.394	45°
39027	79027			1.3976	1.102		.394	45°
39028	79028	99028		1.4173	1.142		.394	45°
39029	79029	99029		1.4173	1.024		.394	45°
39030	79030	99030		1.4370	1.141		.394	45°
39031	79031	99031		1.4567	1.181		.394	45°
39033	79033			1.4764	1.181		.394	45°
39035	79035	99035		1.4961	1.102		.394	45°
39036	79036			1.5157	1.220		.394	45°
39037	79037	99037		1.5354	1.260		.394	45°
39038	79038			1.5354	1.141		.394	45°
39039	79039			1.5551	1.260		.394	45°
39040	79040			1.5748	1.260		.394	45°
39041	79041	99041		1.5748	1.141		.394	45°
39042	79042			1.5945	1.260		.394	45°
39043	79043	99043		1.6142	1.299		.394	45°
39044	79044			1.6142	1.181		.394	45°
39045	79045	99045		1.6339	1.299		.394	45°
39046	79046			1.6535	1.338		.394	45°
39047	79047			1.6535	1.220		.394	45°
39048	79048			1.6732	1.338		.394	45°
39049	79049			1.6929	1.378		.394	45°
39050	79050			1.6929	1.260		.394	45°
39051	79051			1.7126	1.378		.394	45°
39052				1.7323	1.417		.394	45°
39053	79053	99053		1.7323	1.299		.394	45°
39055	79055			1.7520	1.417		.433	45°
39056	79056			1.7520	1.181		.394	45°
39057	79057	99057		1.7717	1.457		.472	45°
39058	79058	99058		1.7717	1.339		.472	45°
39059	79059			1.7913	1.457		.472	45°
39060	79060			1.8110	1.496		.472	45°
39061	79061			1.8110	1.339		.472	45°
39062	79062			1.8307	1.496		.472	45°
39063				1.8504	1.535		.472	45°
39065	79065	99065		1.8504	1.417		.472	45°
39066	79066			1.8701	1.535		.472	45°
39067	79067			1.8898	1.575		.472	45°
39068	79068			1.8898	1.496		.433	45°
39069	79069			1.8898	1.457		.472	45°
39071	79071			1.7520	1.417		.394	45°
	79072			1.2992	0.984		.315	45°
	79073			1.3386	1.102		.315	45°

* Special ID Features

VALVE SEAT NUMERICAL LISTING BY PART NUMBER

PART NUMBER SERIES				ACTUAL		ID TOP		SEAT
30000	70000	90000	"Killer Bee"	OD	ID	TAPER	DEPTH	ANGLE
	79074			1.3780	1.102		.315	45°
	79075			1.4173	1.181		.315	45°
	79076			1.4961	1.181		.315	45°
	79077			1.5354	1.181		.315	45°
	79078			1.5748	1.299		.315	45°
	79079			1.6142	1.260		.315	45°
	79080			1.6535	1.299		.315	45°
	79081			1.6929	1.378		.315	45°
	79082			1.7323	1.417		.315	45°
	79083			1.7717	1.417		.315	45°
	79084			1.8110	1.496		.315	45°

* Special ID Features

VALVE SEAT PROGRESSIVE LISTING BY OUTSIDE DIAMETER

ACTUAL OD	ID	ID TOP TAPER	DEPTH	SEAT ANGLE	PART NUMBER SERIES			
					30000	70000	90000	"Killer Bee"
0.9252	0.709		.236	45°		71357		
0.9449	0.709		.256	45°		71167		
0.9449	0.709		.315	45°		72334	92334	
0.9500	0.765		.250	45°	32131			
0.9547	0.709		.276	45°		72066		
0.9843	0.748		.315	45°		72335	92335	
0.9843	0.787		.276	45°		71446		
0.9882	0.787		.236	45°		71346		
0.9890	0.787		.236	45°	31002	71002		
0.9902	0.787		.236	45°		71349		
1.0045	0.750		.188	45°		71600		
1.0236	0.709		.276	45°			92283	
1.0236	0.787		.315	45°		72336		
1.0240	0.709		.355	45°	31872			
1.0335	0.827		.177	45°		71398		
1.0472	0.827		.236	45°		71382		
1.0490	0.825		.298	45°				32130C
1.0512	0.787		.224	45°	31003	71003		
1.0551	0.827		.244	45°		71395		
1.0559	0.807		.224	45°		71350		
1.0630	0.787		.315	45°			92404	
1.0630	0.827		.394	45°		72337		
1.0681	0.871		.254	45°	31096			
1.0689	0.787		.236	45°		71383		
1.0690	0.781		.250	45°		71142		
1.0690	0.790		.260	45°	31047	71047		
1.0722	0.864		.276	45°			92027	
1.0898	0.874		.250	45°		71429		
1.0984	0.906		.256	45°		71804		
1.1020	0.787		.355	45°	31874			
1.1024	0.709		.236	45°			92290	
1.1024	0.787		.315	45°		71168		
1.1024	0.807		.256	45°		71428		
1.1024	0.866		.394	45°	39006	79006	99006	
1.1083	0.866		.256	45°		71396		
1.1102	0.890		.236	45°		71807		
1.1122	0.890		.236	45°		71812		
1.1220	0.866		.394	45°	39007	79007	99007	
1.1280	0.906		.303	45°		72043		
1.1299	0.871		.191	45°	31097			
1.1300	0.875		.219	45°	30754			
1.1310	0.750		.250	45°	31143	71143		
1.1320	0.825		.285	45°	31048	71048		
1.1339	0.945		.339	45°		72339		
1.1358	0.925		.217	45°			92047	
1.1417	0.709		.394	45°		72338		
1.1417	0.827		.335	45°		71169		
1.1417	0.906		.394	45°	39008	79008	99008	
1.1420	0.827		.375	45°	31875			
1.1450	0.835		.295	45°				32210C
1.1496	0.906		.256	45°		71410	91410	
1.1516	0.874		.250	45°		71431		
1.1614	0.906		.275	45°		72250		
1.1614	0.906		.394	45°	39009	79009	99009	
1.1640	0.925		.220	45°		72266		
1.1661	0.809		.280	45°		71358		
1.1700	0.906		.275	45°	32198			

* Special ID Features

VALVE SEAT PROGRESSIVE LISTING BY OUTSIDE DIAMETER

ACTUAL OD	ID	ID TOP TAPER	DEPTH	SEAT ANGLE	PART NUMBER SERIES			
					30000	70000	90000	"Killer Bee"
1.1732	0.945		.236	45°		71444		
1.1810	0.866		.375	45°	31876			
1.1811	0.787		.394	45°	39011	79011	99011	
1.1811	0.866		.335	45°	31170	71170		
1.1811	0.906		.394	45°	39010	79010	99010	
1.1811	0.945		.335	45°		71411		
1.1811	1.024		.374	45°		72039		
1.1819	0.925		.244	45°	31049	71049		
1.1831	0.933		.197	45°			92303	
1.1850	0.984		.248	45°		71345		
1.1858	0.984		.248	45°		71004		
1.1870	0.945		.354	45°		71436		
1.1870	0.984		.200	45°		71445		
1.1870	0.984		.248	45°	31005	71005		
1.1886	0.949		.319	45°		72279	92279	
1.1921	0.875		.250	45°		71352		
1.1921	0.787		.315	45°			92255	
1.1925	0.875		.219	45°		72372		
1.1933	0.871		.254	45°	31098			
1.1933	0.929		.256	45°		71435		
1.1933	0.933		.254	45°	31099			
1.1940	0.875		.250	45°		71144		
1.1940	0.905		.257	45°	31146	71146		
1.1940	0.938		.250	45°	31145	71145		
1.1945	0.935		.235	45°	31868			
1.1980	0.960		.295	45°				32182C
1.1990	0.960	1.076	.322	45°				72419C
1.2008	0.906		.394	45°	39012	79012	99012	
1.2008	0.984		.256	45°	31051	71051		
1.2047	0.945		.226	45°		71937		
1.2063	0.989		.276	45°			92033	
1.2169	0.984		.250	45°			92106	
1.2205	0.709		.295	45°			92369	
1.2205	0.827		.394	45°	39014	79014	99014	
1.2205	0.906		.335	45°	31171	71171		
1.2205	0.945		.394	45°	39013	79013	99013	
1.2205	0.984		.237	45°		71448		
1.2250	0.825		.350	45°		72086		
1.2252	0.910		.283	45°		71354		
1.2260	0.945		.204	45°		78000		
1.2303	0.984		.315	45°		71414		
1.2402	0.965		.315	45°			92262	
1.2402	0.945		.394	45°	39015	79015	99015	
1.2402	1.016		.276	45°		72226		
1.2407	0.941		.335	45°		71434		
1.2441	1.024		.236	45°		71384		
1.2480	1.024		.256	45°		71409		
1.2531	1.079		.335	45°		72278		
1.2550	1.000		.250	45°	30764	70764		
1.2550	1.028		.227	45°	31043	71043		
1.2550	1.055		.250	45°	31052			
1.2551	1.000		.250	45°		71359		
1.2559	0.933		.254	45°	31105	71105		
1.2559	0.996		.254	45°	31100			
1.2560	0.875		.250	45°	31151	71151		
1.2560	0.906		.313	45°	31149	71149		
1.2560	0.910	1.070	.281	45°	31333			

* Special ID Features

VALVE SEAT PROGRESSIVE LISTING BY OUTSIDE DIAMETER

ACTUAL OD	ID	ID TOP TAPER	DEPTH	SEAT ANGLE	PART NUMBER SERIES			
					30000	70000	90000	"Killer Bee"
1.2560	0.938		.188	45°	31152	71152		
1.2560	1.000		.219	45°	31147	71147		
1.2560	1.000		.250	45°		71150	91150	
1.2560	1.000		.313	45°		71148		
1.2570	0.905	1.000	.230	45°	30230			
1.2570	0.910		.285	45°	31054	71054		
1.2570	0.930		.325	45°	31612			
1.2570	0.970		.270	45°	31613			
1.2593	1.061		.276	45°			92028	
1.2598	0.866		.335	45°			92289	
1.2598	0.866		.394	45°	39017	79017	99017	
1.2598	0.945		.260	45°		72381		
1.2598	0.945		.335	45°		71172		
1.2598	0.945		.354	45°		71311	91311	
1.2598	0.984		.394	45°	39016	79016	99016	
1.2602	0.984		.315	45°	31808	71808		
1.2620	0.975		.250	30°		71621		
1.2670	0.982	1.065	.320	45°	31313			
1.2677	0.906	1.024	.248	45°			92042	
1.2724	1.024		.236	45°		71347		
1.2728	1.079		.335	45°		72301		
1.2736	0.906	1.024	.248	45°			91450	
1.2795	0.984		.394	45°	39018	79018	99018	
1.2795	1.063		.217	45°			91914	
1.2820	0.975		.250	45°		71502		
1.2827	1.063		.236	45°		71403		
1.2835	1.083		.354	45°		71800		
1.2840	1.078		.160	45°		72281		
1.2854	0.984		.236	45°		71360		
1.2854	1.004		.315	45°	31006	71006		
1.2854	1.024		.335	45°	31007	71007		
1.2913	1.122		.346	45°		72340		
1.2925	1.079		.335	45°		72302		
1.2992	0.905		.315	45°		71425		
1.2992	0.906		.394	45°	39020	79020	99020	
1.2992	0.984		.315	45°		79072		
1.2992	0.984		.335	45°	31173	71173		
1.2992	1.023		.394	45°	39019	79019	99019	
1.2992	1.024		.256	45°		71348	91348	
1.2992	1.063		.217	45°		72195		
1.3020	0.975		.250	45°		71901		
1.3050	1.048		.227	45°	30739			
1.3051	1.102		.276	45°		71008	91008	
1.3071	1.083		.276	45°		71123		
1.3170	1.046		.219	45°	30735			
1.3170	1.046		.250	45°	30736			
1.3170	1.046		.313	45°	30737			
1.3170	1.063		.219	45°	31289	71289		
1.3175	1.000		.250	45°	31056			
1.3181	1.059		.254	45°	31101	71101		
1.3189	1.023		.394	45°	39021	79021	99021	
1.3189	1.063		.354	45°	31293			
1.3190	0.975		.280	45°	31058			
1.3190	0.977		.300	45°	31340			
1.3190	1.000		.250	45°		71154		
1.3190	1.000		.313	45°	31155	71155		
1.3190	1.024		.313	45°		72038		

* Special ID Features

VALVE SEAT PROGRESSIVE LISTING BY OUTSIDE DIAMETER

ACTUAL OD	ID	ID TOP TAPER	DEPTH	SEAT ANGLE	PART NUMBER SERIES			
					30000	70000	90000	"Killer Bee"
1.3190	1.042		.238	45°	30779	70779		
1.3190	1.045		.316	45°		70563		
1.3190	1.062		.188	45°	30775			
1.3190	1.063		.250	45°		72177		
1.3190	1.063		.313	45°	31153	71153		
1.3190	1.085		.305	45°	30562			
1.3190	1.123		.300	45°	31320	71320		
1.3195	1.060		.275	45°	31628	71628		
1.3228	1.082		.287	45°		71397		
1.3248	1.157		.260	45°			92222	
1.3268	1.063		.315	45°	31009	71009		
1.3268	1.126		.250	45°	31010	71010	91010	
1.3268	1.142		.295	45°			92125	
1.3307	1.126		.250	45°		71438		
1.3386	0.945		.335	45°			92256	
1.3386	0.945		.394	45°	39023	79023	99023	
1.3386	1.024		.335	45°	31174	71174		
1.3386	1.063		.394	45°	31273	71273	91273	
1.3386	1.102		.315	45°		79073		
1.3387	1.102		.177	45°		71306		
1.3390	1.024		.375	45°	31880			
1.3425	1.083		.236	45°		71385		
1.3433	1.025		.299	45°		71361		
1.3445	1.102		.236	45°			91449	
1.3450	1.050		.290	45°	32132			
1.3450	1.083		.236	45°		72128		
1.3484	1.063		.315	45°	31060	71060		
1.3484	1.126		.250	45°		71011		
1.3504	1.063		.315	45°		71356		
1.3530	1.087		.200	45°		71633+5		
1.3583	1.063		.394	45°	39024	79024	99024	
1.3583	1.142		.295	45°			92075	
1.3615	1.142		.220	60°	32265			
1.3634	0.984		.394	45°	31035	71035		
1.3638	1.166		.276	45°			92032	
1.3661	1.114		.295	45°	31061	71061		
1.3701	1.142		.256	45°		71809		
1.3701	1.142		.283	45°		71362		
1.3750	1.100	1.200	.227	60°		72085		
1.3780	0.984		.394	45°	39026	79026	99026	
1.3780	1.024		.354	45°		71175		
1.3780	1.102		.197	45°		71408		
1.3780	1.102		.315	45°		79074		
1.3780	1.102		.394	45°	39025	79025	99025	
1.3800	1.062		.219	45°	31125	71125		
1.3800	1.063		.188	45°	30786	70786		
1.3800	1.063		.250	45°	30788	70788		
1.3800	1.063		.313	45°	30787	70787		
1.3800	1.125		.188	45°	30790	70790		
1.3800	1.125		.219	45°	30558	70558		
1.3800	1.125		.250	45°	30791	70791		
1.3800	1.125		.375	45°		70792		
1.3803	1.093		.250	45°		71363		
1.3807	1.059		.254	45°	31102			
1.3807	1.121		.254	45°	31103			
1.3810	0.938		.313	45°		71156		
1.3810	1.125		.266	45°	31157	71157		

* Special ID Features

VALVE SEAT PROGRESSIVE LISTING BY OUTSIDE DIAMETER

ACTUAL OD	ID	ID TOP TAPER	DEPTH	SEAT ANGLE	PART NUMBER SERIES			
					30000	70000	90000	"Killer Bee"
1.3820	1.000		.280	45°	31064			
1.3820	1.000		.410	45°	31063			
1.3820	1.100		.300	45°	31139	71139		
1.3820	1.102	1.160	.260	45°	30238	70238		
1.3820	1.120		.325	45°		71635		
1.3839	1.181		.291	45°		71805		
1.3860	1.181		.260	45°		72286		
1.3878	1.102		.315	45°	31065	71065		
1.3920	1.141		.318	45°	32183			
1.3976	1.102		.394	45°	39027	79027		
1.3976	1.142		.394	45°	31274	71274		
1.3976	1.161		.374	45°	31294			
1.4010	1.125		.266	45°		71838		
1.4016	1.126		.158	45°		71918		
1.4016	1.142		.315	45°	31012	71012		
1.4055	1.181		.339	45°		71423		
1.4100	1.142		.275	45°	32197			
1.4110	1.094		.219	45°		72371		
1.4114	1.181		.244	45°		71399		
1.4138	1.220		.238	45°			92105	
1.4173	1.024		.394	45°	39029	79029	99029	
1.4173	1.063		.354	45°		71176		
1.4173	1.142		.394	45°	39028	79028	99028	
1.4173	1.181		.315	45°		79075		
1.4210	1.125		.266	45°		71839		
1.4220	1.152		.315	45°	31066	71066		
1.4236	1.152		.250	45°		71412		
1.4252	1.220		.295	45°		71121		
1.4272	1.142		.315	45°		71420		
1.4370	1.141		.394	45°	39030	79030	99030	
1.4405	1.186		.313	45°	31111	71111		
1.4421	1.125		.250	45°		71380		
1.4421	1.125		.354	45°		71364		
1.4421	1.126		.315	45°	31013	71013		
1.4421	1.188		.250	45°	31402	71402		
1.4425	1.125		.250	45°	30802	70802		
1.4425	1.125		.313	45°	30803	70803		
1.4425	1.126		.188	45°	31225	71225		
1.4425	1.126		.219	45°	30801	70801		
1.4425	1.188		.219	45°	31030	71030		
1.4425	1.189		.217	45°		71866		
1.4425	1.219		.219	45°	31031	71031		
1.4429	1.130		.315	45°		71407		
1.4429	1.024		.335	45°			92257	
1.4433	1.059		.254	45°	31107			
1.4440	1.100		.315	45°	31329			
1.4440	1.105		.322	45°	30806			
1.4440	1.135	1.250	.316	45°	30809			
1.4440	1.181		.280	45°	31646			
1.4440	1.188		.219	45°		71159		
1.4440	1.188		.250	45°	31161	71161		
1.4440	1.200		.297	45°	30818			
1.4440	1.230		.250	45°	31067			
1.4440	1.250		.219	45°	30556	70556		
1.4440	1.250		.313	45°	31160	71160		
1.4445	1.140		.237	45°	31656			
1.4445	1.142		.336	45°	31658			

* Special ID Features

VALVE SEAT PROGRESSIVE LISTING BY OUTSIDE DIAMETER

ACTUAL OD	ID	ID TOP TAPER	DEPTH	SEAT ANGLE	PART NUMBER SERIES			
					30000	70000	90000	"Killer Bee"
1.4445	1.150		.257	45°	31659			
1.4449	1.142		.315	45°		71439		
1.4449	1.220		.295	45°		71440		
1.4567	1.102		.354	45°	31068	71068		
1.4567	1.181		.315	45°	31069	71069		
1.4567	1.181		.394	45°	39031	79031	99031	
1.4567	1.220		.394	45°	31275			
1.4571	1.260		.240	45°	32001			
1.4577	1.098		.352	45°	31113			
1.4618	1.183	1.362*	.264	45°		72390		
1.4630	1.220		.354	45°		71908		
1.4646	1.181		.276	45°	31070	71070		
1.4650	1.181		.218	45°			92100	
1.4665	1.181	1.350*	.282	44°	32239			
1.4685	1.142		.315	45°		71365		
1.4724	1.250	1.372	.310	45°		72420		
1.4750	1.240		.227	0°	31044	71044		
1.4764	1.181		.394	45°	39033	79033		
1.4764	1.220		.335	45°	31071			
1.4764	1.228		.274	45°		72341		
1.4764	1.236		.335	45°		71858		
1.4764	1.240		.335	45°		71386		
1.4777	1.213		.154	45°		71305		
1.4791	1.187		.313	45°		71353		
1.4803	1.181		.260	45°			92051	
1.4803	1.181		.281	45°		71854		
1.4803	1.200		.276	45°		71400		
1.4803	1.287		.283	45°		71379		
1.4823	1.220		.276	45°	31014			
1.4830	1.260		.350	45°	32174			
1.4840	1.125		.219	45°		71903		
1.4843	1.220		.315	45°	31015	71015		
1.4850	1.260		.237	45°	30738			
1.4852	1.238	1.380	.315	45°	32346			
1.4862	1.219		.344	45°		71864		
1.4862	1.220		.335	45°		71387		
1.4960	1.142		.434	45°	32437			
1.4961	1.102		.394	45°	39035	79035	99035	
1.4961	1.142		.354	45°		71178		
1.4961	1.181		.276	45°	31038	71038		
1.4961	1.181		.315	45°		79076		
1.4961	1.220		.394	45°	31276	71276	91276	
1.4965	1.181		.238	45°			92102	
1.5000	1.188		.250	45°	31198			
1.5000	1.273		.180	60°	32280			
1.5008	1.148		.283	45°		71366		
1.5020	1.219	1.408*	.255	33°				72405C
1.5040	1.215	1.405	.255	45°	32348			
1.5043	1.188		.313	45°		71342		
1.5043	1.250		.281	45°		71343		
1.5045	1.188		.313	45°	31032			
1.5050	1.100	1.225	.316	45°	30045			
1.5050	1.125		.188	45°	30706	70706		
1.5050	1.125		.219	45°	30707	70707		
1.5050	1.125		.250	45°	30708			
1.5050	1.125		.313	45°	30709	70709		
1.5050	1.140	1.250	.325	45°	30105	70105		

* Special ID Features

VALVE SEAT PROGRESSIVE LISTING BY OUTSIDE DIAMETER

ACTUAL OD	ID	ID TOP TAPER	DEPTH	SEAT ANGLE	PART NUMBER SERIES			
					30000	70000	90000	"Killer Bee"
1.5050	1.188		.218	45°	30823			
1.5050	1.188		.250	45°	30822	70822		
1.5050	1.215	1.344	.219	45°	30705	70705		
1.5050	1.215		.250	45°	30722	70722		
1.5050	1.215	1.275	.280	45°	30015			
1.5050	1.215		.305	45°	30721			
1.5050	1.215		.310	45°	30716			
1.5050	1.215		.318	45°		70717		
1.5050	1.250		.188	45°		70710		
1.5050	1.250		.219	45°	30711	70711		
1.5050	1.250	1.390	.240	45°	30024			
1.5050	1.250		.250	45°	30712	70712		
1.5050	1.250		.313	45°	30714	70714		
1.5050	1.250		.375	45°	30715			
1.5051	1.122		.343	45°		71367		
1.5051	1.220		.315	45°	31073	71073		
1.5051	1.102		.335	45°			92258	
1.5059	1.181		.157	45°		71853		
1.5059	1.183		.254	45°	31108			
1.5059	1.246		.254	45°	31109	71109		
1.5059	1.280		.295	45°		71419		
1.5060	1.000		.406	45°		71906		
1.5060	1.180	1.280	.214	45°		71207		
1.5060	1.180	1.345	.307	45°	31258	71258		
1.5060	1.188		.313	45°	31162	71162		
1.5060	1.195		.315	45°	31326			
1.5060	1.195		.360	45°	31501			
1.5060	1.205		.322	45°	31909			
1.5060	1.210		.345	45°	31214			
1.5060	1.230		.278	45°	31244			
1.5070	1.100		.315	45°	31074			
1.5070	1.180	1.318	.305	45°	30031			
1.5070	1.210	1.276	.345	45°	31291			
1.5110	1.220	1.405	.275	45°	32351			
1.5157	1.220		.335	45°		71388		
1.5157	1.220		.343	45°		71368		
1.5157	1.220		.394	45°	39036	79036		
1.5157	1.240		.295	45°			92263	
1.5161	1.260		.250	45°			92104	
1.5209	1.220		.285	45°		71432		
1.5248	1.183		.394	45°		71036		
1.5256	1.220		.335	45°		71389		
1.5260	1.250		.250	45°		71840		
1.5285	1.250		.265	45°	31992			
1.5335	1.221		.335	45°	31016	71016		
1.5354	1.141		.394	45°	39038	79038		
1.5354	1.181		.276	45°		71369		
1.5354	1.181		.315	45°		79077		
1.5354	1.181		.354	45°		71179		
1.5354	1.220		.335	45°		71180		
1.5354	1.260		.394	45°	39037	79037	99037	
1.5354	1.299		.315	45°		71370		
1.5365	1.255		.359	45°		71671		
1.5400	1.240		.275	45°		72126		
1.5400	1.300		.315	45°	32133			
1.5410	1.327		.256	45°		71416		
1.5413	1.366		.232	45°		71426		

* Special ID Features

VALVE SEAT PROGRESSIVE LISTING BY OUTSIDE DIAMETER

ACTUAL OD	ID	ID TOP TAPER	DEPTH	SEAT ANGLE	PART NUMBER SERIES			
					30000	70000	90000	"Killer Bee"
1.5472	1.260		.315	45°	31075	71075		
1.5510	1.180	1.450	.320	45°	31972			
1.5551	1.260		.394	45°	39039	79039		
1.5551	1.299		.335	45°	31076	71076		
1.5555	1.281	1.398*	.236	30°		72374		
1.5555	1.300	1.385*	.189	45°		72375		
1.5591	1.319		.374	45°	31295			
1.5630	1.299		.339	45°		71422		
1.5630	1.299		.354	45°		71442		
1.5649	1.272		.256	45°		72009		
1.5650	1.299		.335	45°		71802		
1.5657	1.186		.376	45°	31112	71112		
1.5669	1.250		.313	45°		71344		
1.5669	1.313		.177	45°		71851		
1.5670	1.250		.188	45°	31870	71870		
1.5670	1.344		.219	45°	31033			
1.5673	1.250		.253	45°	31077			
1.5680	1.188		.313	45°	30839	70839		
1.5680	1.250		.219	45°	30640	70640		
1.5680	1.250		.250	45°	30645	70645		
1.5680	1.250		.281	45°	30740	70740		
1.5680	1.250	1.450*	.281	35°	32409			
1.5680	1.250		.313	45°	30647	70647		
1.5680	1.250		.343	45°	32113			
1.5680	1.312	1.390	.219	45°	30541	70541		
1.5680	1.312		.219	45°	30643	70643	90643	30643C
1.5680	1.312	1.390	.250	45°	30503	70503		
1.5680	1.312		.250	45°	30644	70644		
1.5680	1.312		.313	45°	30731			
1.5680	1.313		.188	45°	30840	70840		
1.5680	1.313		.219	30°		70838		
1.5680	1.313		.280	45°		71267		
1.5680	1.375		.218	45°	30841			
1.5681	1.183		.254	45°	31104			
1.5685	1.255	1.372	.319	45°	31199	71199		
1.5690	1.125		.313	45°		71163		
1.5690	1.180		.305	45°	31079			
1.5690	1.230		.310	45°	31078			
1.5695	1.180		.316	45°	31674			
1.5695	1.219		.317	45°	31287	71287		
1.5695	1.220	1.356	.344	45°	31292			
1.5695	1.265	1.320	.280	45°	31286			
1.5700	1.243		.354	45°	31318			
1.5730	1.312		.219	45°	30643+5	70643+5		
1.5748	1.141		.394	45°	39041	79041	99041	
1.5748	1.181		.374	45°		71181		
1.5748	1.260		.394	45°	39040	79040		
1.5748	1.299		.315	45°		79078		
1.5748	1.319		.354	45°	31296			
1.5780	1.313		.250	45°	30644+10			
1.5803	1.299		.315	45°			92434	
1.5823	1.180		.413	45°	31081	71081		
1.5827	1.319		.374	45°	31278			
1.5827	1.339		.295	45°		71017		
1.5827	1.368		.272	45°		71803		
1.5846	1.358		.287	45°		71418		
1.5890	1.250		.250	45°		71904		

* Special ID Features

VALVE SEAT PROGRESSIVE LISTING BY OUTSIDE DIAMETER

ACTUAL OD	ID	ID TOP TAPER	DEPTH	SEAT ANGLE	PART NUMBER SERIES			
					30000	70000	90000	"Killer Bee"
1.5945	1.260		.394	45°	39042	79042		
1.5953	1.181		.394	45°			92035	
1.5953	1.319		.394	45°			92052	
1.5980	1.438		.188	45°		72393		
1.5984	1.339		.276	45°		71018		
1.6000	1.181		.315	45°			92259	
1.6000	1.282		.299	45°		71371		
1.6000	1.300		.409	45°	32072			
1.6000	1.345	1.444	.400	45°	32089			
1.6020	1.322	*	.276	36.3°				72432C
1.6023	1.398		.315	45°			92124	
1.6050	1.310	1.428	.250	45°	32189	72189		
1.6090	1.250		.250	45°		71905		
1.6090	1.313		.219	45°		71841		
1.6090	1.313		.414	45°		72148		
1.6100	1.438		.188	45°		72394		
1.6142	1.181		.394	45°	39044	79044		
1.6142	1.220		.335	45°		71182		
1.6142	1.260		.315	45°		79079		
1.6142	1.260		.413	45°		72271		
1.6142	1.299		.394	45°	39043	79043	99043	
1.6142	1.339		.295	45°	31039	71039		
1.6201	1.374		.256	45°		71413		
1.6201	1.398		.256	45°		71813		
1.6220	1.319		.260	45°		71437		
1.6220	1.344		.197	45°		71946		
1.6245	1.322		.375	45°		70855		
1.6250	1.313		.250	45°	31196			
1.6260	1.319		.236	45°			92049	
1.6260	1.319		.413	45°		72270		
1.6260	1.320		.375	45°		71372		
1.6285	1.348	1.524	.365	45°		71924		
1.6289	1.359	1.500*	.250	30°		72305		
1.6299	1.398		.197	45°	31859			
1.6300	1.250		.219	45°	30661	70661		
1.6300	1.250		.250	45°	30662	70662		
1.6300	1.250		.313	45°	30663	70663		
1.6300	1.250		.375	45°	30853	70853		
1.6300	1.313		.219	45°	30649	70649	90649	
1.6300	1.313		.250	45°	30650	70650		
1.6300	1.313		.281	45°	31488	71488		
1.6300	1.313		.313	45°	30651	70651		
1.6300	1.313		.395	45°	30854	70854		
1.6300	1.321	1.549*	.393	60°		72224		
1.6300	1.323	1.580*	.240	45°	32213			
1.6300	1.334		.313	45°		70642		
1.6300	1.344		.250	45°	31489	71489		
1.6300	1.348		.218	45°	30857			
1.6300	1.375		.219	45°	30648	70648		
1.6300	1.375		.250	45°	30646	70646		
1.6300	1.375		.313	45°	30732	70732		
1.6300	1.406		.250	45°	31482			
1.6310	1.187		.450	45°	32425			
1.6310	1.298		.317	45°	31218			
1.6310	1.320		.300	45°	31223			
1.6310	1.344		.313	45°	31164	71164		
1.6310	1.375		.188	45°	31046	71046		

* Special ID Features

VALVE SEAT PROGRESSIVE LISTING BY OUTSIDE DIAMETER

ACTUAL OD	ID	ID TOP TAPER	DEPTH	SEAT ANGLE	PART NUMBER SERIES			
					30000	70000	90000	"Killer Bee"
1.6320	1.250		.312	45°	31332			
1.6320	1.298	1.422	.317	45°	31236			
1.6320	1.329		.280	45°	30860	70860		
1.6320	1.333		.237	45°	31690			
1.6339	1.299		.394	45°	39045	79045	99045	
1.6339	1.378		.315	45°			92074	
1.6340	1.260	1.340	.394	45°	31323			
1.6344	1.375		.256	45°	32287			
1.6346	1.319		.394	45°			92384	
1.6350	1.375		.219	45°	30648+5			
1.6370	1.437		.350	45°	32173			
1.6386	1.339		.315	45°	31019	71019		
1.6417	1.339		.250	45°		71020		
1.6450	1.375		.250	45°	30864	70864		
1.6450	1.406		.187	45°		71996		
1.6460	1.312		.350	45°	31226			
1.6470	1.300		.325	45°		72129		
1.6500	1.280	1.500*	.350	45°	32076	72076		
1.6500	1.340		.350	45°	32069			
1.6500	1.340		.425	45°	32138			
1.6500	1.367		.380	45°	32187			
1.6500	1.390	1.489	.400	45°	32091			
1.6500	1.400	1.566	.375	45°	32088			
1.6500	1.408	1.580*	.375	45°	31979			
1.6535	1.220		.394	45°	39047	79047		
1.6535	1.260		.374	45°	31183	71183		
1.6535	1.299		.315	45°		79080		
1.6535	1.299		.335	45°		71184		
1.6535	1.299		.374	45°		71931		
1.6535	1.313		.250	45°		71852		
1.6535	1.338		.394	45°	39046	79046		
1.6535	1.365	1.487	.250	40°		72343		
1.6560	1.313		.375	45°	31272			
1.6560	1.350	1.626*	.375	45°	31279			
1.6565	1.246	1.546*	.375	55°	31478			
1.6570	1.312		.395	45°		71697		
1.6591	1.299		.315	45°			92435	
1.6600	1.412		.256	45°		72178		
1.6614	1.319		.413	45°	31082	71082		
1.6614	1.398		.315	45°		71810		
1.6634	1.378		.315	45°		71421		
1.6690	1.372	1.429	.272	37°	30868			
1.6694	1.339		.177	45°	31308			
1.6700	1.350		.375	45°				22194C
1.6732	1.338		.394	45°	39048	79048		
1.6772	1.417		.315	45°		71373		
1.6811	1.398		.335	45°	31811	71811		
1.6831	1.469		.295	45°		71390		
1.6875	1.410		.365	20°			91828	
1.6900	1.370		.500	R.125				22264C
1.6920	1.312		.219	45°	30674	70674		
1.6920	1.312		.250	45°	30675	70675		
1.6920	1.312		.313	45°	30676	70676		
1.6920	1.312		.375	45°	31270			
1.6920	1.372	1.492	.281	53°		71960		
1.6920	1.375		.188	45°	31042			
1.6920	1.375		.219	45°	30677	70677		

* Special ID Features

VALVE SEAT PROGRESSIVE LISTING BY OUTSIDE DIAMETER

ACTUAL OD	ID	ID TOP TAPER	DEPTH	SEAT ANGLE	PART NUMBER SERIES			
					30000	70000	90000	"Killer Bee"
1.6920	1.375		.250	45°	30678	70678		
1.6920	1.375		.313	45°	30679	70679		
1.6920	1.375		.375	45°	30871	70871		
1.6920	1.406		.250	45°	30670	70670		
1.6920	1.438		.156	45°	30872			
1.6920	1.438		.188	45°	30873	70873		
1.6920	1.438		.219	45°	30664	70664		
1.6920	1.438		.250	45°	30673	70673		
1.6920	1.438		.313	45°	30733	70733		
1.6921	1.312		.315	45°		71374		
1.6925	1.344		.313	45°	30559	70559		
1.6925	1.406		.313	45°	31490			
1.6929	1.260		.394	45°	39050	79050		
1.6929	1.299		.335	45°	31186	71186	91186	
1.6929	1.339		.325	45°		71185		
1.6929	1.350		.315	45°		71406		
1.6929	1.378		.315	45°		79081		
1.6929	1.378		.394	45°	39049	79049		
1.6929	1.385		.315	45°		71391		
1.6930	1.437	1.625*	.250	30°		71947		
1.6937	1.394		.305	45°	31856			
1.6940	1.300		.360	45°	31083			
1.6940	1.385	1.520	.305	45°	30190			
1.6940	1.450		.297	45°	30881			
1.6945	1.375		.295	45°	31707	71707		
1.6945	1.390	1.480	.305	45°	31288			
1.6950	1.250		.375	45°		71701+5		
1.6970	1.438		.219	45°		70664+5		
1.6980	1.419	1.598*	.264	45°		72389		
1.7028	1.417		.315	45°	31021	71021		
1.7035	1.394		.315	45°	31857			
1.7059	1.384		.250	45°		71085		
1.7059	1.384		.354	45°	31084	71084		
1.7126	1.378		.394	45°	39051	79051		
1.7140	1.313		.313	45°		71503		
1.7200	1.280		.350	45°	32356			
1.7205	1.457		.335	45°		71814		
1.7210	1.360	1.565*	.264	45°		72218		
1.7220	1.358		.265	45°	31709	71709	91709	
1.7320	1.457	1.457*	.365	R.212		72242		
1.7323	1.299		.394	45°	39053	79053	99053	
1.7323	1.339		.374	45°	31187	71187		
1.7323	1.417		.276	45°		71375		
1.7323	1.417		.315	45°		79082		
1.7323	1.417		.394	45°	39052			
1.7327	1.417		.238	45°			92101	
1.7330	1.455	1.620	.365	45°		71925		
1.7333	1.335		.372	45°	31110			
1.7362	1.280		.315	45°			92260	
1.7374	1.398		.274	45°		72342		
1.7374	1.417		.354	45°		72215		
1.7420	1.487		.268	45°	31907			
1.7421	1.457		.315	45°	31086	71086		
1.7421	1.480	1.642*	.282	44°	32240			
1.7425	1.457		.250	45°			92103	
1.7500	1.375	*	.550	-				32233C
1.7520	1.181		.394	45°	39056	79056		

* Special ID Features

VALVE SEAT PROGRESSIVE LISTING BY OUTSIDE DIAMETER

ACTUAL OD	ID	ID TOP TAPER	DEPTH	SEAT ANGLE	PART NUMBER SERIES			
					30000	70000	90000	"Killer Bee"
1.7520	1.417		.394	45°	39071	79071		
1.7520	1.417		.433	45°	39055	79055		
1.7524	1.437		.157	45°	31862			
1.7550	1.250		.250	45°		71128		
1.7550	1.312		.395	45°	31232			
1.7550	1.313		.250	45°	30889			
1.7550	1.375		.219	45°	30652	70652		
1.7550	1.375		.250	45°	30653	70653		
1.7550	1.375		.313	45°	30654	70654		
1.7550	1.437		.375	45°	32350			
1.7550	1.438		.219	45°	30655	70655		
1.7550	1.438		.250	45°	30656	70656		
1.7550	1.438	1.500	.302	45°	31117			
1.7550	1.438		.313	45°	30657	70657		
1.7550	1.468		.220	45°	32273			
1.7550	1.468		.312	45°	32109			
1.7550	1.500		.219	45°	30658	70658		
1.7550	1.500		.250	45°	30659	70659	90659	20659C
1.7550	1.500		.313	45°		70660		
1.7559	1.378		.295	45°		71381		
1.7559	1.476		.281	45°	31863			
1.7560	1.313		.313	45°		71165		
1.7560	1.437		.302	45°		71221		
1.7560	1.438	1.500	.188	45°	31045			
1.7560	1.445	1.617	.310	45°	31215			
1.7560	1.594		.278	45°	31209			
1.7570	1.375		.375	45°	31129	71129		
1.7570	1.375		.450	45°	31900			
1.7570	1.380	1.717*	.400	58°				22199C
1.7570	1.385	1.559	.380	45°		70127		
1.7570	1.410	1.560	.315	45°	30165			
1.7570	1.457		.312	45°	31317			
1.7570	1.468		.276	45°	31715			
1.7618	1.457		.335	45°		71392		
1.7648	1.511		.265	45°	31994			
1.7717	1.339		.472	45°	39058	79058	99058	
1.7717	1.358		.394	45°		71227		
1.7717	1.417		.315	45°		79083		
1.7717	1.457		.335	45°		71393		
1.7717	1.457		.472	45°	39057	79057	99057	
1.7725	1.433		.270	45°		72416		
1.7800	1.620		.188	45°		72395		
1.7810	1.476		.311	45°		71257	91257	
1.7815	1.496		.315	45°		71404		
1.7815	1.535		.295	45°		71472		
1.7840	1.469		.290	45°		71230		
1.7856	1.514	1.680*	.275	R.159	32327			
1.7863	1.406		.288	45°	31087	71087		
1.7863	1.500		.288	45°		72002		
1.7874	1.409		.297	45°		71427		
1.7913	1.440		.374	45°		71801		
1.7913	1.457		.472	45°	39059	79059		
1.7969	1.418		.390	45°	31088	71088		
1.8045	1.375	1.610*	.375	45°	31825			
1.8060	1.417		.292	45°			91933	
1.8100	1.535	1.731*	.364	30°		72392		
1.8110	1.339		.472	45°	39061	79061		

* Special ID Features

VALVE SEAT PROGRESSIVE LISTING BY OUTSIDE DIAMETER

ACTUAL OD	ID	ID TOP TAPER	DEPTH	SEAT ANGLE	PART NUMBER SERIES			
					30000	70000	90000	"Killer Bee"
1.8110	1.398		.394	45°		71188		
1.8110	1.496		.315	45°		79084		
1.8110	1.496		.472	45°	39060	79060		
1.8120	1.450		.197	30°	31843			
1.8120	1.540	1.650*	.365	30°		72359		
1.8125	1.540		.365	60°	31827		91827	
1.8134	1.567	1.714*	.282	44°	32238			
1.8150	1.392		.297	45°		71376		
1.8161	1.505		.280	45°		71355		
1.8170	1.375		.313	45°		70903		
1.8170	1.438		.313	45°	30905	70905		
1.8170	1.484		.250	45°	31089			
1.8170	1.500		.375	45°	31131	71131		
1.8170	1.540		.365	30°	31726			
1.8170	1.562	1.655	.365	45°		70542		
1.8175	1.438		.375	45°	31459			
1.8175	1.625		.219	45°	31283			
1.8179	1.500		.256	45°	32008			
1.8180	1.414		.334	45°		71954		
1.8180	1.438		.219	45°	31269	71269		
1.8180	1.438		.250	45°	30904			
1.8180	1.438		.312	45°	32111			
1.8180	1.468		.313	45°	30680	70680	90680	
1.8180	1.500	1.625	.219	45°	30530	70530		
1.8180	1.500		.219	45°	30668	70668		
1.8180	1.500		.250	45°	30672	70672		
1.8180	1.500		.281	45°	30741			
1.8180	1.500		.312	45°	30907	70907	90907	20907C
1.8180	1.520		.177	45°		71961		
1.8180	1.520		.300	45°	31910			
1.8180	1.520		.334	45°		71951		
1.8180	1.563		.219	45°	30667	70667		
1.8180	1.563		.250	45°	30671	70671		
1.8180	1.563		.280	45°	32379			
1.8180	1.563		.313	45°	31000	71000		
1.8190	1.375		.450	45°	32426			
1.8190	1.405		.315	45°	31137	71137		
1.8190	1.440	1.508	.316	45°	31327			
1.8190	1.490	1.600	.305	45°	30030			
1.8190	1.496		.157	45°	31307			
1.8195	1.440	1.515	.315	45°	31284			
1.8195	1.500	1.555	.278	45°	31285			
1.8195	1.570		.284	60°		72011		
1.8200	1.435	1.505	.314	45°	31319			
1.8203	1.570	1.660*	.282	30°		72306		
1.8303	1.437		.375	45°	31090	71090		
1.8307	1.496		.472	45°	39062	79062		
1.8307	1.575		.276	45°			92050	
1.8358	1.496		.285	45°	31433	71433		
1.8500	1.500		.281	60°			92373	
1.8504	1.417		.472	45°	39065	79065	99065	
1.8504	1.437		.394	45°	31228	71228		
1.8504	1.535		.472	45°	39063			
1.8530	1.500		.273	30°	31734	71734		
1.8535	1.500	*	.272	30°		72364		
1.8540	1.499	1.619*	.273	60°		72217		
1.8545	1.570	1.711*	.249	45°		72376		

* Special ID Features

VALVE SEAT PROGRESSIVE LISTING BY OUTSIDE DIAMETER

ACTUAL OD	ID	ID TOP TAPER	DEPTH	SEAT ANGLE	PART NUMBER SERIES			
					30000	70000	90000	"Killer Bee"
1.8545	1.576	1.788*	.230	45°		72232		
1.8550	1.500		.281	60°			92373+5	
1.8560	1.635		.280	45°		71268		
1.8567	1.457		.339	45°		71339		
1.8600	1.500		.281	60°			92373+10	
1.8661	1.535		.315	45°		71377		
1.8700	1.500		.281	60°			92373+20	
1.8701	1.535		.472	45°	39066	79066		
1.8740	1.435		.382	45°		71378		
1.8785	1.565	1.725*	.438	30°		72307		
1.8800	1.500		.250	45°	30919	70919		
1.8800	1.500		.375	45°	31091	71091		31091C
1.8800	1.562	1.740	.187	45°		71930		
1.8800	1.562		.250	45°	30509	70509		
1.8800	1.562		.312	45°	30923	70923		
1.8800	1.563		.438	30°		71739		
1.8800	1.594		.375	45°	32119			
1.8800	1.625	1.775	.219	45°		71955		
1.8810	1.437		.450	45°	32427			
1.8810	1.500		.313	45°	30920	70920		
1.8810	1.563		.219	45°	31238	71238		
1.8810	1.575		.317	45°	31217			
1.8810	1.594		.250	45°	30687	70687		
1.8810	1.594		.313	45°	30688	70688		
1.8810	1.594		.375	45°			92026	
1.8810	1.625		.219	45°	30681	70681		
1.8810	1.625		.250	45°	30682	70682		
1.8810	1.625		.281	45°	30683			
1.8810	1.625		.313	45°	30684	70684		
1.8810	1.625		.453	45°		70686		
1.8819	1.575		.315	45°		71394		
1.8820	1.505	1.689	.380	45°		70138		
1.8820	1.575	1.692	.317	45°	31034	71034		
1.8820	1.575		.320	45°	31316			
1.8820	1.600		.252	45°	31092	71092		
1.8890	1.476		.394	45°		71189		
1.8898	1.417		.335	45°			92261	
1.8898	1.417	1.668*	.360	35°			92391	
1.8898	1.457		.472	45°	39069	79069		
1.8898	1.496		.433	45°	39068	79068		
1.8898	1.575		.472	45°	39067	79067		
1.8900	1.476		.434	45°	31894			
1.8917	1.575		.315	45°		71913		
1.8976	1.457		.284	45°		72221		
1.9120	1.625		.281	45°	31746	71746		
1.9181	1.703		.197	45°	31945			
1.9232	1.634		.177	45°	31860			
1.9290	1.516		.434	45°	31895			
1.9291	1.516		.394	45°		71190		
1.9291	1.654		.315	45°		71191		
1.9420	1.563		.375	45°	32115			
1.9430	1.563		.219	45°	30933	70933		
1.9430	1.563		.250	45°	30932	70932		
1.9430	1.563		.313	45°		71496		
1.9430	1.625		.250	45°	31497	71497		
1.9430	1.625		.281	45°	31749			
1.9430	1.625		.312	45°	31134	71134		

* Special ID Features

VALVE SEAT PROGRESSIVE LISTING BY OUTSIDE DIAMETER

ACTUAL OD	ID	ID TOP TAPER	DEPTH	SEAT ANGLE	PART NUMBER SERIES			
					30000	70000	90000	"Killer Bee"
1.9430	1.625		.375	45°	31471			
1.9430	1.688		.188	45°	30935			
1.9430	1.688		.219	45°	30936			
1.9430	1.688		.281	45°	32378			
1.9435	1.573		.379	45°	31281			
1.9435	1.625		.219	45°	31262			
1.9440	1.500		.313	45°	31166	71166		
1.9440	1.688		.250	45°	30560	70560		
1.9450	1.500		.450	45°	31898			
1.9510	1.691	1.860*	.262	R.187	32324			
1.9550	1.695		.270	45°	32396			
1.9570	1.665		.280	45°	32196			
1.9600	1.625		.375	45°				22252C
1.9600	1.655		.375	45°				32366C
1.9620	1.597	1.597*	.365	R.178		72241		
1.9685	1.500		.335	45°			92282	
1.9685	1.535		.394	45°		71192		
1.9685	1.614		.315	45°		72065		
1.9685	1.693		.295	45°		72040	92040	
1.9728	1.693		.394	45°		72331		
1.9800	1.694		.250	45°	30297			
1.9807	1.693		.402	45°		72332		
1.9886	1.693		.409	45°		72333		
2.0000	1.580		.375	45°				
2.0000	1.593	1.790	.375	45°	32163			
2.0000	1.600	1.870*	.375	45°	32358			
2.0000	1.665	1.837	.375	60°	32078			
2.0000	1.745	1.844	.400	45°	32237			
2.0005	1.602		.377	45°	32090			
2.0006	1.730	1.906	.264	49°	32017	72017		22017C
2.0010	1.712		.385	30°		72401		
2.0030	1.690	*	.280	30°	31756	71756		
2.0035	1.688		.438	45°			92362	
2.0050	1.813		.219	45°	31758			
2.0060	1.600		.375	45°	30952	70952		
2.0060	1.625		.219	45°		71988		
2.0060	1.625		.250	45°	30723			
2.0060	1.625		.281	45°	30724	70724		
2.0060	1.625		.297	45°	30725		90725	
2.0060	1.625		.313	45°		70726		
2.0060	1.625		.344	45°	30727	70727		
2.0060	1.625		.375	45°	30728			
2.0060	1.625		.438	45°	30729	70729		
2.0060	1.630		.280	0°	30730			
2.0060	1.688		.188	45°	31829		91829	
2.0060	1.688		.219	45°		72344		
2.0060	1.688		.219	45°	30698	70698		
2.0060	1.688	1.900*	.219	30°	31957	71957		
2.0060	1.688		.250	45°	30699	70699		
2.0060	1.688		.282	45°	30700	70700		
2.0060	1.688	1.949*	.282	35°	32408			
2.0060	1.688		.313	45°	30701			
2.0060	1.688		.375	45°	30702			
2.0060	1.688		.438	45°	30703			
2.0060	1.750		.188	45°	30690	70690		
2.0060	1.750		.219	45°	30691	70691		
2.0060	1.750	1.880	.219	45°		72298		
2.0060	1.750		.250	45°	30692	70692		

* Special ID Features

VALVE SEAT PROGRESSIVE LISTING BY OUTSIDE DIAMETER

ACTUAL OD	ID	ID TOP TAPER	DEPTH	SEAT ANGLE	PART NUMBER SERIES			
					30000	70000	90000	"Killer Bee"
2.0060	1.750		.313	45°	30694			
2.0079	1.575		.217	45°		71415		
2.0079	1.575		.413	45°		71193		
2.0080	1.700	*	.280	30°		72363		
2.0110	1.625		.281	45°			90725+5	
2.0110	1.630		.280	0°			91829+5	
2.0110	1.712		.385	30°	31756+10			
2.0150	1.670		.282	0°			91959	
2.0160	1.625		.281	45°			90725+10	
2.0180	1.594		.281	45°		71765		
2.0260	1.625		.281	45°			90725+20	
2.0270	1.772		.177	45°	32004	72004		
2.0276	1.726		.217	45°	31341			
2.0360	1.625		.281	45°			90725+30	
2.0441	1.732		.406	45°	32034		92034	
2.0472	1.614		.413	45°	31194	71194		
2.0485	1.765	1.809	.250	45°	32188			
2.0485	1.771	1.928*	.339	30°		72361		
2.0485	1.781		.344	30°	31766			
2.0500	1.750		.270	45°	32397			
2.0508	1.575		.364	45°		71816		
2.0600	1.562		.450	45°	32208			
2.0669	1.750		.413	45°		72269		
2.0673	1.693		.354	45°	31401	71401		
2.0675	1.748	2.026*	.392	45°		72223		
2.0680	1.687		.450	45°	32428			
2.0680	1.688		.281	45°	31768	71768		
2.0680	1.750		.281	45°	31769			
2.0680	1.770	2.016*	.250	45°	32212			
2.0680	1.812		.250	45°	30963	70963		
2.0680	1.813		.188	45°		71770		
2.0680	1.813	1.875	.250	45°	30964			
2.0685	1.750		.219	45°	31249	71249		
2.0695	1.750		.420	45°		72424		
2.0709	1.752		.236	45°			92048	
2.0835	1.732		.406	45°			92383	
2.0866	1.654		.413	45°	31195	71195	91195	
2.0880	1.692		.299	45°	31771			
2.0902	1.697		.382	45°	31475			
2.0905	1.693	1.929	.327	20°			92400	
2.0906	1.693	1.990	.303	70°				17846C
2.0906	1.693		.354	45°		71430		
2.0906	1.693	1.990	.374	70°		72031		
2.0906	1.693		.394	45°	31424	71424		
2.0933	1.693		.354	45°		72382		
2.0945	1.693		.276	45°			97999	
2.1000	1.818		.431	45°	32071			
2.1050	1.765		.375	45°	31310			
2.1098	1.697		.402	45°	31093	71093		
2.1102	1.693		.354	45°		71447		
2.1102	1.693		.394	45°		71441		
2.1140	1.693		.394	45°			92399	
2.1200	1.812		.375	45°	31454			
2.1250	1.800		.437	45°			92186	
2.1300	1.812		.250	45°	30557	70557		
2.1300	1.812	2.030	.437	45°	32139		92139	
2.1300	1.813		.313	45°	31124			

* Special ID Features

VALVE SEAT PROGRESSIVE LISTING BY OUTSIDE DIAMETER

ACTUAL OD	ID	ID TOP TAPER	DEPTH	SEAT ANGLE	PART NUMBER SERIES			
					30000	70000	90000	"Killer Bee"
2.1300	1.875		.219	45°	30974			
2.1300	1.875		.250	45°	30537	70537		
2.1300	1.906		.177	45°	32003			
2.1300	1.906		.234	45°		71473		
2.1305	1.750		.219	45°		71777		
2.1305	1.750		.250	45°		71776		
2.1305	1.813		.188	45°	31779		91779	
2.1305	1.906		.250	45°	31498	71498		
2.1310	1.810		.375	45°		71990		
2.1310	1.813		.219	45°	31240	71240		
2.1320	1.690		.450	45°	31897			
2.1339	1.693		.339	45°		71338	91338	
2.1339	1.752		.287	45°		71417		
2.1340	1.693		.394	45°		72216		
2.1360	1.652	1.978*	.310	52°		72171		
2.1360	1.705	1.978*	.295	60°		72172		
2.1370	1.700		.400	45°		71504		
2.1400	1.812		.375	45°	31830			
2.1516	1.720		.394	45°			92402	
2.1600	1.750		.350	45°		72347		
2.1600	1.750		.375	45°			92022	
2.1640	1.750		.450	45°	32209			
2.1654	1.732		.472	45°	31141	71141		
2.1700	1.732		.433	45°		71783+5		
2.1700	1.800		.375	45°	32354			
2.1701	1.751		.336	80°	32041			
2.1701	1.751		.336	80°		72044		
2.1856	1.820	*	.338	36.8°		72431		
2.1925	1.875		.375	45°	32349			
2.1930	1.937		.250	45°	31282			
2.1935	1.875		.281	45°	30984	70984		
2.1940	1.800		.450	45°	32429			
2.1940	1.812		.250	45°	31135			
2.1940	1.812		.375	45°		72276		
2.2000	1.720	1.863	.312	45°	32093			
2.2000	1.830	1.983	.312	45°	32087			
2.2500	1.850		.320	45°				22193C
2.2500	1.947	2.120	.312	45°	32357			
2.2550	1.875		.375	45°	31787	71787		
2.2555	1.820		.375	45°				31949C
2.2555	1.875		.313	45°		71470		
2.2555	1.938		.188	45°	30989	70989		
2.2560	1.870		.450	45°	32430			
2.2560	1.938		.219	45°		71261		
2.2560	1.938		.375	45°	31983			
2.2560	1.960		.250	60°			92156	
2.2590	1.960		.250	45°		71995		
2.2590	1.960	2.135*	.250	45°		72246		
2.3120	1.937		.220	45°	32272			
2.3120	1.937		.312	45°	32108			
2.3180	2.000		.250	45°	30991	70991	90991	
2.3180	2.000		.375	45°	32118			
2.3500	1.970	2.290*	.375	53°	31456			
2.3500	1.970		.375	45°	31981			
2.3657	2.011		.350	45°	31476			
2.3665	2.008		.350	45°		72328		
2.3744	2.008		.358	45°		72329		

* Special ID Features

VALVE SEAT PROGRESSIVE LISTING BY OUTSIDE DIAMETER

ACTUAL OD	ID	ID TOP TAPER	DEPTH	SEAT ANGLE	PART NUMBER SERIES			
					30000	70000	90000	"Killer Bee"
2.3800	1.904		.375	45°				22228C
2.3810	1.927	2.140*	.319	30°		72360		
2.3810	2.030		.323	60°	31845			
2.3819	2.000		.394	45°		71815		
2.3823	2.008		.366	45°		72330		
2.4074	1.956	2.287*	.284	30°				17563C
2.4094	1.890		.354	45°				17904C
2.4430	2.125		.375	45°	32370			
2.4505	2.000		.377	45°				22018C
2.4600	2.040		.375	45°				22365C
2.5000	2.040		.375	45°				22251C

* Special ID Features

VALVE SEAT PROGRESSIVE LISTING BY INSIDE DIAMETER

ID	ID TOP TAPER	ACTUAL OD	DEPTH	SEAT ANGLE	PART NUMBER SERIES			
					30000	70000	90000	"Killer Bee"
0.709		0.9252	.236	45°		71357		
0.709		0.9449	.256	45°		71167		
0.709		0.9449	.315	45°		72334	92334	
0.709		0.9547	.276	45°		72066		
0.709		1.0236	.276	45°			92283	
0.709		1.0240	.355	45°	31872			
0.709		1.1024	.236	45°			92290	
0.709		1.1417	.394	45°		72338		
0.709		1.2205	.295	45°			92369	
0.748		0.9843	.315	45°		72335	92335	
0.750		1.0045	.188	45°		71600		
0.750		1.1310	.250	45°	31143	71143		
0.765		0.9500	.250	45°	32131			
0.781		1.0690	.250	45°		71142		
0.787		0.9843	.276	45°		71446		
0.787		0.9882	.236	45°		71346		
0.787		0.9890	.236	45°	31002	71002		
0.787		0.9902	.236	45°		71349		
0.787		1.0236	.315	45°		72336		
0.787		1.0512	.224	45°	31003	71003		
0.787		1.0630	.315	45°			92404	
0.787		1.0689	.236	45°		71383		
0.787		1.1020	.355	45°	31874			
0.787		1.1024	.315	45°		71168		
0.787		1.1811	.394	45°	39011	79011	99011	
0.787		1.1921	.315	45°			92255	
0.790		1.0690	.260	45°	31047	71047		
0.807		1.0559	.224	45°		71350		
0.807		1.1024	.256	45°		71428		
0.809		1.1661	.280	45°		71358		
0.825		1.0490	.298	45°				32130C
0.825		1.1320	.285	45°	31048	71048		
0.825		1.2250	.350	45°		72086		
0.827		1.0335	.177	45°		71398		
0.827		1.0472	.236	45°		71382		
0.827		1.0551	.244	45°		71395		
0.827		1.0630	.394	45°		72337		
0.827		1.1417	.335	45°		71169		
0.827		1.1420	.375	45°	31875			
0.827		1.2205	.394	45°	39014	79014	99014	
0.835		1.1450	.295	45°				32210C
0.864		1.0722	.276	45°			92027	
0.866		1.1024	.394	45°	39006	79006	99006	
0.866		1.1083	.256	45°		71396		
0.866		1.1220	.394	45°	39007	79007	99007	
0.866		1.1810	.375	45°	31876			
0.866		1.1811	.335	45°	31170	71170		
0.866		1.2598	.335	45°			92289	
0.866		1.2598	.394	45°	39017	79017	99017	
0.871		1.0681	.254	45°	31096			
0.871		1.1299	.191	45°	31097			
0.871		1.1933	.254	45°	31098			
0.874		1.0898	.250	45°		71429		
0.874		1.1516	.250	45°		71431		
0.875		1.1300	.219	45°	30754			
0.875		1.1921	.250	45°		71352		
0.875		1.1925	.219	45°		72372		

* Special ID Features

VALVE SEAT PROGRESSIVE LISTING BY INSIDE DIAMETER

ID	ID TOP TAPER	ACTUAL OD	DEPTH	SEAT ANGLE	PART NUMBER SERIES			
					30000	70000	90000	"Killer Bee"
0.875		1.1940	.250	45°		71144		
0.875		1.2560	.250	45°	31151	71151		
0.890		1.1102	.236	45°		71807		
0.890		1.1122	.236	45°		71812		
0.905		1.1940	.257	45°	31146	71146		
0.905	1.000	1.2570	.230	45°	30230			
0.905		1.2992	.315	45°		71425		
0.906		1.0984	.256	45°		71804		
0.906		1.1280	.303	45°		72043		
0.906		1.1417	.394	45°	39008	79008	99008	
0.906		1.1496	.256	45°		71410	91410	
0.906		1.1614	.275	45°		72250		
0.906		1.1614	.394	45°	39009	79009	99009	
0.906		1.1700	.275	45°	32198			
0.906		1.1811	.394	45°	39010	79010	99010	
0.906		1.2008	.394	45°	39012	79012	99012	
0.906		1.2205	.335	45°	31171	71171		
0.906		1.2560	.313	45°	31149	71149		
0.906	1.024	1.2677	.248	45°			92042	
0.906	1.024	1.2736	.248	45°			91450	
0.906		1.2992	.394	45°	39020	79020	99020	
0.910		1.2252	.283	45°		71354		
0.910	1.070	1.2560	.281	45°	31333			
0.910		1.2570	.285	45°	31054	71054		
0.925		1.1358	.217	45°			92047	
0.925		1.1640	.220	45°		72266		
0.925		1.1819	.244	45°	31049	71049		
0.929		1.1933	.256	45°		71435		
0.930		1.2570	.325	45°	31612			
0.933		1.1831	.197	45°			92303	
0.933		1.1933	.254	45°	31099			
0.933		1.2559	.254	45°	31105	71105		
0.935		1.1945	.235	45°	31868			
0.938		1.1940	.250	45°	31145	71145		
0.938		1.2560	.188	45°	31152	71152		
0.938		1.3810	.313	45°		71156		
0.941		1.2407	.335	45°		71434		
0.945		1.3386	.335	45°			92256	
0.945		1.1339	.339	45°		72339		
0.945		1.1732	.236	45°		71444		
0.945		1.1811	.335	45°		71411		
0.945		1.1870	.354	45°		71436		
0.945		1.2047	.226	45°		71937		
0.945		1.2205	.394	45°	39013	79013	99013	
0.945		1.2260	.204	45°		78000		
0.945		1.2402	.394	45°	39015	79015	99015	
0.945		1.2598	.260	45°		72381		
0.945		1.2598	.335	45°		71172		
0.945		1.2598	.354	45°		71311	91311	
0.945		1.3386	.394	45°	39023	79023	99023	
0.949		1.1886	.319	45°		72279	92279	
0.960		1.1980	.295	45°				32182C
0.960	1.076	1.1990	.322	45°				72419C
0.965		1.2402	.315	45°			92262	
0.970		1.2570	.270	45°	31613			
0.975		1.2620	.250	30°		71621		
0.975		1.2820	.250	45°		71502		

* Special ID Features

VALVE SEAT PROGRESSIVE LISTING BY INSIDE DIAMETER

ID	ID TOP TAPER	ACTUAL OD	DEPTH	SEAT ANGLE	PART NUMBER SERIES			
					30000	70000	90000	"Killer Bee"
0.975		1.3020	.250	45°		71901		
0.975		1.3190	.280	45°	31058			
0.977		1.3190	.300	45°	31340			
0.982	1.065	1.2670	.320	45°	31313			
0.984		1.1850	.248	45°		71345		
0.984		1.1858	.248	45°		71004		
0.984		1.1870	.200	45°		71445		
0.984		1.1870	.248	45°	31005	71005		
0.984		1.2008	.256	45°	31051	71051		
0.984		1.2169	.250	45°			92106	
0.984		1.2205	.237	45°		71448		
0.984		1.2303	.315	45°		71414		
0.984		1.2598	.394	45°	39016	79016	99016	
0.984		1.2602	.315	45°	31808	71808		
0.984		1.2795	.394	45°	39018	79018	99018	
0.984		1.2854	.236	45°		71360		
0.984		1.2992	.315	45°		79072		
0.984		1.2992	.335	45°	31173	71173		
0.984		1.3634	.394	45°	31035	71035		
0.984		1.3780	.394	45°	39026	79026	99026	
0.989		1.2063	.276	45°			92033	
0.996		1.2559	.254	45°	31100			
1.000		1.2550	.250	45°	30764	70764		
1.000		1.2551	.250	45°		71359		
1.000		1.2560	.219	45°	31147	71147		
1.000		1.2560	.250	45°		71150	91150	
1.000		1.2560	.313	45°		71148		
1.000		1.3175	.250	45°	31056			
1.000		1.3190	.250	45°		71154		
1.000		1.3190	.313	45°	31155	71155		
1.000		1.3820	.280	45°	31064			
1.000		1.3820	.410	45°	31063			
1.000		1.5060	.406	45°		71906		
1.004		1.2854	.315	45°	31006	71006		
1.016		1.2402	.276	45°		72226		
1.023		1.2992	.394	45°	39019	79019	99019	
1.023		1.3189	.394	45°	39021	79021	99021	
1.024		1.4429	.335	45°			92257	
1.024		1.1811	.374	45°		72039		
1.024		1.2441	.236	45°		71384		
1.024		1.2480	.256	45°		71409		
1.024		1.2724	.236	45°		71347		
1.024		1.2854	.335	45°	31007	71007		
1.024		1.2992	.256	45°		71348	91348	
1.024		1.3190	.313	45°		72038		
1.024		1.3386	.335	45°	31174	71174		
1.024		1.3390	.375	45°	31880			
1.024		1.3780	.354	45°		71175		
1.024		1.4173	.394	45°	39029	79029	99029	
1.025		1.3433	.299	45°		71361		
1.028		1.2550	.227	45°	31043	71043		
1.042		1.3190	.238	45°	30779	70779		
1.045		1.3190	.316	45°		70563		
1.046		1.3170	.219	45°	30735			
1.046		1.3170	.250	45°	30736			
1.046		1.3170	.313	45°	30737			
1.048		1.3050	.227	45°	30739			

* Special ID Features

VALVE SEAT PROGRESSIVE LISTING BY INSIDE DIAMETER

ID	ID TOP TAPER	ACTUAL OD	DEPTH	SEAT ANGLE	PART NUMBER SERIES			
					30000	70000	90000	"Killer Bee"
1.050		1.3450	.290	45°	32132			
1.055		1.2550	.250	45°	31052			
1.059		1.3181	.254	45°	31101	71101		
1.059		1.3807	.254	45°	31102			
1.059		1.4433	.254	45°	31107			
1.060		1.3195	.275	45°	31628	71628		
1.061		1.2593	.276	45°			92028	
1.062		1.3190	.188	45°	30775			
1.062		1.3800	.219	45°	31125	71125		
1.063		1.2795	.217	45°			91914	
1.063		1.2827	.236	45°		71403		
1.063		1.2992	.217	45°		72195		
1.063		1.3170	.219	45°	31289	71289		
1.063		1.3189	.354	45°	31293			
1.063		1.3190	.250	45°		72177		
1.063		1.3190	.313	45°	31153	71153		
1.063		1.3268	.315	45°	31009	71009		
1.063		1.3386	.394	45°	31273	71273	91273	
1.063		1.3484	.315	45°	31060	71060		
1.063		1.3504	.315	45°		71356		
1.063		1.3583	.394	45°	39024	79024	99024	
1.063		1.3800	.188	45°	30786	70786		
1.063		1.3800	.250	45°	30788	70788		
1.063		1.3800	.313	45°	30787	70787		
1.063		1.4173	.354	45°		71176		
1.078		1.2840	.160	45°		72281		
1.079		1.2531	.335	45°		72278		
1.079		1.2728	.335	45°		72301		
1.079		1.2925	.335	45°		72302		
1.082		1.3228	.287	45°		71397		
1.083		1.2835	.354	45°		71800		
1.083		1.3071	.276	45°		71123		
1.083		1.3425	.236	45°		71385		
1.083		1.3450	.236	45°		72128		
1.085		1.3190	.305	45°	30562			
1.087		1.3530	.200	45°		71633+5		
1.093		1.3803	.250	45°		71363		
1.094		1.4110	.219	45°		72371		
1.098		1.4577	.352	45°	31113			
1.100	1.200	1.3750	.227	60°		72085		
1.100		1.3820	.300	45°	31139	71139		
1.100		1.4440	.315	45°	31329			
1.100	1.225	1.5050	.316	45°	30045			
1.100		1.5070	.315	45°	31074			
1.102		1.3051	.276	45°		71008	91008	
1.102		1.3386	.315	45°		79073		
1.102		1.3387	.177	45°		71306		
1.102		1.3445	.236	45°			91449	
1.102		1.3780	.197	45°		71408		
1.102		1.3780	.315	45°		79074		
1.102		1.3780	.394	45°	39025	79025	99025	
1.102	1.160	1.3820	.260	45°	30238	70238		
1.102		1.3878	.315	45°	31065	71065		
1.102		1.3976	.394	45°	39027	79027		
1.102		1.4567	.354	45°	31068	71068		
1.102		1.4961	.394	45°	39035	79035	99035	
1.102		1.5051	.335	45°			92258	

* Special ID Features

VALVE SEAT PROGRESSIVE LISTING BY INSIDE DIAMETER

ID	ID TOP TAPER	ACTUAL OD	DEPTH	SEAT ANGLE	PART NUMBER SERIES			
					30000	70000	90000	"Killer Bee"
1.105		1.4440	.322	45°	30806			
1.114		1.3661	.295	45°	31061	71061		
1.120		1.3820	.325	45°		71635		
1.121		1.3807	.254	45°	31103			
1.122		1.2913	.346	45°		72340		
1.122		1.5051	.343	45°		71367		
1.123		1.3190	.300	45°	31320	71320		
1.125		1.3800	.188	45°	30790	70790		
1.125		1.3800	.219	45°	30558	70558		
1.125		1.3800	.250	45°	30791	70791		
1.125		1.3800	.375	45°		70792		
1.125		1.3810	.266	45°	31157	71157		
1.125		1.4010	.266	45°		71838		
1.125		1.4210	.266	45°		71839		
1.125		1.4421	.250	45°		71380		
1.125		1.4421	.354	45°		71364		
1.125		1.4425	.250	45°	30802	70802		
1.125		1.4425	.313	45°	30803	70803		
1.125		1.4840	.219	45°		71903		
1.125		1.5050	.188	45°	30706	70706		
1.125		1.5050	.219	45°	30707	70707		
1.125		1.5050	.250	45°	30708			
1.125		1.5050	.313	45°	30709	70709		
1.125		1.5690	.313	45°		71163		
1.126		1.3268	.250	45°	31010	71010	91010	
1.126		1.3307	.250	45°		71438		
1.126		1.3484	.250	45°		71011		
1.126		1.4016	.158	45°		71918		
1.126		1.4421	.315	45°	31013	71013		
1.126		1.4425	.188	45°	31225	71225		
1.126		1.4425	.219	45°	30801	70801		
1.130		1.4429	.315	45°		71407		
1.135	1.250	1.4440	.316	45°	30809			
1.140		1.4445	.237	45°	31656			
1.140	1.250	1.5050	.325	45°	30105	70105		
1.141		1.3920	.318	45°	32183			
1.141		1.4370	.394	45°	39030	79030	99030	
1.141		1.5354	.394	45°	39038	79038		
1.141		1.5748	.394	45°	39041	79041	99041	
1.142		1.3583	.295	45°			92075	
1.142		1.4272	.315	45°		71420		
1.142		1.3268	.295	45°			92125	
1.142		1.3615	.220	60°	32265			
1.142		1.3701	.256	45°		71809		
1.142		1.3701	.283	45°		71362		
1.142		1.3976	.394	45°	31274	71274		
1.142		1.4016	.315	45°	31012	71012		
1.142		1.4100	.275	45°	32197			
1.142		1.4173	.394	45°	39028	79028	99028	
1.142		1.4445	.336	45°	31658			
1.142		1.4449	.315	45°		71439		
1.142		1.4685	.315	45°		71365		
1.142		1.4960	.434	45°	32437			
1.142		1.4961	.354	45°		71178		
1.148		1.5008	.283	45°		71366		
1.150		1.4445	.257	45°	31659			
1.152		1.4220	.315	45°	31066	71066		

* Special ID Features

VALVE SEAT PROGRESSIVE LISTING BY INSIDE DIAMETER

ID	ID TOP TAPER	ACTUAL OD	DEPTH	SEAT ANGLE	PART NUMBER SERIES			
					30000	70000	90000	"Killer Bee"
1.152		1.4236	.250	45°		71412		
1.157		1.3248	.260	45°			92222	
1.161		1.3976	.374	45°	31294			
1.166		1.3638	.276	45°			92032	
1.180	1.280	1.5060	.214	45°		71207		
1.180	1.345	1.5060	.307	45°	31258	71258		
1.180	1.318	1.5070	.305	45°	30031			
1.180	1.450	1.5510	.320	45°	31972			
1.180		1.5690	.305	45°	31079			
1.180		1.5695	.316	45°	31674			
1.180		1.5823	.413	45°	31081	71081		
1.181		1.3839	.291	45°		71805		
1.181		1.3860	.260	45°		72286		
1.181		1.4055	.339	45°		71423		
1.181		1.4173	.315	45°		79075		
1.181		1.4440	.280	45°	31646			
1.181		1.4567	.315	45°	31069	71069		
1.181		1.4567	.394	45°	39031	79031	99031	
1.181		1.4646	.276	45°	31070	71070		
1.181		1.4650	.218	45°			92100	
1.181	1.350*	1.4665	.282	44°	32239			
1.181		1.4764	.394	45°	39033	79033		
1.181		1.4803	.260	45°			92051	
1.181		1.4803	.281	45°		71854		
1.181		1.4961	.276	45°	31038	71038		
1.181		1.4961	.315	45°		79076		
1.181		1.4965	.238	45°			92102	
1.181		1.5059	.157	45°		71853		
1.181		1.5354	.276	45°		71369		
1.181		1.5354	.315	45°		79077		
1.181		1.5354	.354	45°		71179		
1.181		1.5748	.374	45°		71181		
1.181		1.5953	.394	45°			92035	
1.181		1.6142	.394	45°	39044	79044		
1.181		1.7520	.394	45°	39056	79056		
1.181		1.4114	.244	45°		71399		
1.181		1.6000	.315	45°			92259	
1.183	1.362*	1.4618	.264	45°		72390		
1.183		1.5059	.254	45°	31108			
1.183		1.5248	.394	45°		71036		
1.183		1.5681	.254	45°	31104			
1.186		1.4405	.313	45°	31111	71111		
1.186		1.5657	.376	45°	31112	71112		
1.187		1.4791	.313	45°		71353		
1.187		1.6310	.450	45°	32425			
1.188		1.5000	.250	45°	31198			
1.188		1.4421	.250	45°	31402	71402		
1.188		1.4425	.219	45°	31030	71030		
1.188		1.4440	.219	45°		71159		
1.188		1.4440	.250	45°	31161	71161		
1.188		1.5043	.313	45°		71342		
1.188		1.5045	.313	45°	31032			
1.188		1.5050	.218	45°	30823			
1.188		1.5050	.250	45°	30822	70822		
1.188		1.5060	.313	45°	31162	71162		
1.188		1.5680	.313	45°	30839	70839		
1.189		1.4425	.217	45°		71866		

* Special ID Features

VALVE SEAT PROGRESSIVE LISTING BY INSIDE DIAMETER

ID	ID TOP TAPER	ACTUAL OD	DEPTH	SEAT ANGLE	PART NUMBER SERIES			
					30000	70000	90000	"Killer Bee"
1.195		1.5060	.315	45°	31326			
1.195		1.5060	.360	45°	31501			
1.200		1.4440	.297	45°	30818			
1.200		1.4803	.276	45°		71400		
1.205		1.5060	.322	45°	31909			
1.210		1.5060	.345	45°	31214			
1.210	1.276	1.5070	.345	45°	31291			
1.213		1.4777	.154	45°		71305		
1.215	1.405	1.5040	.255	45°	32348			
1.215	1.344	1.5050	.219	45°	30705	70705		
1.215		1.5050	.250	45°	30722	70722		
1.215	1.275	1.5050	.280	45°	30015			
1.215		1.5050	.305	45°	30721			
1.215		1.5050	.310	45°	30716			
1.215		1.5050	.318	45°		70717		
1.219		1.4425	.219	45°	31031	71031		
1.219		1.4862	.344	45°		71864		
1.219	1.408*	1.5020	.255	33°				72405C
1.219		1.5695	.317	45°	31287	71287		
1.220		1.4138	.238	45°			92105	
1.220		1.4252	.295	45°		71121		
1.220		1.4449	.295	45°		71440		
1.220		1.4567	.394	45°	31275			
1.220		1.4630	.354	45°		71908		
1.220		1.4764	.335	45°	31071			
1.220		1.4823	.276	45°	31014			
1.220		1.4843	.315	45°	31015	71015		
1.220		1.4862	.335	45°		71387		
1.220		1.4961	.394	45°	31276	71276	91276	
1.220		1.5051	.315	45°	31073	71073		
1.220	1.405	1.5110	.275	45°	32351			
1.220		1.5157	.335	45°		71388		
1.220		1.5157	.343	45°		71368		
1.220		1.5157	.394	45°	39036	79036		
1.220		1.5209	.285	45°		71432		
1.220		1.5256	.335	45°		71389		
1.220		1.5354	.335	45°		71180		
1.220	1.356	1.5695	.344	45°	31292			
1.220		1.6142	.335	45°		71182		
1.220		1.6535	.394	45°	39047	79047		
1.221		1.5335	.335	45°	31016	71016		
1.228		1.4764	.274	45°		72341		
1.230		1.4440	.250	45°	31067			
1.230		1.5060	.278	45°	31244			
1.230		1.5690	.310	45°	31078			
1.236		1.4764	.335	45°		71858		
1.238	1.380	1.4852	.315	45°	32346			
1.240		1.4750	.227	0°	31044	71044		
1.240		1.4764	.335	45°		71386		
1.240		1.5400	.275	45°		72126		
1.240		1.5157	.295	45°			92263	
1.243		1.5700	.354	45°	31318			
1.246		1.5059	.254	45°	31109	71109		
1.246	1.546*	1.6565	.375	55°	31478			
1.250		1.4440	.219	45°	30556	70556		
1.250		1.4440	.313	45°	31160	71160		
1.250	1.372	1.4724	.310	45°		72420		

* Special ID Features

VALVE SEAT PROGRESSIVE LISTING BY INSIDE DIAMETER

ID	ID TOP TAPER	ACTUAL OD	DEPTH	SEAT ANGLE	PART NUMBER SERIES			
					30000	70000	90000	"Killer Bee"
1.250		1.5043	.281	45°		71343		
1.250		1.5050	.188	45°		70710		
1.250		1.5050	.219	45°	30711	70711		
1.250	1.390	1.5050	.240	45°	30024			
1.250		1.5050	.250	45°	30712	70712		
1.250		1.5050	.313	45°	30714	70714		
1.250		1.5050	.375	45°	30715			
1.250		1.5260	.250	45°		71840		
1.250		1.5285	.265	45°	31992			
1.250		1.5669	.313	45°		71344		
1.250		1.5670	.188	45°	31870	71870		
1.250		1.5673	.253	45°	31077			
1.250		1.5680	.219	45°	30640	70640		
1.250		1.5680	.250	45°	30645	70645		
1.250		1.5680	.281	45°	30740	70740		
1.250	1.450*	1.5680	.281	35°	32409			
1.250		1.5680	.313	45°	30647	70647		
1.250		1.5680	.343	45°	32113			
1.250		1.5890	.250	45°		71904		
1.250		1.6090	.250	45°		71905		
1.250		1.6300	.219	45°	30661	70661		
1.250		1.6300	.250	45°	30662	70662		
1.250		1.6300	.313	45°	30663	70663		
1.250		1.6300	.375	45°	30853	70853		
1.250		1.6320	.312	45°	31332			
1.250		1.6950	.375	45°		71701+5		
1.250		1.7550	.250	45°		71128		
1.255		1.5365	.359	45°		71671		
1.255	1.372	1.5685	.319	45°	31199	71199		
1.260		1.4571	.240	45°	32001			
1.260		1.4830	.350	45°	32174			
1.260		1.4850	.237	45°	30738			
1.260		1.5161	.250	45°			92104	
1.260		1.5354	.394	45°	39037	79037	99037	
1.260		1.5472	.315	45°	31075	71075		
1.260		1.5551	.394	45°	39039	79039		
1.260		1.5748	.394	45°	39040	79040		
1.260		1.5945	.394	45°	39042	79042		
1.260		1.6142	.315	45°		79079		
1.260		1.6142	.413	45°		72271		
1.260	1.340	1.6340	.394	45°	31323			
1.260		1.6535	.374	45°	31183	71183		
1.260		1.6929	.394	45°	39050	79050		
1.265	1.320	1.5695	.280	45°	31286			
1.272		1.5649	.256	45°		72009		
1.273		1.5000	.180	60°	32280			
1.280		1.5059	.295	45°		71419		
1.280		1.7362	.315	45°			92260	
1.280	1.500*	1.6500	.350	45°	32076	72076		
1.280		1.7200	.350	45°	32356			
1.281	1.398*	1.5555	.236	30°		72374		
1.282		1.6000	.299	45°		71371		
1.287		1.4803	.283	45°		71379		
1.298		1.6310	.317	45°	31218			
1.298	1.422	1.6320	.317	45°	31236			
1.299		1.5354	.315	45°		71370		
1.299		1.5551	.335	45°	31076	71076		

* Special ID Features

VALVE SEAT PROGRESSIVE LISTING BY INSIDE DIAMETER

ID	ID TOP TAPER	ACTUAL OD	DEPTH	SEAT ANGLE	PART NUMBER SERIES			
					30000	70000	90000	"Killer Bee"
1.299		1.5630	.339	45°		71422		
1.299		1.5630	.354	45°		71442		
1.299		1.5650	.335	45°		71802		
1.299		1.5748	.315	45°		79078		
1.299		1.5803	.315	45°			92434	
1.299		1.6142	.394	45°	39043	79043	99043	
1.299		1.6339	.394	45°	39045	79045	99045	
1.299		1.6535	.315	45°		79080		
1.299		1.6535	.335	45°		71184		
1.299		1.6535	.374	45°		71931		
1.299		1.6591	.315	45°			92435	
1.299		1.6929	.335	45°	31186	71186	91186	
1.299		1.7323	.394	45°	39053	79053	99053	
1.300		1.5400	.315	45°	32133			
1.300	1.385*	1.5555	.189	45°		72375		
1.300		1.6000	.409	45°	32072			
1.300		1.6470	.325	45°		72129		
1.300		1.6940	.360	45°	31083			
1.310	1.428	1.6050	.250	45°	32189	72189		
1.312	1.390	1.5680	.219	45°	30541	70541		
1.312		1.5680	.219	45°	30643	70643	90643	30643C
1.312	1.390	1.5680	.250	45°	30503	70503		
1.312		1.5680	.250	45°	30644	70644		
1.312		1.5680	.313	45°	30731			
1.312		1.5730	.219	45°	30643+5	70643+5		
1.312		1.6460	.350	45°	31226			
1.312		1.6570	.395	45°		71697		
1.312		1.6920	.219	45°	30674	70674		
1.312		1.6920	.250	45°	30675	70675		
1.312		1.6920	.313	45°	30676	70676		
1.312		1.6920	.375	45°	31270			
1.312		1.6921	.315	45°		71374		
1.312		1.7550	.395	45°	31232			
1.313		1.5669	.177	45°		71851		
1.313		1.5680	.188	45°	30840	70840		
1.313		1.5680	.219	30°		70838		
1.313		1.5680	.280	45°		71267		
1.313		1.5780	.250	45°	30644+10			
1.313		1.6090	.219	45°		71841		
1.313		1.6090	.414	45°		72148		
1.313		1.6250	.250	45°	31196			
1.313		1.6300	.219	45°	30649	70649	90649	
1.313		1.6300	.250	45°	30650	70650		
1.313		1.6300	.281	45°	31488	71488		
1.313		1.6300	.313	45°	30651	70651		
1.313		1.6300	.395	45°	30854	70854		
1.313		1.6535	.250	45°		71852		
1.313		1.6560	.375	45°	31272			
1.313		1.7140	.313	45°		71503		
1.313		1.7550	.250	45°	30889			
1.313		1.7560	.313	45°		71165		
1.319		1.5591	.374	45°	31295			
1.319		1.5748	.354	45°	31296			
1.319		1.5827	.374	45°	31278			
1.319		1.5953	.394	45°			92052	
1.319		1.6220	.260	45°		71437		
1.319		1.6260	.236	45°			92049	

* Special ID Features

VALVE SEAT PROGRESSIVE LISTING BY INSIDE DIAMETER

ID	ID TOP TAPER	ACTUAL OD	DEPTH	SEAT ANGLE	PART NUMBER SERIES			
					30000	70000	90000	"Killer Bee"
1.319		1.6260	.413	45°		72270		
1.319		1.6346	.394	45°			92384	
1.319		1.6614	.413	45°	31082	71082		
1.320		1.6260	.375	45°		71372		
1.320		1.6310	.300	45°	31223			
1.321	1.549*	1.6300	.393	60°		72224		
1.322	*	1.6020	.276	36.3°				72432C
1.322		1.6245	.375	45°		70855		
1.323	1.580*	1.6300	.240	45°	32213			
1.327		1.5410	.256	45°		71416		
1.329		1.6320	.280	45°	30860	70860		
1.333		1.6320	.237	45°	31690			
1.334		1.6300	.313	45°		70642		
1.335		1.7333	.372	45°	31110			
1.338		1.6535	.394	45°	39046	79046		
1.338		1.6732	.394	45°	39048	79048		
1.339		1.5827	.295	45°		71017		
1.339		1.5984	.276	45°		71018		
1.339		1.6142	.295	45°	31039	71039		
1.339		1.6386	.315	45°	31019	71019		
1.339		1.6417	.250	45°		71020		
1.339		1.6694	.177	45°	31308			
1.339		1.6929	.325	45°		71185		
1.339		1.7323	.374	45°	31187	71187		
1.339		1.7717	.472	45°	39058	79058	99058	
1.339		1.8110	.472	45°	39061	79061		
1.340		1.6500	.350	45°	32069			
1.340		1.6500	.425	45°	32138			
1.344		1.5670	.219	45°	31033			
1.344		1.6220	.197	45°		71946		
1.344		1.6300	.250	45°	31489	71489		
1.344		1.6310	.313	45°	31164	71164		
1.344		1.6925	.313	45°	30559	70559		
1.345	1.444	1.6000	.400	45°	32089			
1.348	1.524	1.6285	.365	45°		71924		
1.348		1.6300	.218	45°	30857			
1.350	1.626*	1.6560	.375	45°	31279			
1.350		1.6700	.375	45°				22194C
1.350		1.6929	.315	45°		71406		
1.358		1.7220	.265	45°	31709	71709	91709	
1.358		1.7717	.394	45°		71227		
1.358		1.5846	.287	45°		71418		
1.359	1.500*	1.6289	.250	30°		72305		
1.360	1.565*	1.7210	.264	45°		72218		
1.365	1.487	1.6535	.250	40°		72343		
1.366		1.5413	.232	45°		71426		
1.367		1.6500	.380	45°	32187			
1.368		1.5827	.272	45°		71803		
1.370		1.6900	.500	R.125				22264C
1.372	1.429	1.6690	.272	37°	30868			
1.372	1.492	1.6920	.281	53°		71960		
1.374		1.6201	.256	45°		71413		
1.375		1.5680	.218	45°	30841			
1.375		1.6300	.219	45°	30648	70648		
1.375		1.6300	.250	45°	30646	70646		
1.375		1.6300	.313	45°	30732	70732		
1.375		1.6310	.188	45°	31046	71046		

* Special ID Features

VALVE SEAT PROGRESSIVE LISTING BY INSIDE DIAMETER

ID	ID TOP TAPER	ACTUAL OD	DEPTH	SEAT ANGLE	PART NUMBER SERIES			
					30000	70000	90000	"Killer Bee"
1.375		1.6344	.256	45°	32287			
1.375		1.6350	.219	45°	30648+5			
1.375		1.6450	.250	45°	30864	70864		
1.375		1.6920	.188	45°	31042			
1.375		1.6920	.219	45°	30677	70677		
1.375		1.6920	.250	45°	30678	70678		
1.375		1.6920	.313	45°	30679	70679		
1.375		1.6920	.375	45°	30871	70871		
1.375		1.6945	.295	45°	31707	71707		
1.375	*	1.7500	.550	-				32233C
1.375		1.7550	.219	45°	30652	70652		
1.375		1.7550	.250	45°	30653	70653		
1.375		1.7550	.313	45°	30654	70654		
1.375		1.7570	.375	45°	31129	71129		
1.375		1.7570	.450	45°	31900			
1.375	1.610*	1.8045	.375	45°	31825			
1.375		1.8170	.313	45°		70903		
1.375		1.8190	.450	45°	32426			
1.378		1.6339	.315	45°			92074	
1.378		1.6634	.315	45°		71421		
1.378		1.6929	.315	45°		79081		
1.378		1.6929	.394	45°	39049	79049		
1.378		1.7126	.394	45°	39051	79051		
1.378		1.7559	.295	45°		71381		
1.380	1.717*	1.7570	.400	58°				22199C
1.384		1.7059	.250	45°		71085		
1.384		1.7059	.354	45°	31084	71084		
1.385		1.6929	.315	45°		71391		
1.385	1.520	1.6940	.305	45°	30190			
1.385	1.559	1.7570	.380	45°		70127		
1.390	1.489	1.6500	.400	45°	32091			
1.390	1.480	1.6945	.305	45°	31288			
1.392		1.8150	.297	45°		71376		
1.394		1.6937	.305	45°	31856			
1.394		1.7035	.315	45°	31857			
1.398		1.6023	.315	45°			92124	
1.398		1.6201	.256	45°		71813		
1.398		1.6299	.197	45°	31859			
1.398		1.6614	.315	45°		71810		
1.398		1.6811	.335	45°	31811	71811		
1.398		1.7374	.274	45°		72342		
1.398		1.8110	.394	45°		71188		
1.400	1.566	1.6500	.375	45°	32088			
1.405		1.8190	.315	45°	31137	71137		
1.406		1.6300	.250	45°	31482			
1.406		1.6450	.187	45°		71996		
1.406		1.6920	.250	45°	30670	70670		
1.406		1.6925	.313	45°	31490			
1.406		1.7863	.288	45°	31087	71087		
1.408	1.580*	1.6500	.375	45°	31979			
1.409		1.7874	.297	45°		71427		
1.410		1.6875	.365	20°			91828	
1.410	1.560	1.7570	.315	45°	30165			
1.412		1.6600	.256	45°		72178		
1.414		1.8180	.334	45°		71954		
1.417		1.6772	.315	45°		71373		
1.417		1.7028	.315	45°	31021	71021		

* Special ID Features

VALVE SEAT PROGRESSIVE LISTING BY INSIDE DIAMETER

ID	ID TOP TAPER	ACTUAL OD	DEPTH	SEAT ANGLE	PART NUMBER SERIES			
					30000	70000	90000	"Killer Bee"
1.417		1.7323	.276	45°		71375		
1.417		1.7323	.315	45°		79082		
1.417		1.7323	.394	45°	39052			
1.417		1.7327	.238	45°			92101	
1.417		1.7374	.354	45°		72215		
1.417		1.7520	.394	45°	39071	79071		
1.417		1.7520	.433	45°	39055	79055		
1.417		1.7717	.315	45°		79083		
1.417		1.8060	.292	45°			91933	
1.417		1.8504	.472	45°	39065	79065	99065	
1.417	1.668*	1.8898	.360	35°			92391	
1.417		1.8898	.335	45°			92261	
1.418		1.7969	.390	45°	31088	71088		
1.419	1.598*	1.6980	.264	45°		72389		
1.433		1.7725	.270	45°		72416		
1.435	1.505	1.8200	.314	45°	31319			
1.435		1.8740	.382	45°		71378		
1.437		1.6370	.350	45°	32173			
1.437	1.625*	1.6930	.250	30°		71947		
1.437		1.7524	.157	45°	31862			
1.437		1.7550	.375	45°	32350			
1.437		1.7560	.302	45°		71221		
1.437		1.8303	.375	45°	31090	71090		
1.437		1.8504	.394	45°	31228	71228		
1.437		1.8810	.450	45°	32427			
1.438		1.5980	.188	45°		72393		
1.438		1.6100	.188	45°		72394		
1.438		1.6920	.156	45°	30872			
1.438		1.6920	.188	45°	30873	70873		
1.438		1.6920	.219	45°	30664	70664		
1.438		1.6920	.250	45°	30673	70673		
1.438		1.6920	.313	45°	30733	70733		
1.438		1.6970	.219	45°		70664+5		
1.438		1.7550	.219	45°	30655	70655		
1.438		1.7550	.250	45°	30656	70656		
1.438	1.500	1.7550	.302	45°	31117			
1.438		1.7550	.313	45°	30657	70657		
1.438	1.500	1.7560	.188	45°	31045			
1.438		1.8170	.313	45°	30905	70905		
1.438		1.8175	.375	45°	31459			
1.438		1.8180	.219	45°	31269	71269		
1.438		1.8180	.250	45°	30904			
1.438		1.8180	.312	45°	32111			
1.440		1.7913	.374	45°		71801		
1.440	1.508	1.8190	.316	45°	31327			
1.440	1.515	1.8195	.315	45°	31284			
1.445	1.617	1.7560	.310	45°	31215			
1.450		1.6940	.297	45°	30881			
1.450		1.8120	.197	30°	31843			
1.455	1.620	1.7330	.365	45°		71925		
1.457		1.7205	.335	45°		71814		
1.457	1.457*	1.7320	.365	R.212		72242		
1.457		1.7421	.315	45°	31086	71086		
1.457		1.7425	.250	45°			92103	
1.457		1.7570	.312	45°	31317			
1.457		1.7618	.335	45°		71392		
1.457		1.7717	.335	45°		71393		

* Special ID Features

VALVE SEAT PROGRESSIVE LISTING BY INSIDE DIAMETER

ID	ID TOP TAPER	ACTUAL OD	DEPTH	SEAT ANGLE	PART NUMBER SERIES			
					30000	70000	90000	"Killer Bee"
1.457		1.7717	.472	45°	39057	79057	99057	
1.457		1.7913	.472	45°	39059	79059		
1.457		1.8567	.339	45°		71339		
1.457		1.8898	.472	45°	39069	79069		
1.457		1.8976	.284	45°		72221		
1.468		1.7550	.220	45°	32273			
1.468		1.7550	.312	45°	32109			
1.468		1.7570	.276	45°	31715			
1.468		1.8180	.313	45°	30680	70680	90680	
1.469		1.6831	.295	45°		71390		
1.469		1.7840	.290	45°		71230		
1.476		1.7559	.281	45°	31863			
1.476		1.7810	.311	45°		71257	91257	
1.476		1.8890	.394	45°		71189		
1.476		1.8900	.434	45°	31894			
1.480	1.642*	1.7421	.282	44°	32240			
1.484		1.8170	.250	45°	31089			
1.487		1.7420	.268	45°	31907			
1.490	1.600	1.8190	.305	45°	30030			
1.496		1.7815	.315	45°		71404		
1.496		1.8110	.315	45°		79084		
1.496		1.8110	.472	45°	39060	79060		
1.496		1.8190	.157	45°	31307			
1.496		1.8307	.472	45°	39062	79062		
1.496		1.8358	.285	45°	31433	71433		
1.496		1.8898	.433	45°	39068	79068		
1.499	1.619*	1.8540	.273	60°		72217		
1.500		1.7550	.219	45°	30658	70658		
1.500		1.7550	.250	45°	30659	70659	90659	20659C
1.500		1.7550	.313	45°		70660		
1.500		1.7863	.288	45°		72002		
1.500		1.8170	.375	45°	31131	71131		
1.500		1.8179	.256	45°	32008			
1.500	1.625	1.8180	.219	45°	30530	70530		
1.500		1.8180	.219	45°	30668	70668		
1.500		1.8180	.250	45°	30672	70672		
1.500		1.8180	.281	45°	30741			
1.500		1.8180	.312	45°	30907	70907	90907	20907C
1.500	1.555	1.8195	.278	45°	31285			
1.500		1.8500	.281	60°			92373	
1.500		1.8530	.273	30°	31734	71734		
1.500	*	1.8535	.272	30°		72364		
1.500		1.8550	.281	60°			92373+5	
1.500		1.8600	.281	60°			92373+10	
1.500		1.8700	.281	60°			92373+20	
1.500		1.8800	.250	45°	30919	70919		
1.500		1.8800	.375	45°	31091	71091		31091C
1.500		1.8810	.313	45°	30920	70920		
1.500		1.9440	.313	45°	31166	71166		
1.500		1.9450	.450	45°	31898			
1.500		1.9685	.335	45°			92282	
1.505		1.8161	.280	45°		71355		
1.505	1.689	1.8820	.380	45°		70138		
1.511		1.7648	.265	45°	31994			
1.514	1.680*	1.7856	.275	R.159	32327			
1.516		1.9290	.434	45°	31895			
1.516		1.9291	.394	45°		71190		

* Special ID Features

VALVE SEAT PROGRESSIVE LISTING BY INSIDE DIAMETER

ID	ID TOP TAPER	ACTUAL OD	DEPTH	SEAT ANGLE	PART NUMBER SERIES			
					30000	70000	90000	"Killer Bee"
1.520		1.8180	.177	45°		71961		
1.520		1.8180	.300	45°	31910			
1.520		1.8180	.334	45°		71951		
1.535		1.7815	.295	45°		71472		
1.535	1.731*	1.8100	.364	30°		72392		
1.535		1.8504	.472	45°	39063			
1.535		1.8661	.315	45°		71377		
1.535		1.8701	.472	45°	39066	79066		
1.535		1.9685	.394	45°		71192		
1.540	1.650*	1.8120	.365	30°		72359		
1.540		1.8125	.365	60°	31827		91827	
1.540		1.8170	.365	30°	31726			
1.562	1.655	1.8170	.365	45°		70542		
1.562	1.740	1.8800	.187	45°		71930		
1.562		1.8800	.250	45°	30509	70509		
1.562		1.8800	.312	45°	30923	70923		
1.562		2.0600	.450	45°	32208			
1.563		1.8180	.219	45°	30667	70667		
1.563		1.8180	.250	45°	30671	70671		
1.563		1.8180	.280	45°	32379			
1.563		1.8180	.313	45°	31000	71000		
1.563		1.8800	.438	30°		71739		
1.563		1.8810	.219	45°	31238	71238		
1.563		1.9420	.375	45°	32115			
1.563		1.9430	.219	45°	30933	70933		
1.563		1.9430	.250	45°	30932	70932		
1.563		1.9430	.313	45°		71496		
1.565	1.725*	1.8785	.438	30°		72307		
1.567	1.714*	1.8134	.282	44°	32238			
1.570		1.8195	.284	60°		72011		
1.570	1.660*	1.8203	.282	30°		72306		
1.570	1.711*	1.8545	.249	45°		72376		
1.573		1.9435	.379	45°	31281			
1.575		1.8307	.276	45°			92050	
1.575		1.8810	.317	45°	31217			
1.575		1.8819	.315	45°		71394		
1.575	1.692	1.8820	.317	45°	31034	71034		
1.575		1.8820	.320	45°	31316			
1.575		1.8898	.472	45°	39067	79067		
1.575		1.8917	.315	45°		71913		
1.575		2.0079	.217	45°		71415		
1.575		2.0079	.413	45°		71193		
1.575		2.0508	.364	45°		71816		
1.576	1.788*	1.8545	.230	45°		72232		
1.580		2.0000	.375	45°	32163			
1.593	1.790	2.0000	.375	45°	32358			
1.594		1.7560	.278	45°	31209			
1.594		1.8800	.375	45°	32119			
1.594		1.8810	.250	45°	30687	70687		
1.594		1.8810	.313	45°	30688	70688		
1.594		1.8810	.375	45°			92026	
1.594		2.0180	.281	45°		71765		
1.597	1.597*	1.9620	.365	R.178		72241		
1.600		1.8820	.252	45°	31092	71092		
1.600	1.870*	2.0000	.375	45°	32078			
1.600		2.0060	.375	45°		71988		
1.602		2.0005	.377	45°	32017	72017		22017C

* Special ID Features

VALVE SEAT PROGRESSIVE LISTING BY INSIDE DIAMETER

ID	ID TOP TAPER	ACTUAL OD	DEPTH	SEAT ANGLE	PART NUMBER SERIES			
					30000	70000	90000	"Killer Bee"
1.614		1.9685	.315	45°		72065		
1.614		2.0472	.413	45°	31194	71194		
1.620		1.7800	.188	45°		72395		
1.625		1.8175	.219	45°	31283			
1.625	1.775	1.8800	.219	45°		71955		
1.625		1.8810	.219	45°	30681	70681		
1.625		1.8810	.250	45°	30682	70682		
1.625		1.8810	.281	45°	30683			
1.625		1.8810	.313	45°	30684	70684		
1.625		1.8810	.453	45°		70686		
1.625		1.9120	.281	45°	31746	71746		
1.625		1.9430	.250	45°	31497	71497		
1.625		1.9430	.281	45°	31749			
1.625		1.9430	.312	45°	31134	71134		
1.625		1.9430	.375	45°	31471			
1.625		1.9435	.219	45°	31262			
1.625		1.9600	.375	45°				22252C
1.625		2.0060	.219	45°	30723			
1.625		2.0060	.250	45°	30724	70724		
1.625		2.0060	.281	45°	30725		90725	
1.625		2.0060	.297	45°		70726		
1.625		2.0060	.313	45°	30727	70727		
1.625		2.0060	.344	45°	30728			
1.625		2.0060	.375	45°	30729	70729		
1.625		2.0060	.438	45°	30730			
1.625		2.0110	.281	45°			90725+5	
1.625		2.0160	.281	45°			90725+10	
1.625		2.0260	.281	45°			90725+20	
1.625		2.0360	.281	45°			90725+30	
1.630		2.0060	.280	0°	31829		91829	
1.630		2.0110	.280	0°			91829+5	
1.634		1.9232	.177	45°	31860			
1.635		1.8560	.280	45°		71268		
1.652	1.978*	2.1360	.310	52°		72171		
1.654		1.9291	.315	45°		71191		
1.654		2.0866	.413	45°	31195	71195	91195	
1.655		1.9600	.375	45°				32366C
1.665		1.9570	.280	45°	32196			
1.665	1.837	2.0000	.375	60°	32237			
1.670		2.0150	.282	0°			91959	
1.687		2.0680	.450	45°	32428			
1.688		2.0680	.281	45°	31768	71768		
1.688		1.9430	.188	45°	30935			
1.688		1.9430	.219	45°	30936			
1.688		1.9430	.281	45°	32378			
1.688		1.9440	.250	45°	30560	70560		
1.688		2.0035	.438	45°	31758			
1.688		2.0060	.188	45°		72344		
1.688		2.0060	.219	45°	30698	70698		
1.688	1.900*	2.0060	.219	30°	31957	71957		
1.688		2.0060	.250	45°	30699	70699		
1.688		2.0060	.282	45°	30700	70700		
1.688	1.949*	2.0060	.282	35°	32408			
1.688		2.0060	.313	45°	30701			
1.688		2.0060	.375	45°	30702			
1.688		2.0060	.438	45°	30703			
1.690	*	2.0030	.280	30°			92362	

* Special ID Features

VALVE SEAT PROGRESSIVE LISTING BY INSIDE DIAMETER

ID	ID TOP TAPER	ACTUAL OD	DEPTH	SEAT ANGLE	PART NUMBER SERIES			
					30000	70000	90000	"Killer Bee"
1.690		2.1320	.450	45°	31897			
1.691	1.860*	1.9510	.262	R.187	32324			
1.692		2.0880	.299	45°	31771			
1.693		1.9685	.295	45°		72040	92040	
1.693		1.9728	.394	45°		72331		
1.693		1.9807	.402	45°		72332		
1.693		1.9886	.409	45°		72333		
1.693		2.0673	.354	45°	31401	71401		
1.693	1.929	2.0905	.327	20°			92400	
1.693	1.990	2.0906	.303	70°				17846C
1.693		2.0906	.354	45°		71430		
1.693	1.990	2.0906	.374	70°		72031		
1.693		2.0906	.394	45°	31424	71424		
1.693		2.0933	.354	45°		72382		
1.693		2.0945	.276	45°			97999	
1.693		2.1102	.354	45°		71447		
1.693		2.1102	.394	45°		71441		
1.693		2.1140	.394	45°			92399	
1.693		2.1339	.339	45°		71338	91338	
1.693		2.1340	.394	45°		72216		
1.694		1.9800	.250	45°	30297			
1.695		1.9550	.270	45°	32396			
1.697		2.0902	.382	45°	31475			
1.697		2.1098	.402	45°	31093	71093		
1.700	*	2.0080	.280	30°		72363		
1.700		2.1370	.400	45°		71504		
1.703		1.9181	.197	45°	31945			
1.705	1.978*	2.1360	.295	60°		72172		
1.712		2.0010	.385	30°	31756	71756		
1.712		2.0110	.385	30°	31756+10			
1.720		2.1516	.394	45°			92402	
1.720	1.863	2.2000	.312	45°	32093			
1.726		2.0276	.217	45°	31341			
1.730	1.906	2.0006	.264	49°		72401		
1.732		2.0441	.406	45°	32034		92034	
1.732		2.0835	.406	45°			92383	
1.732		2.1654	.472	45°	31141	71141		
1.732		2.1700	.433	45°		71783+5		
1.745	1.844	2.0000	.400	45°	32090			
1.748	2.026*	2.0675	.392	45°		72223		
1.750		2.0060	.188	45°	30690	70690		
1.750		2.0060	.219	45°	30691	70691		
1.750	1.880	2.0060	.219	45°		72298		
1.750		2.0060	.250	45°	30692	70692		
1.750		2.0060	.313	45°	30694			
1.750		2.0500	.270	45°	32397			
1.750		2.0669	.413	45°		72269		
1.750		2.0680	.281	45°	31769			
1.750		2.0685	.219	45°	31249	71249		
1.750		2.0695	.420	45°		72424		
1.750		2.1305	.219	45°		71777		
1.750		2.1305	.250	45°		71776		
1.750		2.1600	.350	45°		72347		
1.750		2.1600	.375	45°			92022	
1.750		2.1640	.450	45°	32209			
1.751		2.1701	.336	80°	32041			
1.751		2.1701	.336	80°		72044		

* Special ID Features

VALVE SEAT PROGRESSIVE LISTING BY INSIDE DIAMETER

ID	ID TOP TAPER	ACTUAL OD	DEPTH	SEAT ANGLE	PART NUMBER SERIES			
					30000	70000	90000	"Killer Bee"
1.752		2.0709	.236	45°			92048	
1.752		2.1339	.287	45°		71417		
1.765	1.809	2.0485	.250	45°	32188			
1.765		2.1050	.375	45°	31310			
1.770	2.016*	2.0680	.250	45°	32212			
1.771	1.928*	2.0485	.339	30°		72361		
1.772		2.0270	.177	45°	32004	72004		
1.781		2.0485	.344	30°	31766			
1.800		2.1250	.437	45°			92186	
1.800		2.1700	.375	45°	32354			
1.800		2.1940	.450	45°	32429			
1.810		2.1310	.375	45°		71990		
1.812		2.0680	.250	45°	30963	70963		
1.812		2.1200	.375	45°	31454			
1.812	2.030	2.1300	.250	45°	30557	70557		
1.812		2.1300	.437	45°	32139		92139	
1.812		2.1400	.375	45°	31830			
1.812		2.1940	.250	45°	31135			
1.812		2.1940	.375	45°		72276		
1.813		2.0680	.188	45°		71770		
1.813		2.1305	.188	45°	31779		91779	
1.813		2.0050	.219	45°	30952	70952		
1.813	1.875	2.0680	.250	45°	30964			
1.813		2.1300	.313	45°	31124			
1.813		2.1310	.219	45°	31240	71240		
1.818		2.1000	.431	45°	32071			
1.820	*	2.1856	.338	36.8°		72431		
1.820		2.2555	.375	45°				31949C
1.830	1.983	2.2000	.312	45°	32087			
1.850		2.2500	.320	45°				22193C
1.870		2.2560	.450	45°	32430			
1.875		2.1300	.219	45°	30974			
1.875		2.1300	.250	45°	30537	70537		
1.875		2.1925	.375	45°	32349			
1.875		2.1935	.281	45°	30984	70984		
1.875		2.2550	.375	45°	31787	71787		
1.875		2.2555	.313	45°		71470		
1.890		2.4094	.354	45°				17904C
1.904		2.3800	.375	45°				22228C
1.906		2.1300	.177	45°	32003			
1.906		2.1300	.234	45°		71473		
1.906		2.1305	.250	45°	31498	71498		
1.927	2.140*	2.3810	.319	30°		72360		
1.937		2.1930	.250	45°	31282			
1.937		2.3120	.220	45°	32272			
1.937		2.3120	.312	45°	32108			
1.938		2.2555	.188	45°	30989	70989		
1.938		2.2560	.219	45°		71261		
1.938		2.2560	.375	45°	31983			
1.947	2.120	2.2500	.312	45°	32357			
1.956	2.287*	2.4074	.284	30°				17563C
1.960		2.2560	.250	60°			92156	
1.960		2.2590	.250	45°		71995		
1.960	2.135*	2.2590	.250	45°		72246		
1.970	2.290*	2.3500	.375	53°	31456			
1.970		2.3500	.375	45°	31981			
2.000		2.3180	.250	45°	30991	70991	90991	

* Special ID Features

VALVE SEAT PROGRESSIVE LISTING BY INSIDE DIAMETER

ID	ID TOP TAPER	ACTUAL OD	DEPTH	SEAT ANGLE	PART NUMBER SERIES			
					30000	70000	90000	"Killer Bee"
2.000		2.3180	.375	45°	32118			
2.000		2.3819	.394	45°		71815		
2.000		2.4505	.377	45°				22018C
2.008		2.3665	.350	45°		72328		
2.008		2.3744	.358	45°		72329		
2.008		2.3823	.366	45°		72330		
2.011		2.3657	.350	45°	31476			
2.030		2.3810	.323	60°	31845			
2.040		2.4600	.375	45°				22365C
2.040		2.5000	.375	45°				22251C
2.125		2.4430	.375	45°	32370			

* Special ID Features

VALVE SEAT TECHNOLOGY HAS CHANGED

GM is equipping the LS3 heads with high tech sintered copper-infiltrated valve seats. High-Performance European engines like BMW and Mercedes also use this technology. This is a powder metal valve seat with a copper wafer that is infiltrated into the valve seat. This creates a unique product of 15% free copper in the microstructure of the seat. Allowing heat to be quickly transferred and performance greatly improved.

GOOD NEWS!

Dura-Bond has developed this technology and it is now available for the aftermarket in our "KILLER BEE" Valve Seat Line. Initially offered for the GM LS-Series engines with more applications to come.

- Offers Superior Thermal Conductivity
- Excellent Machining Characteristics
- High Thermal Expansion
- Lowest Wear – Improved Reliability/Durability
- Superior Surface Finishes
- Suitable for HD Intake and Exhaust Seats, Gas and Diesel
- Compatible with Most Valve Materials



“This is a Killer, LS3, Copper-Infiltrated exhaust valve seat.”

Lou Oniga, Powertrain Engineer - GM



Dura-Bond®
A MELLING COMPANY

Quality Camshaft Bearings Since 1947

3200 Arrowhead Dr., Carson City, NV 89706 · TEL (800) 227-8360 · FAX (775) 883-9497 · WEB www.dura-bondbearing.com

**"KILLER BEE" COPPER INFILTRATED VALVE SEAT
PROGRESSIVE LISTING BY OUTSIDE DIAMETER**

PART NUMBER SERIES				ACTUAL OD	ID	ID TOP TAPER	DEPTH	SEAT ANGLE
30000	70000	90000	"Killer Bee"					
30643	70643	90643	32130C	1.0490	0.825		.298	45°
			32210C	1.1450	0.835		.295	45°
			32182C	1.1980	0.960		.295	45°
			72419C	1.1990	0.960	1.076	.322	45°
			72405C	1.5020	1.219	1.408*	.255	33°
			30643C	1.5680	1.312		.219	45°
			72432C	1.6020	1.322	*	.276	36.3°
			22194C	1.6700	1.350		.375	45°
			22264C	1.6900	1.370		.500	R.125
			32233C	1.7500	1.375	*	.550	-
			20659C	1.7550	1.500		.250	45°
30659	70659	90659	22199C	1.7570	1.380	1.717*	.400	58°
			20907C	1.8180	1.500		.312	45°
30907	70907	90907	31091C	1.8800	1.500		.375	45°
31091	71091		22252C	1.9600	1.625		.375	45°
32017	72017		32366C	1.9600	1.655		.375	45°
			22017C	2.0005	1.602		.377	45°
			17846C	2.0906	1.693	1.990	.303	70°
			22193C	2.2500	1.850		.320	45°
			31949C	2.2555	1.820		.375	45°
			22228C	2.3800	1.904		.375	45°
			17563C	2.4074	1.956	2.287*	.284	30°
			17904C	2.4094	1.890		.354	45°
			22018C	2.4505	2.000		.377	45°
			22365C	2.4600	2.040		.375	45°
22251C	2.5000	2.040		.375	45°			

* Special ID Features

UNIVERSAL VALVE SEAT PROGRESSIVE LISTING BY OUTSIDE DIAMETER

DECIMAL

METRIC

PART NUMBER SERIES			ACTUAL	ID	DEPTH	SEAT
30000	70000	90000	OD			ANGLE

PART NUMBER SERIES			ACTUAL	ID	DEPTH	SEAT
30000	70000	90000	OD			ANGLE

39006	79006	99006	1.1024	0.866	.394	45°
39007	79007	99007	1.1220	0.866	.394	45°
39008	79008	99008	1.1417	0.906	.394	45°
39009	79009	99009	1.1614	0.906	.394	45°
39011	79011	99011	1.1811	0.787	.394	45°
39010	79010	99010	1.1811	0.906	.394	45°
39012	79012	99012	1.2008	0.906	.394	45°
39014	79014	99014	1.2205	0.827	.394	45°
39013	79013	99013	1.2205	0.945	.394	45°
39015	79015	99015	1.2402	0.945	.394	45°
39017	79017	99017	1.2598	0.866	.394	45°
39016	79016	99016	1.2598	0.984	.394	45°
39018	79018	99018	1.2795	0.984	.394	45°
39020	79020	99020	1.2992	0.906	.394	45°
39019	79019	99019	1.2992	1.023	.394	45°
39021	79021	99021	1.3189	1.023	.394	45°
39023	79023	99023	1.3386	0.945	.394	45°
39024	79024	99024	1.3583	1.063	.394	45°
39026	79026	99026	1.3780	0.984	.394	45°
39025	79025	99025	1.3780	1.102	.394	45°
39027	79027		1.3976	1.102	.394	45°
39029	79029	99029	1.4173	1.024	.394	45°
39028	79028	99028	1.4173	1.142	.394	45°
39030	79030	99030	1.4370	1.141	.394	45°
39031	79031	99031	1.4567	1.181	.394	45°
39033	79033		1.4764	1.181	.394	45°
39035	79035	99035	1.4961	1.102	.394	45°
39036	79036		1.5157	1.220	.394	45°
39038	79038		1.5354	1.141	.394	45°
39037	79037	99037	1.5354	1.260	.394	45°
39039	79039		1.5551	1.260	.394	45°
39041	79041	99041	1.5748	1.141	.394	45°
39040	79040		1.5748	1.260	.394	45°
39042	79042		1.5945	1.260	.394	45°
39044	79044		1.6142	1.181	.394	45°
39043	79043	99043	1.6142	1.299	.394	45°
39045	79045	99045	1.6339	1.299	.394	45°
39047	79047		1.6535	1.220	.394	45°
39046	79046		1.6535	1.338	.394	45°
39048	79048		1.6732	1.338	.394	45°
39050	79050		1.6929	1.260	.394	45°
39049	79049		1.6929	1.378	.394	45°
39051	79051		1.7126	1.378	.394	45°
39053	79053	99053	1.7323	1.299	.394	45°
39052			1.7323	1.417	.394	45°
39056	79056		1.7520	1.181	.394	45°
39071	79071		1.7520	1.417	.394	45°
39055	79055		1.7520	1.417	.433	45°
39058	79058	99058	1.7717	1.339	.472	45°
39057	79057	99057	1.7717	1.457	.472	45°
39059	79059		1.7913	1.457	.472	45°
39061	79061		1.8110	1.339	.472	45°
39060	79060		1.8110	1.496	.472	45°
39062	79062		1.8307	1.496	.472	45°
39065	79065	99065	1.8504	1.417	.472	45°
39063			1.8504	1.535	.472	45°
39066	79066		1.8701	1.535	.472	45°
39069	79069		1.8898	1.457	.472	45°
39068	79068		1.8898	1.496	.433	45°
39067	79067		1.8898	1.575	.472	45°

39006	79006	99006	28.00	22.00	10.00	45°
39007	79007	99007	28.50	22.00	10.00	45°
39008	79008	99008	29.00	23.00	10.00	45°
39009	79009	99009	29.50	23.00	10.00	45°
39011	79011	99011	30.00	20.00	10.00	45°
39010	79010	99010	30.00	23.00	10.00	45°
39012	79012	99012	30.50	23.00	10.00	45°
39014	79014	99014	31.00	21.00	10.00	45°
39013	79013	99013	31.00	24.00	10.00	45°
39015	79015	99015	31.50	24.00	10.00	45°
39017	79017	99017	32.00	22.00	10.00	45°
39016	79016	99016	32.00	25.00	10.00	45°
39018	79018	99018	32.50	25.00	10.00	45°
39020	79020	99020	33.00	23.00	10.00	45°
39019	79019	99019	33.00	26.00	10.00	45°
39021	79021	99021	33.50	26.00	10.00	45°
39023	79023	99023	34.00	24.00	10.00	45°
39024	79024	99024	34.50	27.00	10.00	45°
39026	79026	99026	35.00	25.00	10.00	45°
39025	79025	99025	35.00	28.00	10.00	45°
39027	79027		35.50	28.00	10.00	45°
39029	79029	99029	36.00	26.00	10.00	45°
39028	79028	99028	36.00	29.00	10.00	45°
39030	79030	99030	36.50	29.00	10.00	45°
39031	79031	99031	37.00	30.00	10.00	45°
39033	79033		37.50	30.00	10.00	45°
39035	79035	99035	38.00	28.00	10.00	45°
39036	79036		38.50	31.00	10.00	45°
39038	79038		39.00	29.00	10.00	45°
39037	79037	99037	39.00	32.00	10.00	45°
39039	79039		39.50	32.00	10.00	45°
39041	79041	99041	40.00	29.00	10.00	45°
39040	79040		40.00	32.00	10.00	45°
39042	79042		40.50	32.00	10.00	45°
39044	79044		41.00	30.00	10.00	45°
39043	79043	99043	41.00	33.00	10.00	45°
39045	79045	99045	41.50	33.00	10.00	45°
39047	79047		42.00	31.00	10.00	45°
39046	79046		42.00	34.00	10.00	45°
39048	79048		42.50	34.00	10.00	45°
39050	79050		43.00	32.00	10.00	45°
39049	79049		43.00	35.00	10.00	45°
39051	79051		43.50	35.00	10.00	45°
39053	79053	99053	44.00	33.00	10.00	45°
39052			44.00	36.00	10.00	45°
39056	79056		44.50	30.00	10.00	45°
39071	79071		44.50	36.00	10.00	45°
39055	79055		44.50	36.00	11.00	45°
39058	79058	99058	45.00	34.00	12.00	45°
39057	79057	99057	45.00	37.00	12.00	45°
39059	79059		45.50	37.00	12.00	45°
39061	79061		46.00	34.00	12.00	45°
39060	79060		46.00	38.00	12.00	45°
39062	79062		46.50	38.00	12.00	45°
39065	79065	99065	47.00	36.00	12.00	45°
39063			47.00	39.00	12.00	45°
39066	79066		47.50	39.00	12.00	45°
39069	79069		48.00	37.00	12.00	45°
39068	79068		48.00	38.00	11.00	45°
39067	79067		48.00	40.00	12.00	45°

METRIC VALVE SEAT PROGRESSIVE LISTING BY OUTSIDE DIAMETER

PART NUMBER SERIES				ACTUAL		ID TOP		SEAT
30000	70000	90000	"Killer Bee"	OD	ID	TAPER	DEPTH	ANGLE
	71357			23.50	18.0		6.0	45°
	71167			24.00	18.0		6.5	45°
	72334	92334		24.00	18.0		8.0	45°
	72066			24.25	18.0		7.0	45°
	72335	92335		25.00	19.0		8.0	45°
	71446			25.00	20.0		7.0	45°
	71346			25.10	20.0		6.0	45°
31002	71002			25.12	20.0		6.0	45°
	71349			25.15	20.0		6.0	45°
		92283		26.00	18.0		7.0	45°
	72336			26.00	20.0		8.0	45°
	71398			26.25	21.0		4.5	45°
31003	71382			26.60	21.0		6.0	45°
	71003			26.70	20.0		5.7	45°
	71395			26.80	21.0		6.2	45°
	71350			26.82	20.5		5.7	45°
		92404		27.00	20.0		8.0	45°
	72337			27.00	21.0		10.0	45°
31096				27.13	22.1		6.5	45°
	71383			27.15	20.0		6.0	45°
31047	71047			27.15	20.1		6.6	45°
		92027		27.23	21.9		7.0	45°
	71429			27.68	22.2		6.4	45°
	71804			27.90	23.0		6.5	45°
		92290		28.00	18.0		6.0	45°
	71168			28.00	20.0		8.0	45°
	71428			28.00	20.5		6.5	45°
39006	79006	99006		28.00	22.0		10.0	45°
	71396			28.15	22.0		6.5	45°
	71807			28.20	22.6		6.0	45°
	71812			28.25	22.6		6.0	45°
39007	79007	99007		28.50	22.0		10.0	45°
	72043			28.65	23.0		7.7	45°
31097				28.70	22.1		4.9	45°
31048	71048			28.75	21.0		7.2	45°
	72339			28.80	24.0		8.6	45°
		92047		28.85	23.5		5.5	45°
	72338			29.00	18.0		10.0	45°
	71169			29.00	21.0		8.5	45°
39008	79008	99008		29.00	23.0		10.0	45°
	71410	91410		29.20	23.0		6.5	45°
	71431			29.25	22.2		6.4	45°
39009	79009	99009		29.50	23.0		10.0	45°
	71358			29.62	20.5		7.1	45°
	71444			29.80	24.0		6.0	45°
39011	79011	99011		30.00	20.0		10.0	45°
31170	71170			30.00	22.0		8.5	45°
39010	79010	99010		30.00	23.0		10.0	45°
	71411			30.00	24.0		8.5	45°
	72039			30.00	26.0		9.5	45°
31049	71049			30.02	23.5		6.2	45°
		92303		30.05	23.7		5.0	45°
	71345			30.10	25.0		6.3	45°
	71004			30.12	25.0		6.3	45°
	71436			30.15	24.0		9.0	45°
	71445			30.15	25.0		5.1	45°
31005	71005			30.15	25.0		6.3	45°

CONVERSION FORMULA
 INCHES X 25.4 = MM
 MM / 25.4 = INCHES

METRIC VALVE SEAT PROGRESSIVE LISTING BY OUTSIDE DIAMETER

30000	PART NUMBER SERIES			ACTUAL	ID	ID TOP TAPER	DEPTH	SEAT ANGLE
	70000	90000	"Killer Bee"	OD				
	72279	92279		30.19	24.1		8.1	45°
	71352			30.28	22.2		6.4	45°
		92255		30.28	20.0		8.0	45°
31098				30.31	22.1		6.5	45°
	71435			30.31	23.6		6.5	45°
31099				30.31	23.7		6.5	45°
39012	79012	99012		30.50	23.0		10.0	45°
31051	71051			30.50	25.0		6.5	45°
		92033		30.64	25.1		7.0	45°
		92106		30.91	25.0		6.4	45°
		92369		31.00	18.0		7.5	45°
39014	79014	99014		31.00	21.0		10.0	45°
31171	71171			31.00	23.0		8.5	45°
39013	79013	99013		31.00	24.0		10.0	45°
	71448			31.00	25.0		6.0	45°
	71354			31.12	23.1		7.2	45°
	78000			31.14	24.0		5.2	45°
	71414			31.25	25.0		8.0	45°
		92262		31.50	24.5		8.0	45°
39015	79015	99015		31.50	24.0		10.0	45°
	72226			31.50	25.8		7.0	45°
	71434			31.51	23.9		8.5	45°
	71384			31.60	26.0		6.0	45°
	71409			31.70	26.0		6.5	45°
	72278			31.83	27.4		8.5	45°
30764	70764			31.88	25.4		6.4	45°
31052				31.88	26.8		6.4	45°
	71359			31.88	25.4		6.4	45°
31105	71105			31.90	23.7		6.5	45°
31100				31.90	25.3		6.5	45°
31054	71054			31.93	23.1		7.2	45°
		92028		31.99	26.9		7.0	45°
		92289		32.00	22.0		8.5	45°
39017	79017	99017		32.00	22.0		10.0	45°
	71172			32.00	24.0		8.5	45°
	71311	91311		32.00	24.0		9.0	45°
39016	79016	99016		32.00	25.0		10.0	45°
31808	71808			32.01	25.0		8.0	45°
		92042		32.20	23.0	26.0	6.3	45°
	71347			32.32	26.0		6.0	45°
	72301			32.33	27.4		8.5	45°
		91450		32.35	23.0	26.0	6.3	45°
39018	79018	99018		32.50	25.0		10.0	45°
		91914		32.50	27.0		5.5	45°
	71403			32.58	27.0		6.0	45°
	71800			32.60	27.5		9.0	45°
	71360			32.65	25.0		6.0	45°
31006	71006			32.65	25.5		8.0	45°
31007	71007			32.65	26.0		8.5	45°
	72340			32.80	28.5		8.8	45°
	72302			32.83	27.4		8.5	45°
	71425			33.00	23.0		8.0	45°
39020	79020	99020		33.00	23.0		10.0	45°
31173	71173			33.00	25.0		8.5	45°
39019	79019	99019		33.00	26.0		10.0	45°
	71348	91348		33.00	26.0		6.5	45°
	71008	91008		33.15	28.0		7.0	45°

CONVERSION FORMULA
 INCHES X 25.4 = MM
 MM / 25.4 = INCHES

METRIC VALVE SEAT PROGRESSIVE LISTING BY OUTSIDE DIAMETER

PART NUMBER SERIES				ACTUAL		ID TOP		SEAT
30000	70000	90000	"Killer Bee"	OD	ID	TAPER	DEPTH	ANGLE
	71123			33.20	27.5		7.0	45°
31056				33.46	25.4		6.4	45°
31101	71101			33.48	26.9		6.5	45°
39021	79021	99021		33.50	26.0		10.0	45°
31293				33.50	27.0		9.0	45°
31058				33.50	24.8		7.1	45°
	72038			33.50	26.0		8.0	45°
	70563			33.50	26.5		8.0	45°
	71397			33.60	27.5		7.3	45°
		92222		33.65	29.4		6.6	45°
31009	71009			33.70	27.0		8.0	45°
31010	71010	91010		33.70	28.6		6.4	45°
		92125		33.70	29.0		7.5	45°
	71438			33.80	28.6		6.4	45°
		92256		34.00	24.0		8.5	45°
39023	79023	99023		34.00	24.0		10.0	45°
31174	71174			34.00	26.0		8.5	45°
31273	71273	91273		34.00	27.0		10.0	45°
	71306			34.00	28.0		4.5	45°
	71385			34.10	27.5		6.0	45°
	71361			34.12	26.0		7.6	45°
		91449		34.15	28.0		6.0	45°
31060	71060			34.25	27.0		8.0	45°
	71011			34.25	28.6		6.4	45°
	71356			34.30	27.0		8.0	45°
39024	79024	99024		34.50	27.0		10.0	45°
		92075		34.50	29.0		7.5	45°
31035	71035			34.63	25.0		10.0	45°
		92032		34.64	29.6		7.0	45°
31061	71061			34.70	28.3		7.5	45°
	71809			34.80	29.0		6.5	45°
	71362			34.80	29.0		7.2	45°
39026	79026	99026		35.00	25.0		10.0	45°
	71175			35.00	26.0		9.0	45°
	71408			35.00	28.0		5.0	45°
39025	79025	99025		35.00	28.0		10.0	45°
	71363			35.06	27.8		6.4	45°
31102				35.07	26.9		6.5	45°
31103				35.07	28.5		6.5	45°
31064				35.10	25.4		7.1	45°
31063				35.10	25.4		10.4	45°
	71805			35.15	30.0		7.4	45°
31065	71065			35.25	28.0		8.0	45°
39027	79027			35.50	28.0		10.0	45°
31274	71274			35.50	29.0		10.0	45°
31294				35.50	29.5		9.5	45°
31012	71012			35.60	29.0		8.0	45°
	71423			35.70	30.0		8.6	45°
	71399			35.85	30.0		6.2	45°
		92105		35.91	31.0		6.0	45°
39029	79029	99029		36.00	26.0		10.0	45°
	71176			36.00	27.0		9.0	45°
39028	79028	99028		36.00	29.0		10.0	45°
31066	71066			36.12	29.3		8.0	45°
	71412			36.16	29.3		6.4	45°
	71121			36.20	31.0		7.5	45°
	71420			36.25	29.0		8.0	45°

CONVERSION FORMULA
 INCHES X 25.4 = MM
 MM / 25.4 = INCHES

METRIC VALVE SEAT PROGRESSIVE LISTING BY OUTSIDE DIAMETER

PART NUMBER SERIES				ACTUAL	ID	ID TOP	DEPTH	SEAT
30000	70000	90000	"Killer Bee"	OD	ID	TAPER	DEPTH	ANGLE
39030	79030	99030		36.50	29.0		10.0	45°
31111	71111			36.59	30.1		8.0	45°
	71380			36.63	28.6		6.4	45°
	71364			36.63	28.6		9.0	45°
31013	71013			36.63	28.6		8.0	45°
31402	71402			36.63	30.2		6.4	45°
30802	70802			36.64	28.6		6.4	45°
30803	70803			36.64	28.6		8.0	45°
	71407			36.65	28.7		8.0	45°
		92257		36.65	26.0		8.5	45°
31107				36.66	26.9		6.5	45°
31067				36.68	31.2		6.4	45°
	71439			36.70	29.0		8.0	45°
	71440			36.70	31.0		7.5	45°
31068	71068			37.00	28.0		9.0	45°
31069	71069			37.00	30.0		8.0	45°
39031	79031	99031		37.00	30.0		10.0	45°
31275				37.00	31.0		10.0	45°
31113				37.03	27.9		8.9	45°
	71908			37.16	31.0		9.0	45°
31070	71070			37.20	30.0		7.0	45°
		92100		37.21	30.0		5.5	45°
	71365			37.30	29.0		8.0	45°
39033	79033			37.50	30.0		10.0	45°
31071				37.50	31.0		8.5	45°
	72341			37.50	31.2		7.0	45°
	71386			37.50	31.5		8.5	45°
	71353			37.57	30.1		8.0	45°
		92051		37.60	30.0		6.6	45°
	71400			37.60	30.5		7.0	45°
	71379			37.60	32.7		7.2	45°
31014				37.65	31.0		7.0	45°
31015	71015			37.70	31.0		8.0	45°
	71387			37.75	31.0		8.5	45°
39035	79035	99035		38.00	28.0		10.0	45°
	71178			38.00	29.0		9.0	45°
31038	71038			38.00	30.0		7.0	45°
31276	71276	91276		38.00	31.0		10.0	45°
		92102		38.01	30.0		6.0	45°
31198				38.10	30.2		6.4	45°
	71366			38.12	29.2		7.2	45°
	71342			38.21	30.2		8.0	45°
	71343			38.21	31.8		7.1	45°
30708				38.23	28.6		6.4	45°
30715				38.23	31.8		9.5	45°
	71367			38.23	28.5		8.7	45°
31073	71073			38.23	31.0		8.0	45°
		92258		38.23	28.0		8.5	45°
31108				38.25	30.0		6.5	45°
31109	71109			38.25	31.6		6.5	45°
	71419			38.25	32.5		7.5	45°
31074				38.28	27.9		8.0	45°
	71388			38.50	31.0		8.5	45°
	71368			38.50	31.0		8.7	45°
39036	79036			38.50	31.0		10.0	45°
		92263		38.50	31.5		7.5	45°
		92104		38.51	32.0		6.4	45°

CONVERSION FORMULA
 INCHES X 25.4 = MM
 MM / 25.4 = INCHES

METRIC VALVE SEAT PROGRESSIVE LISTING BY OUTSIDE DIAMETER

PART NUMBER SERIES				ACTUAL		ID TOP		SEAT
30000	70000	90000	"Killer Bee"	OD	ID	TAPER	DEPTH	ANGLE
	71432			38.63	31.0		7.2	45°
	71036			38.73	30.0		10.0	45°
	71389			38.75	31.0		8.5	45°
31016	71016			38.95	31.0		8.5	45°
39038	79038			39.00	29.0		10.0	45°
	71369			39.00	30.0		7.0	45°
	71179			39.00	30.0		9.0	45°
	71180			39.00	31.0		8.5	45°
39037	79037	99037		39.00	32.0		10.0	45°
	71370			39.00	33.0		8.0	45°
	71416			39.14	33.7		6.5	45°
	71426			39.15	34.7		5.9	45°
31075	71075			39.30	32.0		8.0	45°
39039	79039			39.50	32.0		10.0	45°
31076	71076			39.50	33.0		8.5	45°
31295				39.60	33.5		9.5	45°
	71422			39.70	33.0		8.6	45°
	71442			39.70	33.0		9.0	45°
	71802			39.75	33.0		8.5	45°
31112	71112			39.77	30.1		9.6	45°
	71344			39.80	31.8		8.0	45°
31077				39.81	31.8		6.4	45°
30645	70645			39.83	31.8		6.4	45°
31104				39.83	30.0		6.5	45°
31079				39.85	30.0		7.7	45°
31078				39.85	31.2		7.9	45°
39041	79041	99041		40.00	29.0		10.0	45°
	71181			40.00	30.0		9.5	45°
39040	79040			40.00	32.0		10.0	45°
31296				40.00	33.5		9.0	45°
		92434		40.14	33.0		8.0	45°
31081	71081			40.19	30.0		10.5	45°
31278				40.20	33.5		9.5	45°
	71017			40.20	34.0		7.5	45°
	71803			40.20	34.7		6.9	45°
	71418			40.25	34.5		7.3	45°
39042	79042			40.50	32.0		10.0	45°
		92035		40.52	30.0		10.0	45°
		92052		40.52	33.5		10.0	45°
	71018			40.60	34.0		7.0	45°
		92259		40.64	30.0		8.0	45°
	71371			40.64	32.6		7.6	45°
		92124		40.70	35.5		8.0	45°
39044	79044			41.00	30.0		10.0	45°
	71182			41.00	31.0		8.5	45°
39043	79043	99043		41.00	33.0		10.0	45°
31039	71039			41.00	34.0		7.5	45°
	71413			41.15	34.9		6.5	45°
	71813			41.15	35.5		6.5	45°
	71437			41.20	33.5		6.6	45°
31196				41.28	33.4		6.4	45°
		92049		41.30	33.5		6.0	45°
	72270			41.30	33.5		10.5	45°
	71372			41.30	33.5		9.5	45°
30662	70662			41.40	31.8		6.4	45°
30853	70853			41.40	31.8		9.5	45°
39045	79045	99045		41.50	33.0		10.0	45°

CONVERSION FORMULA
 INCHES X 25.4 = MM
 MM / 25.4 = INCHES

METRIC VALVE SEAT PROGRESSIVE LISTING BY OUTSIDE DIAMETER

PART NUMBER SERIES				ACTUAL		ID TOP		SEAT
30000	70000	90000	"Killer Bee"	OD	ID	TAPER	DEPTH	ANGLE
		92074		41.50	35.0		8.0	45°
31323				41.50	32.0		10.0	45°
		92384		41.52	33.5		10.0	45°
31019	71019			41.62	34.0		8.0	45°
	71020			41.70	34.0		6.4	45°
39047	79047			42.00	31.0		10.0	45°
31183	71183			42.00	32.0		9.5	45°
	71184			42.00	33.0		8.5	45°
39046	79046			42.00	34.0		10.0	45°
		92435		42.14	33.0		8.0	45°
31082	71082			42.20	33.5		10.5	45°
	71810			42.20	35.5		8.0	45°
	71421			42.25	35.0		8.0	45°
31308				42.40	34.0		4.5	45°
39048	79048			42.50	34.0		10.0	45°
	71373			42.60	36.0		8.0	45°
31811	71811			42.70	35.5		8.5	45°
	71390			42.75	37.3		7.5	45°
30675	70675			42.98	33.3		6.4	45°
30676	70676			42.98	33.3		8.0	45°
	71374			42.98	33.3		8.0	45°
39050	79050			43.00	32.0		10.0	45°
31186	71186	91186		43.00	33.0		8.5	45°
	71406			43.00	34.3		8.0	45°
39049	79049			43.00	35.0		10.0	45°
	71391			43.00	35.2		8.0	45°
31083				43.03	33.0		9.1	45°
31021	71021			43.25	36.0		8.0	45°
	71085			43.33	35.2		6.4	45°
31084	71084			43.33	35.2		9.0	45°
39051	79051			43.50	35.0		10.0	45°
	71814			43.70	37.0		8.5	45°
39053	79053	99053		44.00	33.0		10.0	45°
31187	71187			44.00	34.0		9.5	45°
	71375			44.00	36.0		7.0	45°
39052				44.00	36.0		10.0	45°
		92101		44.01	36.0		6.0	45°
31110				44.03	33.9		9.4	45°
		92260		44.10	32.5		8.0	45°
	72342			44.13	35.5		7.0	45°
	72215			44.13	36.0		9.0	45°
31086	71086			44.25	37.0		8.0	45°
		92103		44.26	37.0		6.4	45°
39056	79056			44.50	30.0		10.0	45°
39071	79071			44.50	36.0		10.0	45°
39055	79055			44.50	36.0		11.0	45°
30653	70653			44.58	34.9		6.4	45°
30654	70654			44.58	34.9		8.0	45°
	71381			44.60	35.0		7.5	45°
	71392			44.75	37.0		8.5	45°
39058	79058	99058		45.00	34.0		12.0	45°
	71227			45.00	34.5		10.0	45°
	71393			45.00	37.0		8.5	45°
39057	79057	99057		45.00	37.0		12.0	45°
	71404			45.25	38.0		8.0	45°
	71472			45.25	39.0		7.5	45°
31087	71087			45.37	35.7		7.3	45°

CONVERSION FORMULA
 INCHES X 25.4 = MM
 MM / 25.4 = INCHES

METRIC VALVE SEAT PROGRESSIVE LISTING BY OUTSIDE DIAMETER

PART NUMBER SERIES				ACTUAL		ID TOP		SEAT
30000	70000	90000	"Killer Bee"	OD	ID	TAPER	DEPTH	ANGLE
	71427			45.40	35.8		7.5	45°
	71801			45.50	36.6		9.5	45°
39059	79059			45.50	37.0		12.0	45°
31088	71088			45.64	36.0		9.9	45°
39061	79061			46.00	34.0		12.0	45°
	71188			46.00	35.5		10.0	45°
39060	79060			46.00	38.0		12.0	45°
	71376			46.10	35.4		7.5	45°
	71355			46.13	38.2		7.1	45°
31089				46.15	37.7		6.4	45°
31307				46.20	38.0		4.0	45°
31090	71090			46.49	36.5		9.5	45°
39062	79062			46.50	38.0		12.0	45°
		92050		46.50	40.0		7.0	45°
31433	71433			46.63	38.0		7.2	45°
39065	79065	99065		47.00	36.0		12.0	45°
31228	71228			47.00	36.5		10.0	45°
39063				47.00	39.0		12.0	45°
	71339			47.16	37.0		8.6	45°
	71377			47.40	39.0		8.0	45°
39066	79066			47.50	39.0		12.0	45°
	71378			47.60	36.4		9.7	45°
30919	70919			47.75	38.1		6.4	45°
31091	71091		31091C	47.75	38.1		9.5	45°
		92026		47.78	40.5		9.5	45°
30682	70682			47.78	41.3		6.4	45°
	71394			47.80	40.0		8.0	45°
31092	71092			47.80	40.6		6.4	45°
	71189			47.98	37.5		10.0	45°
		92261		48.00	36.0		8.5	45°
39069	79069			48.00	37.0		12.0	45°
39068	79068			48.00	38.0		11.0	45°
39067	79067			48.00	40.0		12.0	45°
	71913			48.05	40.0		8.0	45°
	72221			48.20	37.0		7.2	45°
	71190			49.00	38.5		10.0	45°
	71191			49.00	42.0		8.0	45°
		92282		50.00	38.1		8.5	45°
	71192			50.00	39.0		10.0	45°
	72040	92040		50.00	43.0		7.5	45°
	72331			50.11	43.0		10.0	45°
	72332			50.31	43.0		10.2	45°
	72333			50.51	43.0		10.4	45°
30724	70724			50.95	41.3		6.4	45°
30727	70727			50.95	41.3		8.0	45°
	71415			51.00	40.0		5.5	45°
	71193			51.00	40.0		10.5	45°
32034		92034		51.92	44.0		10.3	45°
31194	71194			52.00	41.0		10.5	45°
	71816			52.09	40.0		9.2	45°
	72269			52.50	44.5		10.5	45°
31401	71401			52.51	43.0		9.0	45°
		92048		52.60	44.5		6.0	45°
		92383		52.92	44.0		10.3	45°
31195	71195	91195		53.00	42.0		10.5	45°
31475				53.09	43.1		9.7	45°
		92400		53.10	43.0	49.0	8.3	20°

CONVERSION FORMULA
 INCHES X 25.4 = MM
 MM / 25.4 = INCHES

METRIC VALVE SEAT PROGRESSIVE LISTING BY OUTSIDE DIAMETER

PART NUMBER SERIES				ACTUAL	ID	ID TOP	DEPTH	SEAT
30000	70000	90000	"Killer Bee"	OD	ID	TAPER	DEPTH	ANGLE
31424	71430			53.10	43.0	50.5	9.0	45°
	72031			53.10	43.0		9.5	70°
	71424			53.10	43.0		10.0	45°
	72382			53.17	43.0		9.0	45°
31093		97999		53.20	43.0		7.0	45°
	71093			53.59	43.1		10.2	45°
	71447			53.60	43.0		9.0	45°
	71441			53.60	43.0		10.0	45°
		92399		53.70	43.0		10.0	45°
	71338	91338		54.20	43.0		8.6	45°
	71417			54.20	44.5		7.3	45°
	72216			54.20	43.0		10.0	45°
31141		92402		54.65	43.7		10.0	45°
	71141			55.00	44.0		12.0	45°
32041	71783+5			55.12	44.0		11.0	45°
				55.12	44.5		8.5	80°
31476	72044			55.12	44.5		8.5	80°
				60.09	51.1		8.9	45°
	72328			60.11	51.0		8.9	45°
	72329			60.31	51.0		9.1	45°
	71815			60.50	50.8		10.0	45°
	72330			60.51	51.0		9.3	45°

CONVERSION FORMULA
 INCHES X 25.4 = MM
 MM / 25.4 = INCHES

Dura-Bond[®]

Valve seat inserts

Technical Information and
Installation Instructions

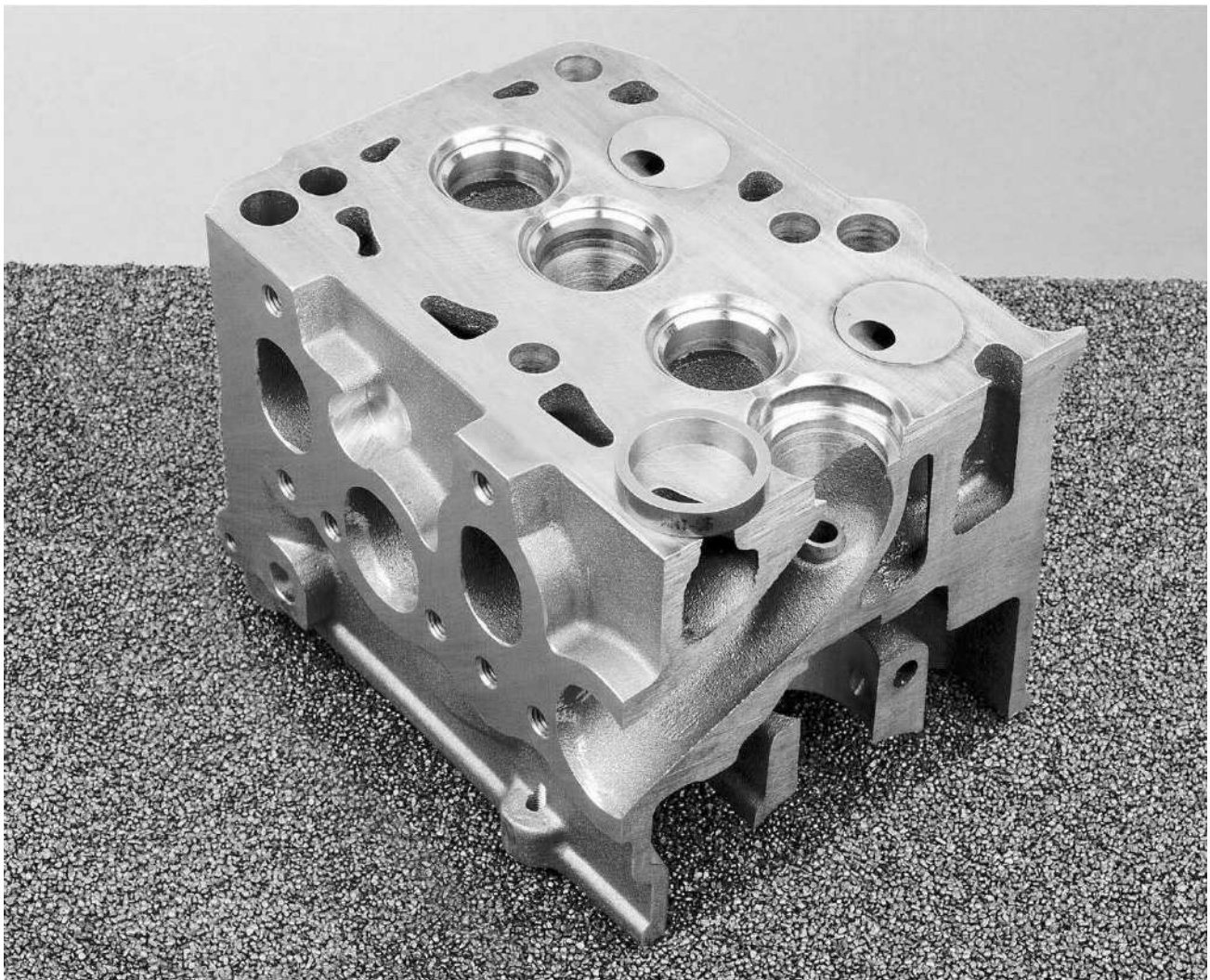

Index

Chapter 1: Introduction

- 1.1 Valve seat installation
- 1.2 Machining practices

Chapter 2: Cutting valve seat inserts and counter bores

- 2.1 Removal of valve seats and cutting of seat pocket counter bores

Chapter 3: Installation

- 3.1 Inserting the valve seats
- 3.2 Cutting the seating surface
- 3.3 Using a cutting machine
- 3.4 Using a grinding machine
- 3.5 Checking the final product

Chapter 4: Dura-Bond valve seat inserts

- 4.1 Valve seat inserts Materials
- 4.2 30000 / 70000 Series
- 4.3 Overview

Chapter 1: Introduction

1.1 Valve seat installation

Valve seat installation and refitting is only one of many operations necessary for the professional rebuilding or reconditioning of a cylinder head. Successful cylinder head remanufacturing requires that these reconditioning operations be done in the correct sequence.

Valve seat installation and refitting can only be successfully accomplished after the following operations have been completed.

- Through cleaning, inspection and any failure analysis
- Measure and record each assembled valve stem height and valve head protrusion
- Straightening of the cylinder head and milling/grinding of the firing deck and all other mating surfaces
- All valve guides must be renewed or refitted and be within original factory specifications

The cylinder head must be dimen-

sionally and geometrically within original factory specifications. The cylinder head thickness, valve guide clearances, concentricity, and perpendicularity must be correct. There should be no warping, twisting, or any type of misalignment of any part of the cylinder head.

Sometimes you may lightly touch up the valve face and valve seat mating surface without putting the valve geometry out of factory specification but most of the modern multi-valve aluminum cylinder heads will require new inserts be installed to maintain correct valve train geometry.

Only new valves or valves which have been reconditioned and are within original factory specification must be used. All valve springs must be inspected and must meet all original factory specifications or be replaced.

As it relates to valve seats, there are three types of cylinder heads:

- Cast iron cylinder heads with removable valve seat inserts
- Cast iron cylinder heads with integral hardened valve seat areas
- Aluminum cylinder heads with removable valve seat inserts

You must replace the old valve seat insert or refit the integral hardened valve seat area with a new valve seat insert if:

- The cylinder head required straightening before resurfacing.
- Any welding had to be done on the cylinder head.
- The cylinder head is aluminum and was cleaned in a heating oven.
- The valve seating (mating) surface has receded beyond factory specifications.
- The valve seating (mating) surface is too wide and recutting or regrinding would lower the seat beyond factory specifications.
- The integral seat of a cast iron head has been ground before. (The depth of the hardened cylinder head material used for the seating area will be too shallow to allow a second grinding)
- There is any evidence that the valve seat insert is loose in the counter bore pocket, or does not have adequate interference fit.
- There is any evidence of corrosion of the cylinder head material around the outside diameter of the valve seat insert.
- There is any evidence that the seat has any cracking, burning, pitting or fissures.
- The fuel type being used is going to be changed. This will require a higher duty range valve seat for better durability.

1.2 Machining practices

Although many factors contribute to the successful machining of valve seats. Here are several key conditions that are required to achieve good results.

- By far the most important is to have properly sharpened tools and properly dressed grinding stones.
- Keep your tooling setup as "short and tight" as possible to assure rigidity (Picture 1). The less deflection in the tooling the more accurate the dimensions of the cut and the greater concentricity.
- Keep your clamping arms and fixtures in good repair for correct gripping.
- Make sure not to distort or put a twist into the cylinder head when clamping to a fixed rail cylinder head holding fixture (Picture 2).
- Use the correct size pilots, which must be straight.
- Use the correct spindle speeds and feeds.

Picture 1

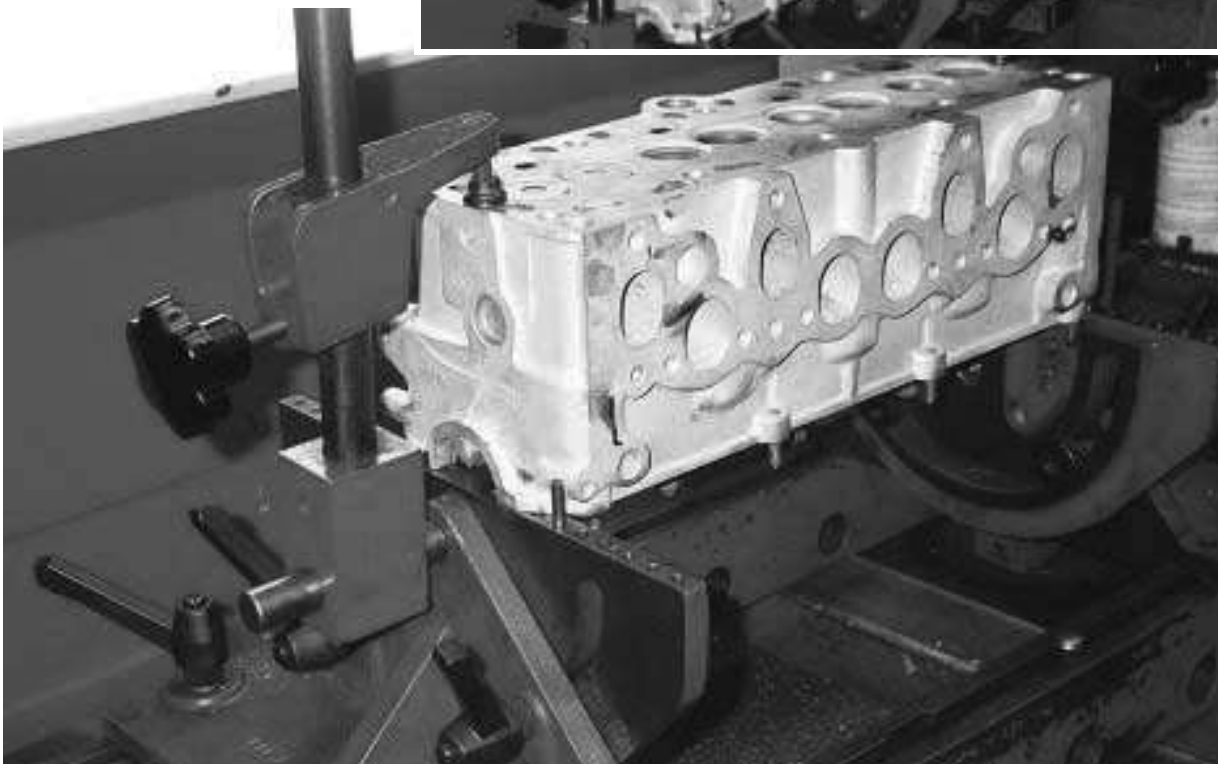

Picture 2

Chapter 2: Cutting valve seat inserts and counter bores

2.1 Removal of valve seats and cutting of seat pocket counter bores

Replacing valve seats in heads with removable seat inserts can be done in several ways, but the method we recommend is to use a cutter slightly smaller than the outside diameter of the existing valve seat insert and cut the old seat out (Picture 3). Stop cutting just as the old seat insert begins to rotate. The thin wall of the old valve seat insert can now be easily removed (Picture 4).

Some machinist will install a new insert in the existing seat pocket without recutting the counter bore. Although this method can be used on some large cast iron cylinder heads which are thick walled, it is not a recommended procedure for most automotive or "light pattern" cylinder heads. It is much better to cut a new seat insert counter bore for better valve life and valve

seat insert retention in the cylinder head (Picture 5). This will also insure concentricity and perpendicularity with the valve guide and will provide a fresh metal surface for better heat transfer (see our recommended interference fit chart for the correct outside diameter).



Picture 3 - Cutting valve seat inserts



Picture 4 - Removing the thin wall of the old valve seat insert



Picture 5 - Cutting the counter bore

When machining the seat pocket counter bore in a **cast iron cylinder head** we recommend a cutting

speed of **100 to 250 RPM** with no cutting oil. When cutting a seat pocket counter bore in **aluminum**

cylinder heads we recommend using a cutting oil and a spindle speed of **400 to 600 RPM**.

DuraBond recommends the following press fittings:

Outer diameter valve seats inserts [inch]	[mm]	Material cylinder head cast iron [inch]	[mm]	Material cylinder head aluminium [inch]	[mm]
0.7874 - 1.1811	20 - 30	0.0031	0,08	0.0047	0,12
1.1811 - 1.5748	30 - 40	0.0043	0,11	0.0059	0,15
1.5748 - 1.9685	40 - 50	0.0051	0,13	0.0071	0,18
1.9685 - 2.3622	50 - 60	0.0063	0,16	0.0079	0,20
2.3622 - 2.7559	60 - 70	0.0071	0,18	0.0087	0,22

Replacing valve seats in cylinder heads with integral seats will require a new seat pocket counter bore to be cut. The approximate outside dia-

meter for the replacement seat is .100" (2,5 mm) larger than the valve head diameter. The inside diameter of the replacement seat is approximate-

ly .100" (2,5 mm) smaller than the valve head diameter. The depth is usually .188" to .250" (4,7 - 6,4 mm). These sizes are guidelines only.

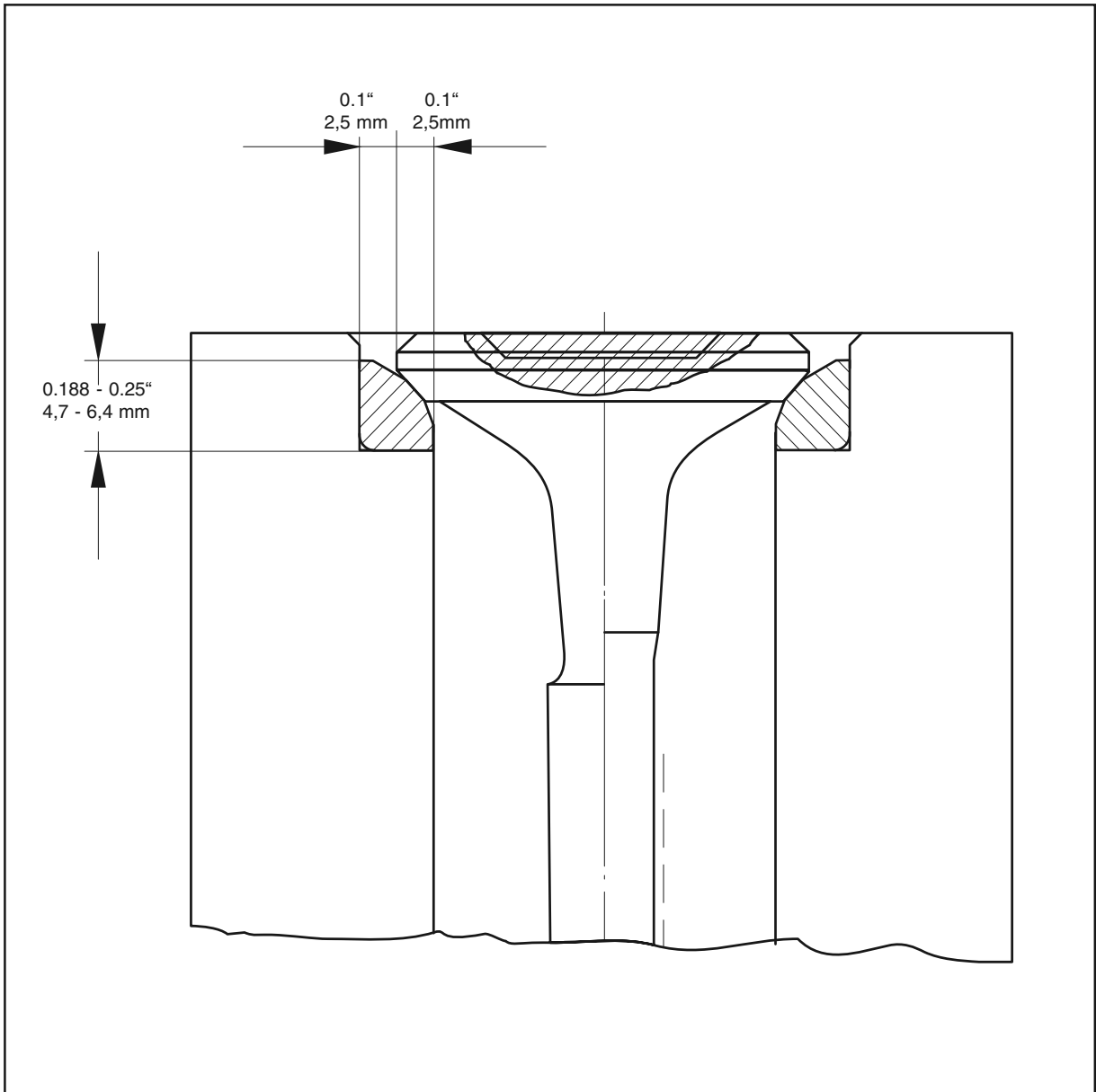

Many of the newer cylinders do not have the room to install seats with OD's larger than the OD of the valve (see our recommended interference fit chart for the correct outside diameter).

All counter bores must be concentric with the valve guide, have a straight wall, flat bottom and be within .0005" (0,013 mm) of correct size and be round.

Chapter 3: Installation

3.1 Inserting the valve seats

Before pressing in the new valve seat insert please be sure:

- Verify that the valve seat dimensional measurements are correct
- Verify the counter bore measurements are correct
- Make sure there are no chips or debris in the counter bore
- Use a seat installation tool to insure that the valve seat is inserted squarely into the counter bore pocket (Picture 6).
- Use a flat and square seat driver tool whose size is just slightly smaller than the outside diameter of the valve seat insert (Picture 7).
- Use a correct size pilot for the valve guide, when using this valve seat driving tool.

For Dura-Bond valve seat inserts:

- **Insert the valve seat with the radius side down.**
- **Because of the smooth radius on the bottom outside edge and the compressive “spring action” of the material, shrinking of the seat using liquid nitrogen and heating the cylinder head is not necessary prior to insertion the cylinder head.**

Picture 7



Picture 6

Less force required - less chance of damaging seat counter bore.

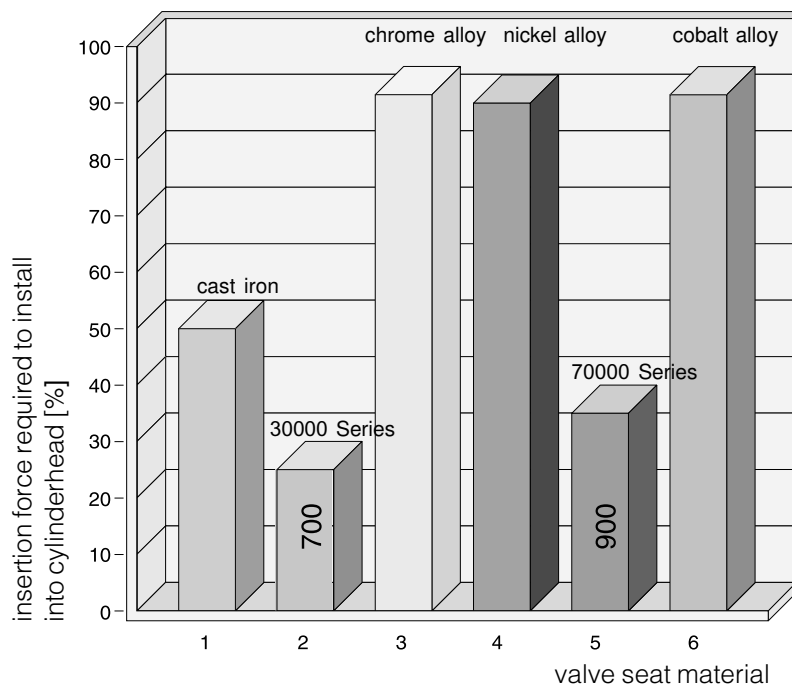

3.2 Cutting the seating surface

Check the engine specification manual for the correct assembled valve height, valve protrusion, seat angles, seat widths and any other special seat requirements. These factory specifications are important to maintain the correct valve lash,

compression ratios, clearances between valves and pistons, and the general overall valve train geometry. Machining and assembling the cylinder head to the original manufacturer's specifications is critical for the correct operation of the engine.

3.3 Using a cutting machine (Picture 8)

- Select a cutter profile matching the original factory valve seat. The top and bottom relief angles, and the seating surface width and angle must match the design called for by the original engine manufacture for the valve train geometry to be correct.
- Select the type and grade of carbide best suited for the hardness of the valve seat being machined.
- Make sure that the tool is sharp and has the correct rake angles and relief angles.
- A 5-degree cutting rake angle with an 11-degree relief or clearance angle is generally found to be best for valve seats up to 1.250" (31,8 mm) in diameter.
- A 3-degree cutting rake angle with a 7-degree relief or clearance angle is generally found to be best for cutting valve seats larger than 1.250" (31,8 mm) in diameter.
- Select the correct spindle speed for the type of seat being cut.
- A spindle speed of 150 to 450 RPM is generally a good speed for cutting the valve seat insert less than 1.500" (38,0 mm) in diameter.
- A spindle speed of 100 to 250 RPM works best for seats larger than 1.500" (38,0 mm) in diameter.
- **Dura-Bond finds that most people who have the drill press style of machine, like the 50 - 100 RPM**
- Set the cutter bit to the correct size for the valve being used according to the factory repair manual.
- Cut the seat depth to match the correct assembled valve height.

Outer Diameter valve seat insert [inch]	[mm]	Tool		RPM [1/min]
		relief angle	cutting angle	
< 1.250	< 31,8	11°	5°	150 - 450
> 1.250	> 31,8	7°	3°	150 - 450
< 1.500	< 38,0	7°	3°	150 - 450
> 1.500	> 38,0	7°	3°	100 - 250



Picture 8

3.4 Using a grinding machine

- Select the correct size of stone for the valve being used.
- Select the correct type of stone for the hardness level of valve seat.
- Dress the stones as needed to the angles specified in the repair manual.
- Grind the seating angle first
- Grind the top relief angle to adjust seat height
- Grind the bottom relief to adjust the seat width.

Adjustments to these grinds will be necessary to achieve the correct assembled valve height and seat width.

In general, if no factory specifications are available, remember to keep the valve face and valve seat contact area to the outer limits of the valve head diameter. Depending on the valve head diameter this contact area will be .015" to .030" (0,4 – 0,8 mm) in from the outside diameter of the valve head. If the seating contact area is too close to the valve stem you will impede the gas flows and build up heat on the exhaust side and possibly restricted power due to less air and fuel getting into the combustion chamber on the intake side. You will get better heat transfer away from the exhaust valve and into the

water jacket if you keep the contact area to the outside diameter of the valve head. But you must not take it to the extreme outside diameter or you will "burn" the valve and seat prematurely, because there will be too much heat concentrated at the very edge of the valve.

Also, in general, for valve seats in the 1.375" to 2.125" (35,0–54,0 mm) diameter range, if no specific factory specifications are available, a general guideline is to make the valve face to valve seat contact area width between .040"-.060" (1,0 – 1,5 mm) for the intake and .060"-.080" (1,5 – 2,0 mm) for the exhaust. For valve seats smaller than 1.250" (31,8 mm) the seat widths will be reduced by one half the values listed above. For engines using LPG, the exhaust seating width should be .100" (2,5 mm).

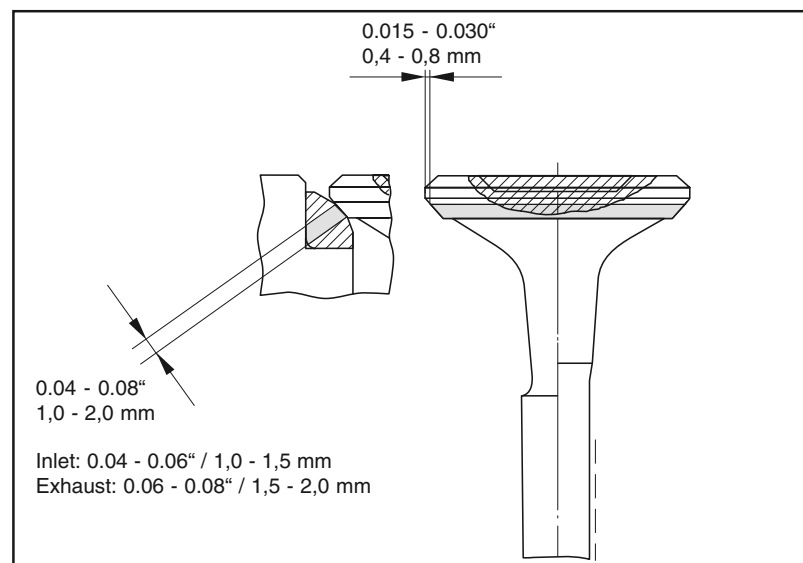

Wider seating widths will give a greater area of surface contact which will give better cooling rates but the larger contact area will reduce the pounds per square inch sealing pressure, so too large of a contact area will cause seats to

"burn" due to gas leakage. Too thin an area will cause high mechanical abrasion forces and high operating temperatures and will "wear" the seating area faster than normal.

3.5 Checking the final product

- Check the sealing by using a vacuum check
- Check the seating position by using Prussian blue on the valve and seat
- Check for the correct assembled valve stem height and valve head protrusion

Chapter 4: Dura-Bond® Valve Seat Inserts

4.1 Valve seat inserts

Materials

Modern engines put much higher levels of thermal and mechanical stress on valve seat inserts. To handle the more severe conditions within these new generations of engines, the OE-Manufacture is equipping them with high tech sintered valve seat inserts. The normal cast iron valve seat will not adequately withstand the demands of this new engine environment.

This is the reason why Dura-Bond offers high tech sintered valve seats in two specifications to be used for the complete range of today's engines and the engines of the past and of the future.

4.2 30000 / 70000 Series

• 30000 (Gold) Series High Machinability

This sintered insert offers a blend of finely dispersed tungsten carbide residing in a matrix of tempered tool steel and special alloy iron particles. With this blend, the 30000 series represents a superb combination of good hardness and good

machinability. The machinability is comparable to cast iron, and this 30000 series shows good wear and heat resistance.

This very machinable material is designed for naturally aspirated and turbocharged engines in the light to upper duty range.

• 70000 (Diamond) Series High Temperature Resistance

This specification has very high heat resistance which will remain even at very high temperatures. The sintered insert is made out of a high speed tool steel (tungsten carbide). This insert also has ceramic like characteristics, which give it very high temperature resistance. It has special additives blended into the matrix which impart high temperature lubricant properties to the valve seat. This solid lubricant enables this material to be used in dry fuel applications, such as propane, LPG and natural gas. They prevent the microwelding of the valve seat material to the valve face.

This eliminates the primary cause of valve seat erosion and failure. This very high heat and wear resistant seat is designed for propane, LPG and natural gas engines, as well as for high performance engines, heavy duty and extremely duty applications.

4.3 Overview

	30000 Series (High Machinability)	70000 Series (High Temperature Resistance)
Fuel type	petrol (unleaded), diesel	propane, LPG, natural gas, petrol (unleaded), diesel
Cylinder head Material	aluminium, cast iron	aluminium, cast iron
Applications	turbocharged engines, aspirated engines, lower to upper duty range	heavy and extreme duty range high performance engines, all gas engines (propane, LPG)

Dimensional specifications must be evaluated in order to assure correct selection of valve seat whenever engine parts are being selected. Heavy duty or extreme service applications should be considered to

assure that the individual engine rebuilder's standards are met and are the responsibility of rebuilder to determine suitability.

VALVE SEAT COMPETITIVE INTERCHANGES

SBI - DURA-BOND VALVE SEATS							
SBI	DURA-BOND	SBI	DURA-BOND	SBI	DURA-BOND	SBI	DURA-BOND
SB 1000-1N	71600	SB 1312-67	30779	SB 1437-56	31329	SB 1536E-2N	71671
SB 1062-50	31047	SB 1312-67PM	30779	SB 1437-6	30803	SB 1562-0	31112
SB 1062-50PM	31047	SB 1312-68	31058	SB 1437-62	30818	SB 1562-0PM	31112
SB 1102E-1N	71168	SB 1312-6PM	31289	SB 1437-62PM	30818	SB 1562-1	30643
SB 1125-1	30754	SB 1312-7	30775	SB 1437-63	31646	SB 1562-1+.005	30643+5
SB 1125-10	31143	SB 1312-9	30736	SB 1437-65	30806	SB 1562-11	30839
SB 1125-2	31097	SB 1339E-2	31174	SB 1437-65PM	30806	SB 1562-12	30841
SB 1125-4	31143	SB 1339E-2N	71174	SB 1437-68	30809	SB 1562-12PM	30841
SB 1125-5	31097	SB 1348E-1N+.005	71633+5	SB 1437-69	31656	SB 1562-16	31870
SB 1125-52	31048	SB 1375-1	30558	SB 1437-6PM	30803	SB 1562-16N	71870
SB 1125-52N	71048	SB 1375-18	30787	SB 1437-72	31659	SB 1562-17	30647
SB 1125-6	31097	SB 1375-1N	70558	SB 1437-73	31658	SB 1562-17PM	30647
SB 1125-8	30754	SB 1375-1PM	30558	SB 1437-8	30802	SB 1562-18	30731
SB 1125-9	31143	SB 1375-2	30791	SB 1437-8PM	30802	SB 1562-1N	70643
SB 1142E-2N	71169	SB 1375-26	31064	SB 1437-9	31225	SB 1562-1N+.005	70643+5
SB 1181E-1	31170	SB 1375-3	30786	SB 1457E-2	31068	SB 1562-1PM	30643
SB 1181E-1N	71170	SB 1375-3N	70786	SB 1457E-2N	71068	SB 1562-2	30503
SB 1187-5	31145	SB 1375-4	30790	SB 1496E-1N	71178	SB 1562-2N	70503
SB 1187-51	31146	SB 1375-4N	70790	SB 1500-0	30715	SB 1562-2PM	30503
SB 1187-53	31868	SB 1375-4PM	30790	SB 1500-1	30711	SB 1562-3	31033
SB 1187-6	31145	SB 1375-5	31157	SB 1500-10	31032	SB 1562-31	31104
SB 1221E-2	31171	SB 1375-50	31102	SB 1500-10PM	31032	SB 1562-34	30839
SB 1221E-2N	71171	SB 1375-51	31064	SB 1500-11	30722	SB 1562-36	30840
SB 1250-1	31147	SB 1375-52	31063	SB 1500-12	30714	SB 1562-36N	70840
SB 1250-1PM	31147	SB 1375-55N	71635	SB 1500-1N	70711	SB 1562-36PM	30840
SB 1250-2	31152	SB 1375-56	30238	SB 1500-1PM	30711	SB 1562-4	30644
SB 1250-3	30764	SB 1375-5N	71157	SB 1500-2	30823	SB 1562-4+.010	30644+10
SB 1250-3PM	30764	SB 1375-6	31125	SB 1500-25	30708	SB 1562-46	30740
SB 1250-4	31152	SB 1375-61	31139	SB 1500-2PM	30823	SB 1562-46N	70740
SB 1250-50	31151	SB 1375-62	31139	SB 1500-3	30712	SB 1562-4PM	30644
SB 1250-52	31054	SB 1375-64	31064	SB 1500-3PM	30712	SB 1562-50	30740
SB 1250-55	31100	SB 1375-65	30787	SB 1500-4	30705	SB 1562-51	31318
SB 1250-56	30230	SB 1375-7	30788	SB 1500-4PM	30705	SB 1562-52	30839
SB 1250-56PM	30230	SB 1375-8	30786	SB 1500-5	30706	SB 1562-54	31292
SB 1250-58	31105	SB 1378E-1N	71175	SB 1500-50	30015	SB 1562-54PM	31292
SB 1250-63	31612	SB 1417E-1N	71176	SB 1500-52	30024	SB 1562-6	30640
SB 1250-64	31613	SB 1437-1	30556	SB 1500-53	31258	SB 1562-66	31286
SB 1250-65	31147	SB 1437-10	31225	SB 1500-53PM	31258	SB 1562-66PM	31286
SB 1260E-1N	71172	SB 1437-14	31402	SB 1500-54	30031	SB 1562-67	31199
SB 1262E-1N	71621	SB 1437-1N	70556	SB 1500-54PM	30031	SB 1562-67PM	31199
SB 1299E-1	31173	SB 1437-1PM	30556	SB 1500-56	30712	SB 1562-69	31287
SB 1299E-1N	71173	SB 1437-2	31031	SB 1500-57	30045	SB 1562-69N	71287
SB 1312-1	30775	SB 1437-24	31225	SB 1500-57PM	30045	SB 1562-69PM	31287
SB 1312-10	31153	SB 1437-25	31111	SB 1500-59	30105	SB 1562-6N	70640
SB 1312-11	31289	SB 1437-2N	71031	SB 1500-6	30822	SB 1562-6PM	30640
SB 1312-4	31056	SB 1437-2PM	31031	SB 1500-63	31291	SB 1562-7	30645
SB 1312-5	31155	SB 1437-3	31030	SB 1500-63PM	31291	SB 1562-70	31079
SB 1312-50	30562	SB 1437-30	31160	SB 1500-64	30105	SB 1562-72	31674
SB 1312-52	30779	SB 1437-3N	71030	SB 1500-65	30105	SB 1562-7PM	30645
SB 1312-56	30562	SB 1437-3PM	31030	SB 1500-6PM	30822	SB 1562-9	30541
SB 1312-56PM	30562	SB 1437-4	30801	SB 1500-73	31244	SB 1562-9N	70541
SB 1312-57	31058	SB 1437-4PM	30801	SB 1500-8	30707	SB 1562-9PM	30541
SB 1312-6	31289	SB 1437-5	31161	SB 1500-9	30709	SB 1575E-3N	71181
SB 1312-61	31628	SB 1437-51	30802	SB 1500-9PM	30709	SB 1614E-1N	71182
SB 1312-61N	71628	SB 1437-54	31067	SB 1535E-1N	71179	SB 1624E-1N	70855

CAUTION: These interchanged valve seats are close dimensionally. They are not necessarily exact duplicates. The suitability for a particular application must be determined by the installer.

VALVE SEAT COMPETITIVE INTERCHANGES

SBI - DURA-BOND VALVE SEATS (Cont.)					
SBI	DURA-BOND	SBI	DURA-BOND	SBI	DURA-BOND
SB 1625-1	30648	SB 1687-13PM	30733	SB 1744E-1N	71086
SB 1625-1+.005	30648+5	SB 1687-15	30872	SB 1750-0	31129
SB 1625-10	30651	SB 1687-15PM	30872	SB 1750-1	30659
SB 1625-10PM	30651	SB 1687-16	30873	SB 1750-11	31045
SB 1625-11	30857	SB 1687-17	30664	SB 1750-1N	70659
SB 1625-14	30732	SB 1687-1N	70670	SB 1750-1PM	30659
SB 1625-18	31488	SB 1687-1PM	30670	SB 1750-2	30658
SB 1625-18PM	31488	SB 1687-2	30664	SB 1750-2N	70658
SB 1625-1N	70648	SB 1687-22	30674	SB 1750-2PM	30658
SB 1625-1PM	30648	SB 1687-23	30676	SB 1750-3	30655
SB 1625-2	30646	SB 1687-24	31042	SB 1750-30	30652
SB 1625-20	30854	SB 1687-26	31042	SB 1750-32	31129
SB 1625-29	30853	SB 1687-27	30674	SB 1750-34	31045
SB 1625-2N	70646	SB 1687-28	30675	SB 1750-38	30658
SB 1625-2PM	30646	SB 1687-29	31042	SB 1750-39	30659
SB 1625-3	30650	SB 1687-2N	70664	SB 1750-3N	70655
SB 1625-33	31046	SB 1687-2PM	30664	SB 1750-3PM	30655
SB 1625-35	31046	SB 1687-3	30673	SB 1750-4	30656
SB 1625-39	31482	SB 1687-32	30873	SB 1750-4N	70656
SB 1625-3N	70650	SB 1687-34	30677	SB 1750-4PM	30656
SB 1625-3PM	30650	SB 1687-3N	70673	SB 1750-5	30657
SB 1625-4	30649	SB 1687-3PM	30673	SB 1750-54	30165
SB 1625-40	30661	SB 1687-4	30559	SB 1750-5PM	30657
SB 1625-4N	70649	SB 1687-40	31490	SB 1750-6	30889
SB 1625-4PM	30649	SB 1687-41	30733	SB 1750-60	31117
SB 1625-5	31489	SB 1687-4N	70559	SB 1750-60PM	31117
SB 1625-52	30663	SB 1687-4PM	30559	SB 1750-61	31215
SB 1625-54	30860	SB 1687-5	30677	SB 1750-61PM	31215
SB 1625-54PM	30860	SB 1687-51	31288	SB 1750-65	31715
SB 1625-55	31690	SB 1687-51PM	31288	SB 1750-68	30165
SB 1625-56	31218	SB 1687-52	31083	SB 1750-68PM	30165
SB 1625-56PM	31218	SB 1687-54	30881	SB 1750-69	31117
SB 1625-5PM	31489	SB 1687-54PM	30881	SB 1750-7	30652
SB 1625-6	30662	SB 1687-55	30559	SB 1750-8	30653
SB 1625-62	31223	SB 1687-56	31707	SB 1750-8N	70653
SB 1625-62PM	31223	SB 1687-56N	71707	SB 1750-9	30654
SB 1625-6PM	30662	SB 1687-5N	70677	SB 1750-9PM	30654
SB 1625-7	30663	SB 1687-5PM	30677	SB 1772E-2N	71227
SB 1625-7PM	30663	SB 1687-6	30675	SB 1781E-1N	71257
SB 1625-9	30661	SB 1687-6PM	30675	SB 1784E-1	31087
SB 1625-9PM	30661	SB 1687-7	30678	SB 1784E-1N	71087
SB 1630E-1N	70642	SB 1687-7PM	30678	SB 1811E-1N	71188
SB 1654E-3	31183	SB 1687-8	30679	SB 1812-0	31459
SB 1654E-3N	71183	SB 1687-8PM	30679	SB 1812-1	30671
SB 1657E-1N	71697	SB 1687-9	30674	SB 1812-10	31000
SB 1669E-1	30868	SB 1687-9N	70674	SB 1812-11	30905
SB 1687-0	31270	SB 1687-9PM	30674	SB 1812-12	31283
SB 1687-0PM	31270	SB 1690E-1N+.005	71701+5	SB 1812-12PM	31283
SB 1687-1	30670	SB 1693E-4	31186	SB 1812-17	31269
SB 1687-10	30679	SB 1693E-4N	71186	SB 1812-18	31131
SB 1687-10N	70679	SB 1722E-1	31709	SB 1812-19	31131
SB 1687-11	30676	SB 1722E-1N	71709	SB 1812-1N	70671
SB 1687-11PM	30676	SB 1732E-1	31187	SB 1812-1PM	30671
SB 1687-12	30871	SB 1732E-1N	71187	SB 1812-2	30668
SB 1687-13	30733	SB 1744E-1	31086	SB 1812-21	30680
				SB 1812-21N	70680
				SB 1812-2PM	30668
				SB 1812-3	30530
				SB 1812-38	30671
				SB 1812-39	31000
				SB 1812-3PM	30530
				SB 1812-4	30667
				SB 1812-4N	70667
				SB 1812-4PM	30667
				SB 1812-5	30672
				SB 1812-52	31327
				SB 1812-52PM	31327
				SB 1812-54	31137
				SB 1812-54PM	31137
				SB 1812-55	31285
				SB 1812-55PM	31285
				SB 1812-59	30672
				SB 1812-5N	70672
				SB 1812-5PM	30672
				SB 1812-6	31089
				SB 1812-7	30904
				SB 1812-7PM	30904
				SB 1812-8	30668
				SB 1812-9	30907
				SB 1812-9N	70907
				SB 1812-9PM	30907
				SB 1812E-3	31827
				SB 1812E-4	31843
				SB 1817E-3	31726
				SB 1818E-1N	70542
				SB 1828E-1	31090
				SB 1828E-1N	71090
				SB 1850E-2	31228
				SB 1850E-2N	71228
				SB 1853E-1	31734
				SB 1853E-1N	71734
				SB 1875-0	31091
				SB 1875-1	30682
				SB 1875-11	30923
				SB 1875-14	30920
				SB 1875-14PM	30920
				SB 1875-15	30688
				SB 1875-17	30684
				SB 1875-19	31238
				SB 1875-19PM	31238
				SB 1875-1N	70682
				SB 1875-1PM	30682
				SB 1875-2	30509
				SB 1875-20	30681
				SB 1875-2PM	30509
				SB 1875-35	30682
				SB 1875-36	30684
				SB 1875-4	30683
				SB 1875-51	31034
				SB 1875-51PM	31034

CAUTION: These interchanged valve seats are close dimensionally. They are not necessarily exact duplicates. The suitability for a particular application must be determined by the installer.

VALVE SEAT COMPETITIVE INTERCHANGES

SBI - DURA-BOND VALVE SEATS (Cont.)							
SBI	DURA-BOND	SBI	DURA-BOND	SBI	DURA-BOND	SBI	DURA-BOND
SB 1875-56	31092	SB 1937-5	31749	SB 2000-38	30692	SB 2087E-2	31195
SB 1875-6	30681	SB 1937-52	31281	SB 2000-3N	70726	SB 2087E-2N	71195
SB 1875-6PM	30681	SB 1937-52PM	31281	SB 2000-4	30702	SB 2088E-1	31771
SB 1875-7	30687	SB 1937-54	31134	SB 2000-6	30725	SB 2125-1	30557
SB 1875-7PM	30687	SB 1937-6	31262	SB 2000-7	30952	SB 2125-11N	71777
SB 1875-9	30919	SB 1937-7	31134	SB 2000-7PM	30952	SB 2125-1N	70557
SB 1875-9PM	30919	SB 1937-8	31471	SB 2001E-1	31756	SB 2125-1PM	30557
SB 1880E-2N	71739	SB 2000-0	30729	SB 2001E-1+.010	31756+10	SB 2125-2	31498
SB 1890E-2N	71189	SB 2000-1	30691	SB 2001E-1N	71756	SB 2125-2PM	31498
SB 1912E-1	31746	SB 2000-12	30723	SB 2004E-2	31758	SB 2125-31	31240
SB 1912E-1N	71746	SB 2000-13	30724	SB 2006E-1	30700	SB 2125-32	31124
SB 1929E-1N	71190	SB 2000-13N	70724	SB 2006E-1N	70700	SB 2125-34	30974
SB 1937-1	30560	SB 2000-14	30727	SB 2006E-2	30703	SB 2125-38	31779
SB 1937-17	30936	SB 2000-15	30698	SB 2006E-6C	91829	SB 2125-4	30537
SB 1937-17PM	30936	SB 2000-15PM	30698	SB 2008E-2N	71193	SB 2125-7N	71776
SB 1937-1PM	30560	SB 2000-16	30699	SB 2018E-1N	71765	SB 2165E-1N.005	71783+5
SB 1937-2	31497	SB 2000-17	30692	SB 2047E-1	31194	SB 2187-1	31135
SB 1937-20	31166	SB 2000-18	30694	SB 2047E-1N	71194	SB 2187-27	31282
SB 1937-23	30935	SB 2000-1N	70691	SB 2049E-1	31766	SB 2187-4	30984
SB 1937-23PM	30935	SB 2000-1PM	30691	SB 2062-1	30964	SB 2250-1	30989
SB 1937-27	30933	SB 2000-2	30700	SB 2062-1PM	30964	SB 2250-13	31787
SB 1937-30	31134	SB 2000-21	30728	SB 2062-2	31769	SB 2250-13N	71787
SB 1937-33	30560	SB 2000-23	30724	SB 2062-25	31249	SB 2312-9	30991
SB 1937-34	30936	SB 2000-27	30730	SB 2062-3	30963	SB 2381E-2	31845
SB 1937-4	30932	SB 2000-29	30701	SB 2062-30N	71770		
SB 1937-4N	70932	SB 2000-35	30703	SB 2062-8	31768		
SB 1937-4PM	30932	SB 2000-36	30690	SB 2062-8N	71768		

CAUTION: These interchanged valve seats are close dimensionally. They are not necessarily exact duplicates. The suitability for a particular application must be determined by the installer.

VALVE SEAT COMPETITIVE INTERCHANGES

SERDI - DURA-BOND VALVE SEATS							
SERDI	DURA-BOND	SERDI	DURA-BOND	SERDI	DURA-BOND	SERDI	DURA-BOND
005999	39006	006023	39040	010488	39026	SS1006B	31174
006000	39007	006024	39042	010489	39029	SS1007A	71175
006001	39008	006025	39043	010491	39035	SS1008A	71176
006002	39009	006026	39045	010492	39038	SS1009A	71068
006003	39010	006027	39046	010493	39041	SS1009B	31068
006004	39012	006028	39048	010494	39044	SS1010A	71178
006005	39013	006029	39049	010495	39047	SS1011A	71179
006006	39015	006030	39051	010496	39050	SS1012A	71181
006007	39016	006031	39052	010497	39053	SS1014A	71183
006008	39018	006033	39057	010498	39056	SS1014B	31183
006009	39019	006034	39059	010499	39058	SS1016A	71187
006010	39021	006035	39060	010500	39061	SS1016B	31187
006011	31273	006036	39062	010501	39065	SS1017A	71227
006012	39024	006037	39063	010502	39069	SS1018A	71188
006013	39025	006038	39066	SS1001A	71168	SS1019A	71228
006014	39027	006039	39067	SS1001SA	71169	SS1019B	31228
006015	39028	009802	39055	SS1002A	71170	SS1020A	71189
006016	39030	009803	39068	SS1002B	31170	SS1021A	71190
006017	39031	010346	31141	SS1003A	71171	SS1023A	71193
006018	39033	010483	39011	SS1003B	31171	SS1024A	71194
006019	31276	010484	39014	SS1004A	71172	SS1024B	31194
006020	39036	010485	39017	SS1005A	71173	SS1025A	71195
006021	39037	010486	39020	SS1005B	31173	SS1025B	31195
006022	39039	010487	39023	SS1006A	71174		

TUCKER - DURA-BOND VALVE SEATS							
TUCKER	DURA-BOND	TUCKER	DURA-BOND	TUCKER	DURA-BOND	TUCKER	DURA-BOND
T1019	71381	T1582	71257	T1657	71111	T1825	70657
T1021	70659	T1601	71269	T1658	70667	T1829	70903
T1022	70740	T1609	70668	T1660	70905	T1833	71019
T1045	70732	T1610	70672	T1663	70671	T1835	70733
T1047	71488	T1613	70919	T1668	71134	T1840	71372
T110	71600	T1614	70932	T1685	71161	T1842	70559
T116	71156	T1616	70667	T1712	70729	T1845	71131
T120	71143	T1617	70671	T1718	71739	T1846	70871
T136	71047	T1620	70509	T1756	71787	T1854	70905
T137	71435	T1621	70932	T1759	70989	T1860	71131
T1509	70651	T1624	70687	T1767	71470	T1861	70871
T1511	71090	T1626	70681	T1771	70989	T1864	71373
T1512	70854	T1627	70682	T1772	70726	T1865	70871
T1513	70658	T1628	70873	T1773	71261	T1866	71131
T1517	70733	T1629	70681	T1781	71497	T1872	70923
T1518	70989	T1630	71497	T1785	70714	T1873	70679
T1519	70664	T1633	70560	T1801	70871	T1874	71165
T1525	70660	T1634	71269	T1803	70654	T1884	70646
T1526	70651	T1635	70668	T1805	71129	T1893	71756
T1530	70732	T1637	71238	T1809	70907	T1900	70673
T1536	70682	T1641	70919	T1810	71131	T1901	70923
T1537	70684	T1643	71000	T1811	70920	T1903	71496
T1540	71261	T1645	70671	T1815	71091	T1911	70932
T1566	71353	T1646	70658	T1820	71091	T1912	70688
T1569	71365	T1647	70684	T1821	71164	T1914	71268
T1570	71765	T1650	71092	T1822	70679	T1915	71765
T1580	70673	T1652	70682	T1824	70657	T1921	70724

CAUTION: These interchanged valve seats are close dimensionally. They are not necessarily exact duplicates. The suitability for a particular application must be determined by the installer.

VALVE SEAT COMPETITIVE INTERCHANGES

TUCKER - DURA-BOND VALVE SEATS (Cont.)							
TUCKER	DURA-BOND	TUCKER	DURA-BOND	TUCKER	DURA-BOND	TUCKER	DURA-BOND
T1923	70726	T229	70803	T321	70537	T7000	71621
T1924	70727	T229+1/16	70709	T322	70984	T7002	71380
T1926	70724	T230	70706	T329	71770	T801	70991
T1929	70853	T2302	71143	T348	70711	T832	70989
T193	71112	T2308	71143	T354	70740	T879	71697
T1936	70682	T231	70707	T358	70705	T883	71372
T1940	70699	T2340	71144	T360	70779	T885	71183
T1941	70700	T2342	71145	T362	70779	T900	70840
T1942	70698	T2351	71054	T365	71496	T904	70675
T1946	71768	T2357	71101	T370	71031	T909	71344
T1955	70698	T237	71225	T372	70700	T910	70647
T1958	70952	T238	71030	T389	71240	T911	70661
T196	71145	T239	71030	T393	70656	T912	70662
T1963	71249	T240	71402	T395	70667	T913	70663
T1965	70700	T244	70822	T397	70677	T915	71128
T1967	70681	T245	71154	T398	70558	T919	70651
T1968	71238	T247	70839	T400	70705	T921	70640
T197	71155	T2523	71364	T417	71137	T922	71488
T1971	71166	T253	70706	T419	71221	T923	70663
T1972	70655	T2531	71163	T429	70712	T924	70640
T1975	71021	T2545	70802	T438	70653	T925	70676
T1979	71746	T256	70722	T439	70712	T928	70838
T1986	71148	T2560	70712	T449	70105	T929	70643
T199	70653	T2561	70712	T453	71756	T929LP	70643
T1991	70654	T257	70786	T468	71185	T934	70649
T1993	70542	T264	70556	T469	70105	T935	70650
T1995	70787	T270	70710	T470	71105	T936	71488
T1996	71419	T271	70711	T475	71137	T937	70674
T2017	71091	T2716	71776	T476	71073	T938	70675
T2018	70542	T272	70712	T478	70839	T939	70644
T2024	71427	T2720	71498	T489	71746	T945	71489
T2026	70905	T2721	71498	T495	70658	T947	71489
T2028	70658	T2742	71498	T496	71776	T951	70648
T2034	70680	T2748	70675	T499	70788	T952	70648
T2035	71503	T2750	70698	T521	70802	T953	70646
T2037	71091	T277	70640	T526	70860	T957	70864
T2038	71129	T278	70645	T540	71221	T960	70677
T204	71152	T279	71161	T542	71287	T961	70678
T2048	71707	T2812	71134	T551	71289	T962	70678
T205	71147	T2813	70686	T559	71289	T964	70541
T2053	70675	T283	71621	T565	70803	T966	70652
T206	70764	T2848	70672	T571	70656	T967	70653
T2081	70839	T2849	71166	T580	71153	T968	70653
T2087	70654	T2852	71249	T585	71178	T976	70670
T213	71289	T288	70711	T586	71175	T981	70664
T217	70786	T295	70712	T598	71776	T982	70673
T219	71125	T298	71125	T599	70802	T983	70655
T221	71011	T299	70801	T606	70675	T984	70656
T222	70790	T300	70690	T617	71165	T986	70658
T223	70558	T301	70691	T625	70238	T987	70659
T224	71157	T302	70692	T634	70673	T990	70644
T225	70791	T305	71777	T635	71380	T995	70659
T226	71225	T306	71776	T638	70791		
T227	70801	T316	70963	T646	71367		
T228	70802	T318	70557	T647	71087		

CAUTION: These interchanged valve seats are close dimensionally. They are not necessarily exact duplicates. The suitability for a particular application must be determined by the installer.

Dura-Bond

VALVE SPRING BOOSTER SHIMS

Available in both case hardened High Performance and regular series



All Dura-Bond shims meet or exceed OEM specifications.

Only prime quality cold rolled steel is used.

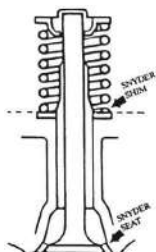

Avoid loss of power due to weak spring tension —
INSTALL BOOSTER SHIMS

Refacing valves and the grinding of valve seats causes loss of metal. This loss of metal results in the loss of proper spring pressure. To restore the proper spring tension, one must replace the lost material by installing a Valve Spring Booster Shim under the valve spring.



1000 SERIES



.015"

3000 SERIES

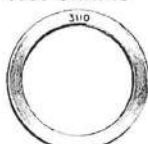

.030"

6000 SERIES

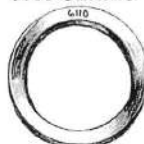

.060"

Cupped Shims are necessary when the spring base pad area is too shallow to hold the regular shim and the spring in the proper position.

3000 SERIES CUPPED SHIM

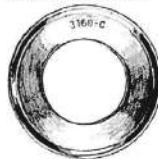

.030"

6000 SERIES CUPPED SHIM

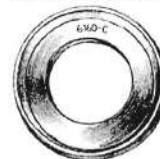

.060"

part number thickness application

3110-C	.030"	American motors, Chrysler, DeSoto,
6110-C	.060"	Dodge, Dodge Truck, Ford, Lincoln, Mercury, Plymouth, Hercules, John Deere
3153-C	.030"	Chevrolet (remachined pad), Chrysler (remachined pad), Ford (remachined pad), Oldsmobile (remachined pad)
3160-C	.030"	American Motors, Chevrolet, Ford, Lincoln, Mercury, Pontiac, Minneapolis-Moline
6160-C	.060"	
3060-C	.030"	Allis Chalmers, Chrysler, General Motors,
6060-C	.060"	International Tractor, John Deere, Mazda, Mercury Marine

STANDARD REBUILDERS PACK: 500 Pieces per Box • Cupped, Industrial, or HP • 250 Pieces per Box

STANDARD PACKAGE: 100 Pieces per Box • Cupped, Industrial, or HP • 50 Pieces per Box

DESIGN FEATURES

Both sides are flat and without serrations or marks of any kind.

- All OEM specifications call for non-serrated shims.
- Non-serrated shims do not damage the spring pad area on today's aluminum cylinder heads.
- Non-serrated shims lay flat so as not to set up any harmonics in the spring.
- Non-serrated shims lay flat so as not to introduce any lateral loads on the spring, valve or guide.

VALVE SPRING BOOSTER SHIMS NUMERICAL LISTING BY PART NUMBER

		PART NUMBER SERIES				ACTUAL O.D.	I.D.
		.015 THICKNESS		.030 THICKNESS			
1003	(C204S)	3003	(B204S)	6003	(A204S)	0.760	0.578
1005	(C204)	3005	(B204)	6005	(A204)	0.796	0.515
1010	(C202)	3010	(B202)	6010	(A202)	0.915	0.643
1011	(C802)	3011	(B802)	6011	(A802)	0.920	0.520
1012	-	3012	-	6012	-	0.960	0.515
1015	-	3015	-	6015	-	0.960	0.625
1020	(C101)	3020	(B101)	6020	(A101)	1.000	0.688
1022	-	3022	-	6022	-	1.000	0.515
1025	(C104)	3025	(B104)	6025	(A104)	1.002	0.766
1030	(C106)	3030	(B106)	6030	(A106)	1.100	0.721
1040	(C300)	3040	(B300)	6040	(A300)	1.124	0.721
1043	(C408)	3043	(B408)	6043	(A408)	1.140	0.570
-	-	3045-I	(B407)	6045-I	(A407)	1.162	0.825
1048	-	3048	-	6048	-	1.215	0.515
1050	(C105)	3050	(B105)	6050	(A105)	1.215	0.876
1052	-	3052	-	6052	-	1.247	0.518
1055	(C107)	3055	(B107)	6055	(A107)	1.250	0.625
1060	(C203)	3060	(B203)	6060	(A203)	1.246	0.814
-	-	3060-C	(B505)	6060-C	(A505)	1.399	0.819
1065	(C107S)	3065	(B107S)	6065	(A107S)	1.250	0.688
1070	(C201)	3070	(B201)	6070	(A201)	1.247	0.877
1080	(C302)	3080	(B302)	6080	(A302)	1.311	0.766
1085	-	3085	-	6085	-	1.311	0.840
1087	-	3087	-	6087	-	1.311	0.890
1090	(C100)	3090	(B100)	6090	(A100)	1.311	0.955
1095	-	3095	-	6095	-	1.330	0.600
1100	(C200)	3100	(B200)	6100	(A200)	1.356	0.642
1110	(C102)	3110	(B102)	6110	(A102)	1.358	1.000
-	-	3110-C	(B502)	6110-C	(A502)	1.544	1.025
1120	(C301)	3120	(B301)	6120	(A301)	1.375	0.766
1125	-	3125	-	6125	-	1.375	1.000
1126	-	3126	-	6126	-	1.375	1.030
1127	-	3127	-	6127	-	1.384	1.018
-	-	3130-I	(B403)	6130-I	(A403)	1.374	0.782
1135	(C306)	3135	(B306)	6135	(A306)	1.438	0.645
1140	(C305)	3140	(B305)	6140	(A305)	1.438	0.766
1145	(C109)	3145	(B109)	6145	(A109)	1.438	1.059
1150	(C303)	3150	(B303)	6150	(A303)	1.476	0.705
1152	(C602)	3152	(B602)	6152	(A602)	1.477	0.765
1153	(C306S)	3153	(B306S)	6153	(A306S)	1.500	0.645
-	-	3153-C	(B506)	6153-C	(A506)	1.633	0.645
1156-I	(C404)	3156-I	(B404)	6156-I	(A404)	1.502	0.874
1160	(C103)	3160	(B103)	6160	(A103)	1.500	1.030
-	-	3160-C	(B503)	6160-C	(A503)	1.633	1.055
1170	(C304)	3170	(B304)	6170	(A304)	1.503	1.155
1175	-	3175	-	6175	-	1.270	0.570
1176	-	3176	-	6176	-	1.400	0.570
1177	-	3177	-	6177	-	1.500	0.570
1178	-	3178	-	6178	-	1.600	0.570
-	-	3180-I	(B401)	6180-I	(A401)	1.604	0.820
1185-S-HP	(C601)	3185-S-HP	(B601)	6185-S-HP	(A601)	1.634	0.643
-	-	3190-I	(B402)	6190-I	(A402)	1.689	1.280
-	-	3200-I	(B400)	6200-I	(A400)	1.751	0.818
-	-	3210-I	(B405)	6210-I	(A405)	1.750	0.890
-	-	3220-I	(B406)	6220-I	(A406)	1.751	1.328

Most of the shims shown in this catalog are available in case hardened ("hp") series.
Use the same part number - just add "hp" to the end.

VALVE SPRING BOOSTER SHIMS PROGRESSIVE LISTING BY OUTSIDE DIAMETER

ACTUAL O.D.	I.D.	PART NUMBER SERIES					
		.015 Thickness		.030 Thickness		.060 Thickness	
0.760	0.578	1003	(C204S)	3003	(B204S)	6003	(A204S)
0.796	0.515	1005	(C204)	3005	(B204)	6005	(A204)
0.915	0.643	1010	(C202)	3010	(B202)	6010	(A202)
0.920	0.520	1011	(C802)	3011	(B802)	6011	(A802)
0.960	0.515	1012	-	3012	-	6012	-
0.960	0.625	1015	-	3015	-	6015	-
1.000	0.515	1022	-	3022	-	6022	-
1.000	0.688	1020	(C101)	3020	(B101)	6020	(A101)
1.002	0.766	1025	(C104)	3025	(B104)	6025	(A104)
1.100	0.721	1030	(C106)	3030	(B106)	6030	(A106)
1.124	0.721	1040	(C300)	3040	(B300)	6040	(A300)
1.140	0.570	1043	(C408)	3043	(B408)	6043	(A408)
1.162	0.825	-	-	3045-I	(B407)	6045-I	(A407)
1.215	0.515	1048	-	3048	-	6048	-
1.215	0.876	1050	(C105)	3050	(B105)	6050	(A105)
1.246	0.814	1060	(C203)	3060	(B203)	6060	(A203)
1.247	0.518	1052	-	3052	-	6052	-
1.247	0.877	1070	(C201)	3070	(B201)	6070	(A201)
1.250	0.625	1055	(C107)	3055	(B107)	6055	(A107)
1.250	0.688	1065	(C107S)	3065	(B107S)	6065	(A107S)
1.270	0.570	1175	-	3175	-	6175	-
1.311	0.766	1080	(C302)	3080	(B302)	6080	(A302)
1.311	0.840	1085	-	3085	-	6085	-
1.311	0.890	1087	-	3087	-	6087	-
1.311	0.955	1090	(C100)	3090	(B100)	6090	(A100)
1.330	0.600	1095	-	3095	-	6095	-
1.356	0.642	1100	(C200)	3100	(B200)	6100	(A200)
1.358	1.000	1110	(C102)	3110	(B102)	6110	(A102)
1.374	0.782	-	-	3130-I	(B403)	6130-I	(A403)
1.375	0.766	1120	(C301)	3120	(B301)	6120	(A301)
1.375	1.000	1125	-	3125	-	6125	-
1.375	1.030	1126	-	3126	-	6126	-
1.384	1.018	1127	-	3127	-	6127	-
1.399	0.819	-	-	3060-C	(B505)	6060-C	(A505)
1.400	0.570	1176	-	3176	-	6176	-
1.438	0.645	1135	(C306)	3135	(B306)	6135	(A306)
1.438	0.766	1140	(C305)	3140	(B305)	6140	(A305)
1.438	1.059	1145	-	3145	-	6145	-
1.476	0.705	1150	(C303)	3150	(B303)	6150	(A303)
1.477	0.765	1152	(C602)	3152	(B602)	6152	(A602)
1.500	0.570	1177	-	3177	-	6177	-
1.500	0.645	1153	(C306S)	3153	(B306S)	6153	(A306S)
1.500	1.030	1160	(C103)	3160	(B103)	6160	(A103)
1.502	0.874	1156-I	(C404)	3156-I	(B404)	6156-I	(A404)
1.503	1.155	1170	(C304)	3170	(B304)	6170	(A304)
1.544	1.025	-	-	3110-C	(B502)	6110-C	(A502)
1.600	0.570	1178	-	3178	-	6178	-
1.604	0.820	-	-	3180-I	(B401)	6180-I	(A401)
1.633	0.645	-	-	3153-C	(B506)	6153-C	(A506)
1.633	1.055	-	-	3160-C	(B503)	6160-C	(A503)
1.634	0.643	1185-S-HP	(C601)	3185-S-HP	(B601)	6185-S-HP	(A601)
1.689	1.280	-	-	3190-I	(B402)	6190-I	(A402)
1.750	0.890	-	-	3210-I	(B405)	6210-I	(A405)
1.751	0.818	-	-	3200-I	(B400)	6200-I	(A400)
1.751	1.328	-	-	3220-I	(B406)	6220-I	(A406)

Most of the shims shown in this catalog are available in case hardened ("hp") series.
Use the same part number - just add "hp" to the end.

VALVE SPRING BOOSTER SHIMS

PROGRESSIVE LISTING BY INSIDE DIAMETER

I.D.	ACTUAL O.D.	PART NUMBER SERIES					
		.015 Thickness		.030 Thickness		.060 Thickness	
0.515	0.796	1005	(C204)	3005	(B204)	6005	(A204)
0.515	0.960	1012	-	3012	-	6012	-
0.515	1.000	1022	-	3022	-	6022	-
0.515	1.215	1048	-	3048	-	6048	-
0.518	1.247	1052	-	3052	-	6052	-
0.520	0.920	1011	(C802)	3011	(B802)	6011	(A802)
0.570	1.140	1043	(C408)	3043	(B408)	6043	(A408)
0.570	1.270	1175	-	3175	-	6175	-
0.570	1.400	1176	-	3176	-	6176	-
0.570	1.500	1177	-	3177	-	6177	-
0.570	1.600	1178	-	3178	-	6178	-
0.578	0.760	1003	(C204S)	3003	(B204S)	6003	(A204S)
0.600	1.330	1095	-	3095	-	6095	-
0.625	0.960	1015	-	3015	-	6015	-
0.625	1.250	1055	(C107)	3055	(B107)	6055	(A107)
0.642	1.356	1100	(C200)	3100	(B200)	6100	(A200)
0.643	0.915	1010	(C202)	3010	(B202)	6010	(A202)
0.643	1.634	1185-S-HP	(C601)	3185-S-HP	(B601)	6185-S-HP	(A601)
0.645	1.438	1135	(C306)	3135	(B306)	6135	(A306)
0.645	1.500	1153	(C306S)	3153	(B306S)	6153	(A306S)
0.645	1.633	-	-	3153-C	(B506)	6153-C	(A506)
0.688	1.000	1020	(C101)	3020	(B101)	6020	(A101)
0.688	1.250	1065	(C107S)	3065	(B107S)	6065	(A107S)
0.705	1.476	1150	(C303)	3150	(B303)	6150	(A303)
0.721	1.100	1030	(C106)	3030	(B106)	6030	(A106)
0.721	1.124	1040	(C300)	3040	(B300)	6040	(A300)
0.765	1.477	1152	(C602)	3152	(B602)	6152	(A602)
0.766	1.002	1025	(C104)	3025	(B104)	6025	(A104)
0.766	1.311	1080	(C302)	3080	(B302)	6080	(A302)
0.766	1.375	1120	(C301)	3120	(B301)	6120	(A301)
0.766	1.438	1140	(C305)	3140	(B305)	6140	(A305)
0.782	1.374	-	-	3130-I	(B403)	6130-I	(A403)
0.814	1.246	1060	(C203)	3060	(B203)	6060	(A203)
0.818	1.751	-	-	3200-I	(B400)	6200-I	(A400)
0.819	1.399	-	-	3060-C	(B505)	6060-C	(A505)
0.820	1.604	-	-	3180-I	(B401)	6180-I	(A401)
0.825	1.162	-	-	3045-I	(B407)	6045-I	(A407)
0.840	1.311	1085	-	3085	-	6085	-
0.874	1.502	1156-I	(C404)	3156-I	(B404)	6156-I	(A404)
0.876	1.215	1050	(C105)	3050	(B105)	6050	(A105)
0.877	1.247	1070	(C201)	3070	(B201)	6070	(A201)
0.890	1.311	1087	-	3087	-	6087	-
0.890	1.750	-	-	3210-I	(B405)	6210-I	(A405)
0.955	1.311	1090	(C100)	3090	(B100)	6090	(A100)
1.000	1.358	1110	(C102)	3110	(B102)	6110	(A102)
1.000	1.375	1125	-	3125	-	6125	-
1.018	1.384	1127	-	3127	-	6127	-
1.025	1.544	-	-	3110-C	(B502)	6110-C	(A502)
1.030	1.375	1126	-	3126	-	6126	-
1.030	1.500	1160	(C103)	3160	(B103)	6160	(A103)
1.055	1.633	-	-	3160-C	(B503)	6160-C	(A503)
1.059	1.438	1145	(C109)	3145	(B109)	6145	(A109)
1.155	1.503	1170	(C304)	3170	(B304)	6170	(A304)
1.280	1.689	-	-	3190-I	(B402)	6190-I	(A402)
1.328	1.751	-	-	3220-I	(B406)	6220-I	(A406)

Most of the shims shown in this catalog are available in case hardened ("hp") series.

Use the same part number - just add "hp" to the end.

Dura-Bond®

Engine Hardware & Engine Hardware Finishing Kits

FINISHING KITS®

ENGINE HARDWARE



Dura-Bond now has a line of engine hardware available.

The engine tear down and cleaning process can lead to broken, bent, distorted, or lost service parts. These items can be troubling to any engine rebuilder, especially when they are difficult to obtain. That is why Dura-Bond offers many of the hard to find OEM service parts you need at substantially lower prices.

- Manufactured to precise OEM dimensions for exact fit
- Extensive product coverage
- Lower prices mean more profits to rebuilders
- Offer hard to find and OEM discontinued parts

If you have any additional OEM hardware needs, we invite you to inquire.



We Make It, Not Just Distribute It!

For further information, please contact Dura-Bond Bearing.

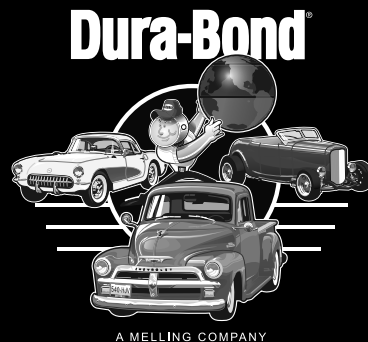

3200 Arrowhead Drive, Carson City, NV 89706 • 1-800-227-8360 • www.dura-bondbearing.com

ENGINE HARDWARE

PART NO.	MAKE & APPLICATION	PRODUCT TYPE	DIMENSION		
			O.D.	I.D.	LENGTH
AMC					
CAM BOLTS & WASHERS					
AB-030-P	3.3L (199ci), 3.8L (232ci), 4.0L (242ci), 4.2L (258ci)	Bolt	1/2-20 x 1-1/4 Hex		
AW-011-P	3.3L (199ci), 3.8L (232ci), 4.0L (242ci), 4.2L (258ci)	Washer	2-1/16 x 1/2 x 3/16 Washer		
HEAD DOWELS					
AD-258	2.5L (150ci), 4.0L (242ci), 4.2L (258ci), 5.0L (304ci), 5.9L (360ci), 5.6L (390ci 1970 Only), 6.6L (401ci)	Hollow Dowel	0.6250	0.523	0.500
AD-927-P	3.3L (199ci), 3.8L (232ci), 4.0L (242ci), 4.2L (258ci)	Solid Dowel	0.3125	Solid	0.565
AD-0112	1966-69 (290ci), (343ci), (390ci) w/1970-Later Heads	Stepped Hollow Dowel	0.6250 / 0.5620	0.450	0.500
OIL FILTER PIN					
AD-007-P	(199ci-258ci)	Roll Pin	1/4 x 1-1/2		
OIL PUMP DOWELS					
AD-148	3.8L (232ci), 4.0L (242ci), 4.2L (258ci)	Hollow Dowel	0.5615	0.454	0.812
TRANSMISSION DOWELS					
AD-148	3.3L (199ci), 3.8L (232ci), 4.0L (242ci), 4.2L (258ci), (290ci), (304ci), (343ci), (360ci), (390ci), (401ci)	Hollow Dowel	0.5615	0.454	0.812
WOODRUFF KEYS					
AK-002-P	3.3L (199ci), 3.8L (232ci), 4.0L (242ci), 4.2L (258ci)	Woodruff Key	3/16 x 3/4		
AK-010-P	3.3L (199ci), 3.8L (232ci), 4.0L (242ci), 4.2L (258ci)	Woodruff Key	3/16 x 7/8		
CATERPILLAR					
SPRING RETAINERS					
SR-779	Caterpillar 3116 Series	Spring Retainer	Valve Stem Diameter 0.315		
VALVE SPRING SPACER					
SP-7488	Caterpillar 3304, 3306 Series	Spacer	1.3750	0.675	1.083
CHRYSLER					
CAM BOLTS & WASHERS					
AB-012-P	(273ci-360ci) "LA" V8	Bolt	7/16-14 x 1-1/4 Hex		
AW-002-P	(273ci-360ci) "LA" V8	Cupped Washer	1-1/2 x 7/16 x 5/16 Washer		
AW-005-P	5.2L (318ci), 5.9L (360ci) w/Roller Cam	Cupped Washer	1-1/2 x 7/16 x 7/16 Washer		
AW-006-P	5.2L (318ci), 5.9L (360ci) w/Roller Cam, (361ci-440ci) V8	Tapered (Bellville) Washer	1-1/2 x 7/16 x 1/8 Washer		
AB-040-P	(361ci-440ci) V8	Bolt	7/16-14 x 1 Hex		
AB-042-P	(361ci-440ci) V8	Bolt	3/8-16 x 3/4 Hex		
CAM CHAIN OIL TABS					
AS-001-P	(273ci-360ci) "LA" V8	Chain Oil Tab	N/A	N/A	N/A
CAM SPROCKET DOWELS					
AD-402	2.2L, 2.5L Mitsubishi SOHC Vin A-E, J, K.	Solid Dowel	0.2318	Solid	0.630
CAM TRAY BOLTS					
AB-005-P	5.2L (318ci), 5.9L (360ci) w/Roller Cam	Bolt	5/16-18 x 5/8 Flanged Hex		
DISTRIBUTOR TOWER SHAFT BUSHINGS					
AD-584	(318ci-440ci) "LA" V8	Distributor Tower Shaft Bushing	N/A	N/A	N/A

ENGINE HARDWARE

PART NO.	MAKE & APPLICATION	PRODUCT TYPE	DIMENSION		
			O.D.	I.D.	LENGTH
CHRYSLER (Cont'd)					
HEAD DOWELS					
AD-111	2.0L, 2.4L, 2.6L Includes Mitsubishi Eng.	Hollow Dowel	0.6300	0.500	0.505
AD-402	2.2L, 2.5L Mitsubishi SOHC Vin A-E, J, K.	Solid Dowel	0.2318	Solid	0.630
AD-849	2.4L, 2.6L G54B 2.7L Includes Mitsubishi Eng.	Hollow Dowel	0.6310	0.500	0.485
AD-856	3.3L (202ci)	Hollow Dowel	0.5913	0.452	0.488
AD-927-P	(273ci-360ci) "LA" V8	Solid Dowel	0.3125	Solid	0.565
AD-1284-P	(361ci-440ci) V8	Solid Dowel	0.2466	Solid	0.630
SPARK PLUG TUBES					
SPT-1	2.0L, 3.2L, 3.5L	Spark Plug Tube	1.0275	0.965	5.035
SPRING RETAINERS					
SR-627	2.5L (150ci) (1998-2002), 4.0L (243ci) (1999-2006)	Spring Retainer	Valve Stem Diameter 0.311/0.312		
SR-570	4.7L (287ci)	Spring Retainer	Valve Stem Diameter 0.272/0.273		
SR-318	5.2L (318ci), 5.9L (360ci) (Early)	Spring Retainer	Valve Stem Diameter 0.370/0.373		
SR-626	5.2L (318ci), 5.9L (360ci) (Late)	Spring Retainer	Valve Stem Diameter 0.311/0.312		
THRUST PLATE BOLTS					
AB-001-P	(318ci-360ci) "LA" V8	Cam Thrust Plate Bolt	5/16-18 x 3/4 Hex		
TIMING COVER DOWELS					
AD-1284-P	(361ci-440ci) V8	Solid Dowel	0.2466	Solid	0.630
TRANSMISSION DOWELS					
AD-849	2.4L, 2.6L G54B 2.7L Includes Mitsubishi Eng.	Hollow Dowel	0.6310	0.500	0.485
AD-021	2.4L, 2.7L, 3.3L Includes Mitsubishi Eng.	Hollow Dowel	11mm	8.5mm	8.3mm
AD-270	2.7L	Hollow Dowel	0.5510	0.410	0.485
AD-532	3.9L V6, (318ci-440ci) "LA" V8	Solid Dowel	0.4960	Solid	0.740
WOODRUFF KEYS					
AK-002-P	(273ci-360ci) "LA" V8	Woodruff Key	3/16 x 3/4		
AK-005-P	(273ci-440ci) "LA" V8	Woodruff Key	3/16 x 1-13/16		
FORD					
BELLHOUSING DOWELS					
AD-397A	5.4L	Hollow Dowel	0.6305	0.469	0.984
CAM BOLTS & WASHERS					
AB-032-P	3.8L (232ci)	Bolt & Washer	10mm-1.5 x 34mm Hex, 35mm Integral Washer		
AB-009-P	(221ci-351ci) Windsor V8, (370ci-460ci) "Lima" V8	Bolt	3/8-16 x 1-1/2 Hex		
AW-001-P	(221ci-351ci) Windsor V8, (370ci-460ci) "Lima" V8	Washer	1-1/4 x 3/8 x 1/4 Washer		
AB-013-P	(332ci-428ci) "FE" V8	Bolt	7/16-14 x 1-3/4 Hex		
AW-003-P	(332ci-428ci) "FE" V8	Washer	1-1/4 x 7/16 x 1/4 Washer		
AB-014-P	(460ci) V8 w/Fuel Injection	Bolt	3/8-16 x 1-3/8 Hex		
CAM ECCENTRIC					
AE-001-P	(255ci-351ci) Windsor V8 (1968-later), 351M, 400M, (460ci) V8	Cam Eccentric - Inner	N/A	N/A	N/A
AE-002-P	(255ci-351ci) Windsor V8 (1968-later), 351M, 400M, (460ci) V8, (332ci-428ci) "FE" V8	Cam Eccentric - Outer	N/A	N/A	N/A
AE-003-P	5.0L (302ci), 5.8L (351ci) w/Fuel Injection	Cam Eccentric (FI)	N/A	N/A	N/A
AE-004-P	(332ci-428ci) "FE" V8	Cam Eccentric - Inner	N/A	N/A	N/A

ENGINE HARDWARE

PART NO.	MAKE & APPLICATION	PRODUCT TYPE	DIMENSION		
			O.D.	I.D.	LENGTH
FORD (Cont'd)					
CAM SPROCKET DOWELS					
AD-005-P	(302ci) 351W w/Two Piece Eccentric, 351C/M, 400M, (429ci, 460ci)	Solid Dowel	0.3115	Solid	1.125
AD-004-P	(221ci-351ci) Windsor V8 w/One Piece Eccentric	Solid Dowel	0.3115	Solid	1.375
AD-006-P	(332ci-428ci) "FE" V8	Solid Dowel	0.3090	Solid	1.500
CAM TRAY BOLTS					
AB-011-P	5.0L (302ci), 5.8L (351ci) w/Roller Cam	Cam Tray Bolt	1/4-20 x 1/2 Place Bolt, Hex		
COOLANT TUBES					
TC-1	4.6L, 5.4L	Coolant Tube (O-Ring)	0.8750	0.437	1.915
TC-1-OO	4.6L, 5.4L	O-Ring For TC-1	N/A	N/A	N/A
TC-2	4.6L, 5.4L	Coolant Tube (Slip-Fit)	0.9800	0.500	2.438
FLYWHEEL DOWELS					
AD-6397	4.6L, 5.0L (302ci)	Stepped Solid Dowel	0.2485 / 0.3140	Solid	0.700
HEAD DOWELS					
AD-849	1.8L (110ci), 2.0L (121ci) Courier Eng.	Hollow Dowel	0.6310	0.500	0.485
AD-300	2.3L	Hollow Dowel	0.5555	0.468	0.470
AD-600	3.0L	Hollow Dowel	0.6050	0.475	0.550
AD-011-P	3.8L (232ci)	Hollow Dowel (Split)	17mm	15mm	19mm
AD-008-P	4.9L (300ci), 3.6L (221ci), 4.2L (255ci), 4.3L (260ci), 4.5L (272ci), 4.7L (289ci), 5.0L (302ci), 5.8L (351ci), 6.6L (400ci)	Hollow Dowel	0.6745	0.552	0.435
AD-008A-P	(332ci-428ci) "FE" V8, (370ci-460ci) "Lima" V8	Hollow Dowel (Split)	0.7400	0.625	0.445
HEAD PLUGS					
AP-020	MZR Eng.	Aluminum Plug	0.3645	Solid	0.360
MANIFOLD DOWELS					
AD-025-P	(400ci) 351C, 351M	Solid Dowel	0.2500	Solid	0.500
OIL PUMP DOWELS					
AD-230	2.0L, 2.3L Escort, Pinto	Hollow Dowel	0.7200	0.615	0.395
OIL GALLEY PLUGS					
AP-001-P	4.9L (300ci)	Oil Galley Plug	1/16-27 x 1/4 Internal Hex		
PEDESTAL SHIMS					
S-100	(302ci, 351ci) W, C, M, 400ci, (370ci-429ci-460ci) w/Pedestal Mount Rocker Arms	Pedestal Shim	.020" Thickness		
SPACER					
SP-6265	4.6L	Spacer	1.8500	1.446	0.441
AS-002	4.9L (300ci)	Spacer	1.5160	1.255	0.194
SPRING RETAINERS					
SR-183	1.6L (98ci), 1.9L (116ci), 3.0L (183ci)	Spring Retainer	Valve Stem Diameter 0.316		
SR-536	2.8L, 2.9L, 4.0L	Spring Retainer	Valve Stem Diameter 0.315/0.316		
SR-502	4.7L (289ci) Hi Perf.	Spring Retainer	Valve Stem Diameter 0.342		
TENSIONER BOLTS					
AB-034-P	3.8L (232ci)	Bolt	6mm-1.0 x 14mm Hex		

ENGINE HARDWARE

PART NO.	MAKE & APPLICATION	PRODUCT TYPE	DIMENSION		
			O.D.	I.D.	LENGTH
FORD (Cont'd)					
THRUST PLATE BOLTS					
AB-033-P	3.8L (232ci)	Cam Thrust Plate Bolt	6mm-1.0 x 19mm Flat Head Torx		
AB-033-P	3.8L (232ci)	Balance Shaft Thrust Plate Bolt	6mm-1.0 x 19mm Flat Head Torx		
AB-010-P	4.7L (289ci), 5.0L (302ci), 5.8L (351ci)	Cam Thrust Plate Bolt	1/4-20 x 5/8 Hex		
AB-001-P	4.9L (300ci)	Cam Thrust Plate Bolt	5/16-18 x 3/4 Hex		
AB-015-P	(332ci-428ci) "FE" V8	Cam Thrust Plate Bolt	7/16-14 x 5/8 Hex		
AB-011-P	7.5L (460ci)	Cam Thrust Plate Bolt	1/4-20 x 1/2 Place Bolt, Hex		
TIMING COVER DOWELS					
AD-015	2.3L	Hollow Dowel	0.3140	0.261	0.455
AD-520	3.8L (232ci), 4.2L	Hollow Dowel	0.4881	0.400	0.670
AD-967	4.7L (289ci), 5.0L (302ci), 5.8L (351ci)	Hollow Dowel	0.4820	0.385	0.550
TRANSMISSION DOWELS					
AD-E7RY	2.0L	Hollow Dowel	0.5010	0.406	0.650
AD-521	3.0L, 3.8L (232ci), 4.2L (255ci)	Hollow Dowel	0.6074	0.510	0.800
AD-397	3.8L (232ci), 4.2L (255ci), 4.7L (289ci), 4.9L (300ci), 5.0L (302ci), 5.8L (351ci), 5.9L (360ci), 6.7L (390ci), 6.6L (400ci), 7.5L (460ci)	Solid Dowel Pin	0.5000	Solid	1.000
WATER PUMP DOWELS					
FD-1-1	2.8L (171ci)	Hollow Dowel	0.9395	0.834	0.572
WOODRUFF KEYS					
AK-003-P	3.8L (232ci), 4.7L (289ci), 5.0L (302ci), 5.8L (351ci)	Woodruff Key	3/16 x 1-13/32		
AK-004-P	4.7L (289ci), 4.9L (300ci), 5.0L (302ci), 5.8L (351ci)	Woodruff Key	3/16 x 1-3/4		
AK-002-P	4.9L (300ci)	Woodruff Key	3/16 x 3/4		
AK-006-P	(332ci-428ci) "FE" V8	Woodruff Key	3/16 x 1-13/32		
AK-007-P	351C, 351M, (400ci), 7.5L (460ci)	Woodruff Key	3/16 x 1-3/4		
AK-008-P	7.5L (460ci)	Woodruff Key	1/4 x 7/8		
GENERAL MOTORS					
BALANCE SHAFT GEAR BOLTS & WASHERS					
AB-026-P	4.3L (262ci)	Bolt	3/8-16 x 1-1/4 Bolt, Hex		
AW-007-P	4.3L (262ci)	Flat Washer	3/8 Washer		
AW-006-P	4.3L (262ci)	Tapered Washer	1-1/2 x 7/16 x 1/8 Washer		
BYPASS VALVES					
AV-001-P	1.4L (85ci), 1.6L (97ci), 1.8L (110ci), 2.0L (122ci), 2.8L (173ci), 3.8L (229ci), 4.3L (262ci), 4.9L (301ci) 11 psi	Bypass Valve	N/A	N/A	N/A
AV-580-PHD	1.4L (85ci), 1.6L (97ci), 1.8L (110ci), 2.0L (122ci), 2.8L (173ci), 3.8L (229ci), 4.3L (262ci), 4.9L (301ci) 21 psi	Bypass Valve	N/A	N/A	N/A
AV-280-P	2.3L (140ci), 2.5L (151ci), 3.2L (194ci), 3.8L (230ci), 4.1L, (250ci), 4.8L (292ci)	Bypass Valve	N/A	N/A	N/A
CAM BOLTS & WASHERS					
AB-007-P	4.3L (262ci)	Bolt	5/16-18 x 1-3/8 Cap Screw, Hex		
AB-019-P	4.3L (262ci)	Bolt	5/16-18 x 1-1/2 Hex		
AW-009-P	4.3L (262ci)	Washer	5/16 Star Washer		
AB-001-P	(262ci-400ci) Small Block V8, (366ci-454ci) Big Block V8	Bolt	5/16-18 x 3/4 Hex		
AB-031-P	(265ci-455ci) Pontiac V8	Bolt	1/2-20 x 1 Hex		
AW-010-P	(265ci-455ci) Pontiac V8	Washer	1-3/8 x 1/2 x 3/16 Washer		
CAM BOX DOWELS					
AD-022	3.4L (207ci)	Hollow Dowel	0.4350	0.343	0.500

ENGINE HARDWARE

PART NO.	MAKE & APPLICATION	PRODUCT TYPE	DIMENSION		
			O.D.	I.D.	LENGTH
GENERAL MOTORS (Cont'd)					
CAM BOX DOWELS					
AD-024	2.2L Ecotech	Hollow Dowel	0.3937	0.328	0.627
CAM LOCK PLATE					
AW-013-P	All Other GM V6 / V8 Hi Perf.	Cam Lock Plate	N/A	N/A	N/A
CAM SPACER					
SP-230	3.8L (230ci)	Cam Spacer	1.5050	1.288	0.139
CAM TRAY BOLTS					
AB-005-P	4.3L (262ci), 5.0L (305ci), 5.7L (350ci) w/Roller Cam	Bolt	5/16-18 x 5/8 Flanged Hex		
CRANK PINS					
AD-679	(262ci-400ci) Small Block V8, (366ci-454ci) Big Block V8	Solid Dowel	0.4386	Solid	0.813
CRANKSHAFT INSERTS					
AD-699	2.5L w/Automatic Trans.	Crankshaft Insert	1.4985	0.830	0.924
AD-605	2.5L w/Manual Trans.	Crankshaft Insert	1.4985	1.092	1.075
FLAT LIFTER PLUG BOLTS					
AB-027-P	5.7L (350ci)	Bolt	15/16-18 x 1/2 Hex		
FUEL PUMP BOLTS & WASHERS					
AB-021-P	(262ci-400ci) Small Block V8	Bolt	3/8-16 x 5/8 Hex		
AW-007-P	(262ci-400ci) Small Block V8	Flat Washer	3/8 Washer		
HEAD DOWELS					
AD-189	Geo 1.3L, 1.6L, Suzuki G13, G16 Eng.	Hollow Dowel	0.5113	0.406	0.700
AD-050	2.3L (138ci), 2.4L (146ci)	Hollow Dowel	0.5562	0.500	0.745
AD-927-P	(262ci-400ci) Small Block V8, (265ci-455ci) Pontiac V8	Solid Dowel	0.3125	Solid	0.565
AD-013	4.1L Cadillac (FWD)	Hollow Dowel	0.5820	0.484	0.945
AD-018	4.1L Cadillac (RWD)	Hollow Dowel (Stepped)	0.5820 / 0.5910	0.484	0.945
AD-352	4.6L Cadillac Northstar	Hollow Dowel	0.6165	0.500	1.100
AD-326	4.8L, 5.3L, 6.0L	Hollow Dowel	0.6420	0.516	0.500
AD-8081-P	(366ci-454ci) Big Block V8	Hollow Dowel	0.6400	0.500	0.500
AD-347	Geo, Suzuki Eng.	Hollow Dowel	0.3900	0.281	0.272
OIL DIPSTICK PLUGS					
AP-013	5.0L (305ci), 5.7L (350ci) Marine	Oil Dipstick Plug	N/A	N/A	N/A
AP-014	4.3L (262ci)	Oil Dipstick Plug	N/A	N/A	N/A
OIL FILTER ADAPTER BOLTS					
AB-039-P	All Other GM V6 / V8 Hi Perf.	Bolt	5/16-18 x 1-1/16		
OIL GALLEY PLUGS					
AP-003-P	4.3L (262ci)	Oil Galley Plug	3/8-18 x .46 Internal Hex, w/Sealant		
CB-001-P	4.3L (262ci), 5.7L (350ci), 6.6L (400ci)	Oil Galley Rear Main Plug	12MM Check Ball		
AP-002-P	(262ci-400ci) Small Block V8	Oil Galley Plug	1/4-18 x .33 Internal Hex, w/Sealant		
OIL PAN BOLTS					
AB-020-P	4.3L (262ci)	Oil Pan Bolt (Aluminum Pan)	5/16-18 x 7/8 Frame Bolt, Hex		
AB-016-P	4.3L (262ci)	Oil Pan Bolt (Steel Pan)	1/4-20 x 3/4 Frame Bolt, Hex		
AB-023-P	(262ci-400ci) Small Block V8	Oil Pan Bolt	5/16-18 x 5/8 Sims Bolt, Hex		
AB-010-P	(262ci-400ci) Small Block V8	Oil Pan Bolt (With Rails)	1/4-20 x 5/8 Hex		
AB-024-P	(262ci-400ci) Small Block V8	Oil Pan Bolt (Without Rails)	1/4-20 x 1/2 Sims Bolt, Hex		
AB-016-P	(262ci-400ci) Small Block V8	Oil Pan Bolt (Steel Pan w/ Rails)	1/4-20 x 3/4 Frame Bolt, Hex		

ENGINE HARDWARE

PART NO.	MAKE & APPLICATION	PRODUCT TYPE	DIMENSION		
			O.D.	I.D.	LENGTH
GENERAL MOTORS (Cont'd)					
OIL PAN DRAIN PLUG WASHERS					
AW-008-P	(262ci-400ci) Small Block V8	Nylon Washer	1/2 x .900 x .078 Washer		
OIL PAN STUDS & NUTS					
ST-002-P	4.3L (262ci)	Oil Pan Stud (Aluminum Pan)	Stud 5/16-18 x 2-1/2		
ST-001-P	(262ci-400ci) Small Block V8	Oil Pan Stud (Steel Pan)	Stud 5/16-18 x 1-9/16 Torx		
AN-002-P	(262ci-400ci) Small Block V8	Oil Pan Stud Nut	5/16 Flange Nut, Hex		
OIL PUMP BOLTS					
AB-022-P	(262ci-400ci) Small Block V8	Oil Pump Bolt (Short Version)	7/16-14 x 2 Bolt, Hex		
AB-018-P	(262ci-400ci) Small Block V8	Oil Pump Bolt (Long Version)	7/16-14 x 2-1/4 Bolt, Hex		
OIL PUMP DOWELS					
AD-SS	1.3L	Hollow Dowel	0.3546	0.266	0.390
AD-250	4.1L (250ci), 4.8L (292ci)	Hollow Dowel	0.7600	0.640	0.635
AD-1284-P	(262ci-400ci) Small Block V8, (366ci-454ci) Big Block V8	Solid Dowel	0.2466	Solid	0.630
OIL PUMP DRIVE ROD BUSHINGS					
AD-842	2.5L	Drive Rod Bushing	0.7570	0.491	1.160
OIL PUMP SLEEVES					
AD-010-P	4.3L (262ci), 4.6L (283ci), 5.3L (327ci), 5.7L (350ci), 6.6L (400ci)	Nylon Sleeve	0.6120	0.466	0.600
PEDESTAL SHIMS					
S-220-10-P	2.2L (134ci)	Pedestal Shim	.010" Thickness		
S-220-20-P	2.2L (134ci)	Pedestal Shim	.020" Thickness		
S-006-10-P	3.1L (189ci), 3.4L (207ci)	Pedestal Shim	.010" Thickness		
S-006-20-P	3.1L (189ci), 3.4L (207ci)	Pedestal Shim	.020" Thickness		
S-006-30-P	3.1L (189ci), 3.4L (207ci)	Pedestal Shim	.030" Thickness		
REAR MAIN DOWELS					
AD-SS	2.2L	Hollow Dowel	0.3546	0.266	0.390
RETAINING LINKAGE SHAFT PIN					
PIN-1-P	4L80 Transmission	Retaining Linkage Shaft Pin	N/A	N/A	1.120
ROTATOR ELIMINATORS					
RE200	7.4L (454ci) Also LPG	Rotator Eliminator	1.7400	0.640	0.350
RE200I	7.4L (454ci) Also LPG	Rotator Eliminator	1.7400	0.640	0.180
RE250	7.4L (454ci) Also LPG	Rotator Eliminator	1.7400	0.640	0.250
RE200HP	7.4L (454ci) Hi Perf.	Rotator Eliminator (Cupped)	1.7400	0.640	0.300
SPRING RETAINERS					
SR-220	2.2L (134ci)	Spring Retainer	Valve Stem Diameter 0.234/0.235		
SR-500	5.7L (350ci) Hi Perf.	Spring Retainer	Valve Stem Diameter 0.341/0.342		
SR-366	7.4L (454ci)	Spring Retainer	Valve Stem Diameter 0.372		
SEAL HOUSING BOLTS					
AB-002-P	4.3L (262ci), 5.0L (305ci), 5.7L (350ci)	Bolt	1/4-20 x 1-3/4 Machine Screw, Torx		
AB-003-P	4.3L (262ci), 5.0L (305ci), 5.7L (350ci)	Bolt	1/4-20 x 7/8 Machine Screw, Torx		
SEAL HOUSING DOWELS					
AD-026	3.8L	Hollow Dowel	0.4325	0.343	0.240
AD-003-P	4.3L (262ci), 5.0L (305ci), 5.7L (350ci)	Hollow Dowel	0.4445	0.297	0.562

ENGINE HARDWARE

PART NO.	MAKE & APPLICATION	PRODUCT TYPE	DIMENSION		
			O.D.	I.D.	LENGTH
GENERAL MOTORS (Cont'd)					
SPARK PLUG TUBES					
SPT-4	3.6L (High Feature Eng.)	Spark Plug Tube	N/A	N/A	4.370
THRUST PLATE BOLTS					
AB-004-P	4.3L (262ci)	Balance Shaft Thrust Plate Bolt	1/4-20 x 1/2 Machine Screw, Torx		
AB-006-P	4.3L (262ci)	Cam Thrust Plate Bolt	1/4-20 x 5/8 Machine Screw, Torx		
AB-004-P	4.3L (262ci), 5.0L (305ci), 5.7L (350ci) w/Roller Cam	Cam Thrust Plate Bolt	1/4-20 x 1/2 Machine Screw, Torx		
AB-004-P	5.0L (305ci), 5.7L (350ci) w/Roller Cam	Water Pump Shaft Thrust Plate Bolt	1/4-20 x 1/2 Machine Screw, Torx		
AB-001-P	(265ci-455ci) Pontiac V8	Cam Thrust Plate Bolt	5/16-18 x 3/4 Hex		
TIMING COVER BOLTS					
AB-017-P	(262ci-400ci) Small Block V8	Timing Cover Bolt (Steel Cover)	1/4-20 x 1/2 Frame Bolt, Hex		
TIMING COVER DOWELS					
AD-016-P	2.2L (134ci)	Solid Dowel	0.2326	Solid	0.645
AD-046	4.3L (1996-2003) w/Plastic Timing Cover	Solid Dowel (Middle Stepped)	0.2483 / .3435	Solid	0.945
AD-1284-P	(262ci-400ci) Small Block V8, (366ci-454ci) Big Block V8	Solid Dowel	0.2466	Solid	0.630
AD-012-P	6.2L, 6.5L Diesel	Solid Dowel	9mm	Solid	22mm
TIMING GEAR OILER					
TC-4	2.5L (151ci), 3.8L (230ci), 4.1L (250ci), 4.8L (292ci)	Timing Gear Oiler (Press in Type)	N/A	N/A	N/A
TIMING STUDS & NUTS					
ST-045-P	4.3L (262ci)	Timing Stud	5/16-18 x 1-3/4		
AN-001-P	4.3L (262ci)	Timing Stud Nut	5/16-18 Top Lock Nut, Hex		
TRANSMISSION DOWELS					
AD-076	2.5L, 2.8L, 3.0L, 3.1L, 3.8L	Hollow Dowel	0.7275	0.500	0.750
AD-009-P	All Other GM V6 / V8	Solid Dowel	0.6210	Solid	1.150
AD-023	All Other GM V6 / V8 Hi Perf.	Solid Dowel	0.6210	Solid	1.550
WOODRUFF KEYS					
AK-003-P	4.3L (262ci)	Woodruff Key	3/16 x 1-13/32		
AK-002-P	(262ci-400ci) Small Block V8, (366ci-454ci) Big Block V8 (265ci-455ci) Pontiac V8	Woodruff Key	3/16 x 3/4		
AK-001-P	(262ci-400ci) Small Block V8, (265ci-455ci) Pontiac V8	Woodruff Key	3/16 x 1-3/8		
AK-032-P	4.8L, 5.3L, 6.0L Gen III	Woodruff Key	3/16 x 1-31/64		
AK-166-P	7.4L (454ci)	Woodruff Key	3/16 x 2.367		
ISUZU					
HEAD DOWELS					
AD-002	2.3L	Hollow Dowel	0.5825	0.500	0.355
AD-021	Isuzu	Hollow Dowel	11mm	8.5mm	8.3mm
JEEP					
MANIFOLD DOWELS					
AD-242	4.0L	Solid Dowel	0.4250	Solid	0.685
MAZDA					
HEAD PLUGS					
AP-020	MZR Eng.	Aluminum Plug	0.3645	Solid	0.360
REAR MAIN DOWELS					
AD-SS	2.2L	Hollow Dowel	0.3546	0.266	0.390

ENGINE HARDWARE

PART NO.	MAKE & APPLICATION	PRODUCT TYPE	DIMENSION		
			O.D.	I.D.	LENGTH
MITSUBISHI					
CAM SPROCKET DOWELS					
AD-402	SOHC 2.2L, 2.5L Vin A-E, J, K.	Solid Dowel	0.2318	Solid	0.630
HEAD DOWELS					
AD-111	2.0L, 2.4L, 2.6L	Hollow Dowel	0.6300	0.500	0.505
AD-402	2.2L, 2.5L SOHC Vin A-E, J, K.	Solid Dowel	0.2318	Solid	0.630
AD-849	2.4L, 2.6L G54B 2.7L	Hollow Dowel	0.6310	0.500	0.485
AD-856	3.3L (202ci) Chrysler	Hollow Dowel	0.5913	0.452	0.488
HEAD PLUGS					
AP-019	Multiple Engines	Aluminum Plug	0.3250	Solid	0.240
TRANSMISSION DOWELS					
AD-849	2.4L, 2.6L G54B 2.7L	Hollow Dowel	0.6310	0.500	0.485
AD-021	2.4L, 2.7L, 3.3L	Hollow Dowel	11mm	8.5mm	8.3mm
NISSAN					
CAM TOWER DOWELS					
AD-100	Nissan	Hollow Dowel	0.4320	0.336	0.432
HEAD DOWELS					
AD-M00	1.6L, E16 Eng.	Hollow Dowel	0.5320	0.469	0.442
AD-400	1.6L (L16), 1.8L (L18), 2.0L (L20 & Z20), 2.2L (9Z22), 2.4L (L24 & Z24), 2.6L (L26), 2.8L (L28) L, Z Series	Hollow Dowel	0.5540	0.437	0.412
AD-V00	3.0L VG30 Eng.	Solid Dowel Pin	0.3750	Solid	0.570
HEAD PLUGS					
AP-018	QR25DE Eng.	Aluminum Plug	0.2200	Solid	0.180
AP-019	Multiple Engines	Aluminum Plug	0.3250	Solid	0.240
SPRING RETAINERS					
SR-809	2.5L QR25	Spring Retainer	Valve Stem Diameter 0.235		
SATURN					
HEAD DOWELS					
AD-634	1.9L	Hollow Dowel	0.5155	0.437	0.665
TRANSMISSION DOWELS					
AD-635	1.9L	Hollow Dowel	0.6080	0.500	0.905
SUBARU					
BLOCK MATING DOWELS					
AD-027	2.5L EJ25 Eng.	Hollow Dowel	0.4723	0.348	1.030
SUZUKI					
HEAD DOWELS					
AD-189	1.3L, 1.6L G13, G16 Eng.	Hollow Dowel	0.5113	0.406	0.700
AD-347	Suzuki	Hollow Dowel	0.3900	0.281	0.272
OIL PUMP DOWELS					
AD-SS	1.3L	Hollow Dowel	0.3546	0.266	0.390
REAR MAIN DOWELS					
AD-SS	1.3L	Hollow Dowel	0.3546	0.266	0.390

ENGINE HARDWARE

PART NO.	MAKE & APPLICATION	PRODUCT TYPE	DIMENSION		
			O.D.	I.D.	LENGTH
TOYOTA					
CAM CAP/TOWER DOWELS					
AD-021	1.8L, 2.0L, 2.2L, 18R, 20R, 22R Blocks	Hollow Dowel	11mm	8.5mm	8.3mm
AD-394	1MZ-FE/3MZ-FE Eng.	Hollow Dowel	0.3940	0.294	0.322
COOLANT TUBES					
TC-5	1MZ Eng.	Coolant Tube	0.8725	0.777	3.490
HEAD DOWELS					
AD-017	1.6L (1587cc) SOHC 4AC Eng.	Hollow Dowel	0.5113	0.422	0.470
AD-8120-P	2.4L, 20R, 22R, 22RE, 22REC, 22RTEC Blocks	Solid Dowel	0.3150	Solid	0.705
AD-001	3.0L (2958cc) SOHC 3VZE Eng.	Hollow Dowel	0.6290	0.453	0.785
OIL GALLEY PLUGS					
AP-004-P	2.4L, 20R, 22R, 22RE, 22REC, 22RTEC Blocks	Oil Galley Plug	1/8-28 x .56 External Hex, w/Sealant		
AP-005-P	2.4L, 20R, 22R, 22RE, 22REC, 22RTEC Blocks	Oil Galley Plug	1/4-19 x .39 Internal Hex, w/Sealant		
AP-006-P	2.4L, 20R, 22R, 22RE, 22REC, 22RTEC Blocks	Oil Galley Plug	3/8-19 x .39 Internal Hex, w/Sealant		
PLANETARY SLEEVES					
U140-190	All U Series Transmissions	Planetary Sleeve	0.5620	0.3780/0.3785	0.190
U140-250	All U Series Transmissions	Planetary Sleeve	0.5620	0.3780/0.3785	0.250
REAR MAIN DOWELS					
AD-021	1.8L, 2.0L, 2.2L, 18R, 20R, 22R Blocks	Hollow Dowel	11mm	8.5mm	8.3mm
ROCKER ASSEMBLY DOWELS					
AD-020	2.4L (2366cc) SOHC Toyota 22RE, REC Eng.	Hollow Dowel	0.6095	0.484	0.636
SPARK PLUG TUBES					
SPT-2	1MZ Eng.	Spark Plug Tube	1.0275	0.965	3.755
SPT-3	5VZ Eng.	Spark Plug Tube	1.0275	0.965	4.025
SPT-5	5SFE Eng.	Spark Plug Tube	1.1040	0.950	4.325
TENSIONER BOLTS & WASHERS					
AW-012-P	2.4L, 20R, 22R, 22RE, 22REC, 22RTEC Blocks	Lock Washer	8mm Lock Washer		
TIMING COVER DOWELS					
AD-021	1.8L, 2.0L, 2.2L, 2.4L, 18R, 20R, 22R, 22RE, 22REC, 22RTEC Blocks	Hollow Dowel	11mm	8.5mm	8.3mm
TRANSMISSION DOWELS					
AD-0113	2.4L, 20R, 22R, 22RE, 22REC, 22RTEC Blocks	Solid Dowel	10mm	Solid	22mm
WATER PLUGS					
AP-006-P	2.4L, 20R, 22R, 22RE, 22REC, 22RTEC Blocks	Water Plug	3/8-19 x .39 Internal Hex, w/Sealant		
WATER PUMP DOWELS					
AD-021	1.8L, 2.0L, 2.2L, 18R, 20R, 22R Blocks	Hollow Dowel	11mm	8.5mm	8.3mm
WOODRUFF KEYS					
AK-011-P	2.4L, 20R, 22R, 22RE, 22REC, 22RTEC Blocks	Woodruff Key	5mm x 18mm		
WAUKESHA					
EXPANSION PLUGS					
DP-22-P	3.6L (220ci) VRD220, VRD220S, VRG220	Expansion Plug	2-1/4 Disc Plug		
SPRING RETAINERS					
SR-014	VGF F18/H24GL/GLD LCR/HCR, L36/P48GL/GLD HCR	Spring Retainer	Valve Stem Diameter 0.430/0.431		

ENGINE HARDWARE COMPONENT LISTING

Bolt - Specifications

Size	
PART #	DIMENSION
AB-017-P	1/4-20 x 1/2 Frame Bolt, Hex
AB-004-P	1/4-20 x 1/2 Machine Screw, Torx
AB-011-P	1/4-20 x 1/2 Place Bolt, Hex
AB-024-P	1/4-20 x 1/2 Sims Bolt, Hex
AB-010-P	1/4-20 x 5/8 Hex
AB-006-P	1/4-20 x 5/8 Machine Screw, Torx
AB-016-P	1/4-20 x 3/4 Frame Bolt, Hex
AB-003-P	1/4-20 x 7/8 Machine Screw, Torx
AB-002-P	1/4-20 x 1-3/4 Machine Screw, Torx
AB-005-P	5/16-18 x 5/8 Flanged Hex
AB-023-P	5/16-18 x 5/8 Sims Bolt, Hex
AB-001-P	5/16-18 x 3/4 Hex
AB-020-P	5/16-18 x 7/8 Frame Bolt, Hex
AB-039-P	5/16-18 x 1-1/16
AB-007-P	5/16-18 x 1-3/8 Cap Screw, Hex
AB-019-P	5/16-18 x 1-1/2 Hex
AB-042-P	3/8-16 x 3/4 Hex
AB-021-P	3/8-16 x 5/8 Hex
AB-026-P	3/8-16 x 1-1/4 Bolt, Hex
AB-014-P	3/8-16 x 1-3/8 Hex
AB-009-P	3/8-16 x 1-1/2 Hex
AB-015-P	7/16-14 x 5/8 Hex
AB-040-P	7/16-14 x 1 Hex
AB-012-P	7/16-14 x 1-1/4 Hex
AB-013-P	7/16-14 x 1-3/4 Hex
AB-022-P	7/16-14 x 2 Bolt, Hex
AB-018-P	7/16-14 x 2-1/4 Bolt, Hex
AB-031-P	1/2-20 x 1 Hex
AB-030-P	1/2-20 x 1-1/4 Hex
AB-027-P	15/16-18 x 1/2 Hex
AB-034-P	6mm-1.0 x 14mm Hex
AB-033-P	6mm-1.0 x 19mm Flat Head Torx
AB-032-P	10mm-1.5 x 34mm Hex, 35mm Integral Washer

Numerical	
PART #	DIMENSION
AB-001-P	5/16-18 x 3/4 Hex
AB-002-P	1/4-20 x 1-3/4 Machine Screw, Torx
AB-003-P	1/4-20 x 7/8 Machine Screw, Torx
AB-004-P	1/4-20 x 1/2 Machine Screw, Torx
AB-005-P	5/16-18 x 5/8 Flanged Hex
AB-006-P	1/4-20 x 5/8 Machine Screw, Torx
AB-007-P	5/16-18 x 1-3/8 Cap Screw, Hex
AB-009-P	3/8-16 x 1-1/2 Hex
AB-010-P	1/4-20 x 5/8 Hex
AB-011-P	1/4-20 x 1/2 Place Bolt, Hex
AB-012-P	7/16-14 x 1-1/4 Hex
AB-013-P	7/16-14 x 1-3/4 Hex
AB-014-P	3/8-16 x 1-3/8 Hex
AB-015-P	7/16-14 x 5/8 Hex
AB-016-P	1/4-20 x 3/4 Frame Bolt, Hex
AB-017-P	1/4-20 x 1/2 Frame Bolt, Hex
AB-018-P	7/16-14 x 2-1/4 Bolt, Hex
AB-019-P	5/16-18 x 1-1/2 Hex
AB-020-P	5/16-18 x 7/8 Frame Bolt, Hex
AB-021-P	3/8-16 x 5/8 Hex
AB-022-P	7/16-14 x 2 Bolt, Hex
AB-023-P	5/16-18 x 5/8 Sims Bolt, Hex
AB-024-P	1/4-20 x 1/2 Sims Bolt, Hex
AB-026-P	3/8-16 x 1-1/4 Bolt, Hex
AB-027-P	15/16-18 x 1/2 Hex
AB-030-P	1/2-20 x 1-1/4 Hex
AB-031-P	1/2-20 x 1 Hex
AB-032-P	10mm-1.5 x 34mm Hex, 35mm Integral Washer
AB-033-P	6mm-1.0 x 19mm Flat Head Torx
AB-034-P	6mm-1.0 x 14mm Hex
AB-039-P	5/16-18 x 1-1/16
AB-040-P	7/16-14 x 1 Hex
AB-042-P	3/8-16 x 3/4 Hex

Dowel Pin - Specifications

Size			
PART #	O.D.	I.D.	LENGTH
AD-402	0.2318	Solid	0.630
AD-016-P	0.2326	Solid	0.645
AD-1284-P	0.2466	Solid	0.630
AD-046	0.2483 / 0.3435	Solid	0.945
AD-6397	0.2485 / 0.3140	Solid	0.700
AD-025-P	0.2500	Solid	0.500
AD-006-P	0.3090	Solid	1.500
AD-005-P	0.3115	Solid	1.125
AD-004-P	0.3115	Solid	1.375
AD-927-P	0.3125	Solid	0.565
AD-015	0.3140	0.261	0.455
AD-8120-P	0.3150	Solid	0.705
AD-SS	0.3546	0.266	0.390
AD-V00	0.3750	Solid	0.570
AD-347	0.3900	0.281	0.272
AD-024	0.3937	0.328	0.627
AD-394	0.3940	0.294	0.322

Numerical			
PART #	O.D.	I.D.	LENGTH
AD-001	0.6290	0.453	0.785
AD-002	0.5825	0.500	0.355
AD-003-P	0.4445	0.297	0.562
AD-004-P	0.3115	Solid	1.375
AD-005-P	0.3115	Solid	1.125
AD-006-P	0.3090	Solid	1.500
AD-008-P	0.6745	0.552	0.435
AD-008A-P	0.7400	0.625	0.445
AD-009-P	0.6210	Solid	1.150
AD-010-P	0.6120	0.466	0.600
AD-011-P	17mm	15mm	19mm
AD-0112	0.6250 / 0.5620	0.450	0.500
AD-0113	10mm	Solid	22mm
AD-012-P	9mm	Solid	22mm
AD-013	0.5820	0.484	0.945
AD-015	0.3140	0.261	0.455
AD-016-P	0.2326	Solid	0.645

ENGINE HARDWARE COMPONENT LISTING

Dowel Pin - Specifications (Cont'd)

Size				Numerical			
PART #	O.D.	I.D.	LENGTH	PART #	O.D.	I.D.	LENGTH
AD-242	0.4250	Solid	0.685	AD-017	0.5113	0.422	0.470
AD-100	0.4320	0.336	0.432	AD-018	0.5820 / 0.5910	0.484	0.945
AD-026	0.4325	0.343	0.240	AD-020	0.6095	0.484	0.636
AD-022	0.4350	0.343	0.500	AD-021	11mm	8.5mm	8.3mm
AD-679	0.4386	Solid	0.813	AD-022	0.4350	0.343	0.500
AD-003-P	0.4445	0.297	0.562	AD-023	0.6210	Solid	1.550
AD-027	0.4723	0.348	1.030	AD-024	0.3937	0.328	0.627
AD-967	0.4820	0.385	0.550	AD-025-P	0.2500	Solid	0.500
AD-520	0.4881	0.400	0.670	AD-026	0.4325	0.343	0.240
AD-532	0.4960	Solid	0.740	AD-027	0.4723	0.348	1.030
AD-397	0.5000	Solid	1.000	AD-046	0.2483 / 0.3435	Solid	0.945
AD-E7RY	0.5010	0.406	0.650	AD-050	0.5562	0.500	0.745
AD-189	0.5113	0.406	0.700	AD-076	0.7275	0.500	0.750
AD-017	0.5113	0.422	0.470	AD-100	0.4320	0.336	0.432
AD-634	0.5155	0.437	0.665	AD-111	0.6300	0.500	0.505
AD-M00	0.5320	0.469	0.442	AD-148	0.5615	0.454	0.812
AD-270	0.5510	0.410	0.485	AD-189	0.5113	0.406	0.700
AD-400	0.5540	0.437	0.412	AD-230	0.7200	0.615	0.395
AD-300	0.5555	0.468	0.470	AD-242	0.4250	Solid	0.685
AD-050	0.5562	0.500	0.745	AD-250	0.7600	0.640	0.635
AD-148	0.5615	0.454	0.812	AD-258	0.6250	0.523	0.500
AD-013	0.5820	0.484	0.945	AD-270	0.5510	0.410	0.485
AD-018	0.5820 / 0.5910	0.484	0.945	AD-300	0.5555	0.468	0.470
AD-002	0.5825	0.500	0.355	AD-326	0.6420	0.516	0.500
AD-856	0.5913	0.452	0.488	AD-347	0.3900	0.281	0.272
AD-600	0.6050	0.475	0.550	AD-352	0.6165	0.500	1.100
AD-521	0.6074	0.510	0.800	AD-394	0.3940	0.294	0.322
AD-635	0.6080	0.500	0.905	AD-397	0.5000	Solid	1.000
AD-020	0.6095	0.484	0.636	AD-397A	0.6305	0.469	0.984
AD-010-P	0.6120	0.466	0.600	AD-400	0.5540	0.437	0.412
AD-352	0.6165	0.500	1.100	AD-402	0.2318	Solid	0.630
AD-009-P	0.6210	Solid	1.150	AD-520	0.4881	0.400	0.670
AD-023	0.6210	Solid	1.550	AD-521	0.6074	0.510	0.800
AD-258	0.6250	0.523	0.500	AD-532	0.4960	Solid	0.740
AD-0112	0.6250 / 0.5620	0.450	0.500	AD-600	0.6050	0.475	0.550
AD-001	0.6290	0.453	0.785	AD-605	1.4985	1.092	1.075
AD-111	0.6300	0.500	0.505	AD-634	0.5155	0.437	0.665
AD-397A	0.6305	0.469	0.984	AD-635	0.6080	0.500	0.905
AD-849	0.6310	0.500	0.485	AD-6397	0.2485 / 0.3140	Solid	0.700
AD-8081-P	0.6400	0.500	0.500	AD-679	0.4386	Solid	0.813
AD-326	0.6420	0.516	0.500	AD-699	1.4985	0.830	0.924
AD-008-P	0.6745	0.552	0.435	AD-842	0.7570	0.491	1.160
AD-230	0.7200	0.615	0.395	AD-849	0.6310	0.500	0.485
AD-076	0.7275	0.500	0.750	AD-856	0.5913	0.452	0.488
AD-008A-P	0.7400	0.625	0.445	AD-927-P	0.3125	Solid	0.565
AD-842	0.7570	0.491	1.160	AD-967	0.4820	0.385	0.550
AD-250	0.7600	0.640	0.635	AD-1284-P	0.2466	Solid	0.630
FD-1-1	0.9395	0.834	0.572	AD-8081-P	0.6400	0.500	0.500
AD-699	1.4985	0.830	0.924	AD-8120-P	0.3150	Solid	0.705
AD-605	1.4985	1.092	1.075	AD-E7RY	0.5010	0.406	0.650
AD-012-P	9mm	Solid	22mm	AD-M00	0.5320	0.469	0.442
AD-0113	10mm	Solid	22mm	AD-SS	0.3546	0.266	0.390
AD-021	11mm	8.5mm	8.3mm	AD-V00	0.3750	Solid	0.570
AD-011-P	17mm	15mm	19mm	FD-1-1	0.9395	0.834	0.572

ENGINE HARDWARE COMPONENT LISTING

Pipe Plug - Specifications

Size	
PART #	DIMENSION
AP-001-P	1/16-27 x 1/4 Internal Hex
AP-004-P	1/8-28 x .56 External Hex, w/Sealant
AP-002-P	1/4-18 x .33 Internal Hex, w/Sealant
AP-017-P	1/4-18 x .33 Internal Hex
AP-016-P	1/4-18 x .37 Internal Hex
AP-005-P	1/4-19 x .39 Internal Hex, w/Sealant
AP-003-P	3/8-18 x .46 Internal Hex, w/Sealant
AP-006-P	3/8-19 x .39 Internal Hex, w/Sealant

Numerical	
PART #	DIMENSION
AP-001-P	1/16-27 x 1/4 Internal Hex
AP-002-P	1/4-18 x .33 Internal Hex, w/Sealant
AP-003-P	3/8-18 x .46 Internal Hex, w/Sealant
AP-004-P	1/8-28 x .56 External Hex, w/Sealant
AP-005-P	1/4-19 x .39 Internal Hex, w/Sealant
AP-006-P	3/8-19 x .39 Internal Hex, w/Sealant
AP-016-P	1/4-18 x .37 Internal Hex
AP-017-P	1/4-18 x .33 Internal Hex

Valve Spring ID Locators - Specifications

Size			
PART #	O.D.	I.D.	THICKNESS
4785HP	1.550	.570 / Spring(.810)	0.060

Numerical			
PART #	O.D.	I.D.	THICKNESS
4785HP	1.550	.570 / Spring(.810)	0.060

Valve Spring Retainers - Specifications

Size		
PART #	VALVE STEM DIAMETER	DIMENSION OUTSIDE/STEPS
SR-220	0.234/0.235	0.982/0.590/0.484
SR-809	0.235	0.962/0.697/0.491
SR-570	0.272/0.273	0.897/0.594/0.544
SR-626	0.311/0.312	1.144/0.830/0.562
SR-627	0.311/0.312	1.144/0.828/0.572
SR-779	0.315	1.080/0.750/0.612
SR-536	0.315/0.316	1.275/0.958/0.570
SR-183	0.316	1.310/0.873/0.760
SR-500	0.341/0.342	1.236/0.862/0.675
SR-502	0.342	1.370/1.056/0.665
SR-318	0.370/0.373	1.330/1.000/0.600
SR-366	0.372	1.407/1.058/0.900
SR-014	0.430/0.431	1.570/1.207/0.840

Numerical		
PART #	VALVE STEM DIAMETER	DIMENSION OUTSIDE/STEPS
SR-014	0.430/0.431	1.570/1.207/0.840
SR-183	0.316	1.310/0.873/0.760
SR-220	0.234/0.235	0.982/0.590/0.484
SR-318	0.370/0.373	1.330/1.000/0.600
SR-366	0.372	1.407/1.058/0.900
SR-500	0.341/0.342	1.236/0.862/0.675
SR-502	0.342	1.370/1.056/0.665
SR-536	0.315/0.316	1.275/0.958/0.570
SR-570	0.272/0.273	0.897/0.594/0.544
SR-626	0.311/0.312	1.144/0.830/0.562
SR-627	0.311/0.312	1.144/0.828/0.572
SR-779	0.315	1.080/0.750/0.612
SR-809	0.235	0.962/0.697/0.491

ENGINE HARDWARE COMPONENT LISTING

Washer - Specifications

Size		Numerical	
PART #	DIMENSION	PART #	DIMENSION
AW-009-P	5/16 Star Washer	AW-001-P	1-1/4 x 3/8 x 1/4 Washer
AW-007-P	3/8 Washer	AW-002-P	1-1/2 x 7/16 x 5/16 Washer
AW-008-P	1/2 x .900 x .078 Nylon Washer	AW-003-P	1-1/4 x 7/16 x 1/4 Washer
AW-001-P	1-1/4 x 3/8 x 1/4 Washer	AW-005-P	1-1/2 x 7/16 x 7/16 Washer
AW-003-P	1-1/4 x 7/16 x 1/4 Washer	AW-006-P	1-1/2 x 7/16 x 1/8 Washer
AW-010-P	1-3/8 x 1/2 x 3/16 Washer	AW-007-P	3/8 Washer
AW-006-P	1-1/2 x 7/16 x 1/8 Washer	AW-008-P	1/2 x .900 x .078 Nylon Washer
AW-002-P	1-1/2 x 7/16 x 5/16 Washer	AW-009-P	5/16 Star Washer
AW-005-P	1-1/2 x 7/16 x 7/16 Washer	AW-010-P	1-3/8 x 1/2 x 3/16 Washer
AW-011-P	2-1/16 x 1/2 x 3/16 Washer	AW-011-P	2-1/16 x 1/2 x 3/16 Washer
AW-012-P	8mm Lock Washer	AW-012-P	8mm Lock Washer

Woodruff Key - Specifications

Size			Numerical		
PART #	WIDTH X LENGTH	PIONEER #	PART #	WIDTH X LENGTH	PIONEER #
AK-024-P	3/32 x 1/2	PK-2	AK-001-P	3/16 x 1-3/8	PK-126
AK-019-P	3/32 x 5/8	PK-4	AK-002-P	3/16 x 3/4	PK-9
AK-017-P	1/8 x 3/4	PK-7	AK-003-P	3/16 x 1-13/32	PK-131
AK-015-P	5/32 x 5/8	PK-6	AK-004-P	3/16 x 1-3/4	PK-130
AK-018-P	5/32 x 3/4	PK-8	AK-005-P	3/16 x 1-13/16	PK-178, 192
AK-025-P	5/32 x 7/8	PK-10	AK-006-P	3/16 x 1-13/32	PK-134
AK-031-P	3/16 x 19/32	PK-187	AK-007-P	3/16 x 1-3/4	PK-135
AK-002-P	3/16 x 3/4	PK-9	AK-008-P	1/4 x 55/64	PK-174
AK-010-P	3/16 x 7/8	PK-11	AK-010-P	3/16 x 7/8	PK-11
AK-026-P	3/16 x 1	PK-13	AK-011-P	5mm x 18mm	NA
AK-028-P	3/16 x 1-3/64	PK-179	AK-012-P	15/64 x 23/32	PK-171
AK-001-P	3/16 x 1-3/8	PK-126	AK-013-P	5/16 x 1-7/64	PK-175
AK-003-P	3/16 x 1-13/32	PK-131	AK-014-P	1/4 x 1-3/8	PK-127
AK-006-P	3/16 x 1-13/32	PK-134	AK-015-P	5/32 x 5/8	PK-6
AK-032-P	3/16 x 1-31/64	NA	AK-016-P	5/16 x 31/32	PK-173
AK-004-P	3/16 x 1-3/4	PK-130	AK-017-P	1/8 x 3/4	PK-7
AK-007-P	3/16 x 1-3/4	PK-135	AK-018-P	5/32 x 3/4	PK-8
AK-005-P	3/16 x 1-13/16	PK-178, 192	AK-019-P	3/32 x 5/8	PK-4
AK-166-P	3/16 X 2.367	NA	AK-020-P	1/4 x 1-1/4	PK-21
AK-029-P	13/64 x 39/64	PK-188	AK-021-P	3/8 x 2-1/8	PK-29
AK-030-P	13/64 x 45/64	PK-189	AK-022-P	1/4 x 3/4	PK-91
AK-012-P	15/64 x 23/32	PK-171	AK-023-P	5/16 x 1-1/4	PK-D
AK-022-P	1/4 x 3/4	PK-91	AK-024-P	3/32 x 1/2	PK-2
AK-008-P	1/4 x 55/64	PK-174	AK-025-P	5/32 x 7/8	PK-10
AK-027-P	1/4 x 1	PK-15	AK-026-P	3/16 x 1	PK-13
AK-020-P	1/4 x 1-1/4	PK-21	AK-027-P	1/4 x 1	PK-15
AK-014-P	1/4 x 1-3/8	PK-127	AK-028-P	3/16 x 1-3/64	PK-179
AK-016-P	5/16 x 31/32	PK-173	AK-029-P	13/64 x 39/64	PK-188
AK-013-P	5/16 x 1-7/64	PK-175	AK-030-P	13/64 x 45/64	PK-189
AK-023-P	5/16 x 1-1/4	PK-D	AK-031-P	3/16 x 19/32	PK-187
AK-021-P	3/8 x 2-1/8	PK-29	AK-032-P	3/16 x 1-31/64	NA
AK-011-P	5mm x 18mm	NA	AK-166-P	3/16 X 2.367	NA

Does This Look Familiar?



Well, Dura-Bond Has The Solution For You.

Save time and money with the new line of Dura-Bond engine hardware finishing kits.

Most rebuilders know the time and expense of trying to reclaim service parts. A recent study revealed that an average rebuilder could spend up to 15-20 minutes per engine searching for a reclaimed service part. That is why Dura-Bond has introduced a new line of engine hardware finishing kits. These kits include all of the necessary hardware and components needed to complete a rebuild such as dowel pins, cam bolts, seal housing components, woodruff keys, cam eccentrics, by-pass valves, etc. The engine hardware finishing kits allow rebuilders an easy way to inventory and recoup lost costs on these components. All this adds up to saving time and money.



- No need for expensive OEM parts or the time to reclaim used parts
- Easy to inventory
- Maximize lost costs and profits on these components by adding one part number into the bill of materials
- New parts vs. reclaimed parts presents a more professional looking product
- All kit components are manufactured to precise OEM dimensions for exact fit
- Extensive product coverage

Dura-Bond®

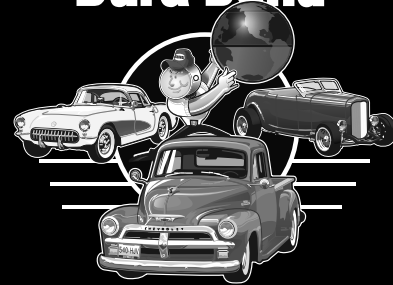

A MELLING COMPANY

3200 Arrowhead Drive, Carson City, NV 89706 • 1-800-227-8360 • www.dura-bondbearing.com

ENGINE HARDWARE FINISHING KITS

KIT NO.	YEAR	MAKE & APPLICATION	CONTENTS	QTY.	DESCRIPTION	DIMENSION					
						O.D.	I.D.	LENGTH			
AMC											
FKA-1	1964-1996	(199ci-258ci) AMC I6	AD-927-P	2	Head Dowel	0.3125	Solid	0.565			
			AB-030-P	1	Cam Bolt	1/2-20 x 1-1/4 Hex					
			AW-011-P	1	Cam Bolt Washer	2-1/16 x 1/2 x 3/16 Washer					
			AK-002-P	2	Woodruff Key	3/16 x 3/4					
			AK-010-P	2	Woodruff Key	3/16 x 7/8					
			AD-007-P	1	Oil Filter Pin (Roll Pin)	1/4 x 1-1/2					
			Optional parts not included in kit.								
			AD-148	2	Transmission Dowel	0.5615	0.454	0.812			
			CHRYSLER								
FKP-1	1964-2005	(273ci-360ci) Dodge/Chrysler/ Plymouth SB V8	AD-927-P	4	Head Dowel	0.3125	Solid	0.565			
			AB-012-P	1	Cam Bolt	7/16-14 x 1-1/4 Hex					
			AW-002-P	1	Cam Bolt Washer (Cupped)	1-1/2 x 7/16 x 5/16 Washer					
			AK-005-P	1	Woodruff Key	3/16 x 1-13/16					
			AK-002-P	1	Cam Key	3/16 x 3/4					
			AB-001-P	3	Cam Thrust Plate Bolt	5/16-18 x 3/4 Hex					
			AS-001-P	1	Chain Oil Tab	N/A	N/A	N/A			
			AD-584	1	Distributor Tower Shaft Bushing	N/A	N/A	N/A			
			ROLLER BLOCK								
			AB-005-P	3	Cam Tray Bolt	5/16-18 x 5/8 Flanged Hex					
			AW-006-P	1	Cam Bolt Washer (Tapered)	1-1/2 x 7/16 x 1/8 Washer					
			AW-005-P	1	Cam Bolt Washer (Cupped)	1-1/2 x 7/16 x 7/16 Washer					
			Optional parts not included in kit.								
			AD-532	2	Transmission Dowel	0.4960	Solid	0.740			
			FKP-2		(361ci-440ci) Dodge/Chrysler/ Plymouth SB V8	AD-1284-P	4	Head Dowel	0.2466	Solid	0.630
AD-1284-P	2	Timing Cover				0.2466	Solid	0.630			
AB-040-P	1	Cam Bolt				7/16-14 x 1 Hex					
AW-006-P	1	Cam Bolt Washer (Tapered)				1-1/2 x 7/16 x 1/8 Washer					
AD-584	1	Distributor Tower Shaft Bushing				N/A	N/A	N/A			
AK-005-P	1	Woodruff Key				3/16 x 1-13/16					
Optional parts not included in kit.											
AD-532	2	Transmission Dowel				0.4960	Solid	0.740			
FKP-2HP		(361ci-440ci) Dodge/Chrysler/ Plymouth SB V8 (High Performance)				AD-1284-P	4	Head Dowel	0.2466	Solid	0.630
						AD-1284-P	2	Timing Cover	0.2466	Solid	0.630
			AB-040-P	1	Cam Bolt	7/16-14 x 1 Hex					
			AW-006-P	1	Cam Bolt Washer (Tapered)	1-1/2 x 7/16 x 1/8 Washer					
			AB-042-P	3	Cam Bolt	3/8-16 x 3/4 Hex					
			AD-584	1	Distributor Tower Shaft Bushing	N/A	N/A	N/A			
			AK-005-P	1	Woodruff Key	3/16 x 1-13/16					
			Optional parts not included in kit.								
			AD-532	2	Transmission Dowel	0.4960	Solid	0.740			
			FORD								
FKF-5	1989-1993	3.8L (232ci) Ford V6	AD-011-P	4	Head Dowel (Split)	17mm	15mm	19mm			
			AD-520	2	Timing Cover Dowel	0.4881	0.400	0.670			
			AB-032-P	1	Cam Bolt & Washer	10mm-1.5 x 34mm Hex, 35mm Integral Washer					
			AB-033-P	2	Cam Thrust Plate Bolt	6mm-1.0 x 19mm Flat Head Torx					
			AB-034-P	3	Tensioner Bolt	6mm-1.0 x 14mm Hex					
			AK-003-P	1	Woodruff Key	3/16 x 1-13/32					
			BALANCE SHAFT								
			AB-033-P	2	Balance Shaft Thrust Plate Bolt	6mm-1.0 x 19mm Flat Head Torx					
			Optional parts not included in kit.								
			AD-397	2	Transmission Dowel RWD	0.5000	Solid	1.000			
			AD-521	2	Transmission Dowel FWD	0.6074	0.510	0.800			
FKF-4	1965-1996	(240ci, 300ci) Ford I6	AD-008-P	2	Head Dowel	0.6745	0.552	0.435			
			AB-001-P	2	Cam Thrust Plate Bolt	5/16-18 x 3/4 Hex					
			AK-004-P	1	Woodruff Key	3/16 x 1-3/4					
			AK-002-P	1	Cam Key	3/16 x 3/4					
			AS-002	1	Spacer	1.5160	1.255	0.194			
			AP-001-P	1	Oil Galley Plug	1/16-27 x 1/4 Internal Hex					
			Optional parts not included in kit.								
			AD-397	2	Transmission Dowel	0.5000	Solid	1.000			

ENGINE HARDWARE FINISHING KITS

KIT NO.	YEAR	MAKE & APPLICATION	CONTENTS	QTY.	DESCRIPTION	DIMENSION					
						O.D.	I.D.	LENGTH			
FORD (Cont'd)											
FKF-1	1962-1985	(255ci-351ci) Ford SB V8 (Windsor)	AD-008-P	4	Head Dowel	0.6745	0.552	0.435			
			AD-967-P	2	Timing Cover Dowel	0.4820	0.385	0.550			
			AB-009-P	1	Cam Bolt	3/8-16 x 1-1/2 Hex					
			AW-001-P	1	Cam Bolt Washer	1-1/4 x 3/8 x 1/4 Washer					
			AB-010-P	2	Cam Thrust Plate Bolt	1/4-20 x 5/8 Hex					
			AK-003-P	1	Woodruff Key	3/16 x 1-13/32					
			AK-004-P	1	Woodruff Key	3/16 x 1-3/4					
			AE-001-P	1	Cam Eccentric - Inner	N/A	N/A	N/A			
			AE-002-P	1	Cam Eccentric - Outer	N/A	N/A	N/A			
			AD-005-P	1	Cam Sprocket Dowel	0.3115	Solid	1.125			
			Optional parts not included in kit.								
			AD-397	2	Transmission Dowel	0.5000	Solid	1.000			
			FKF-1A	1986-2000	5.0L, 5.8L Ford SB V8	AD-008-P	4	Head Dowel	0.6745	0.552	0.435
AD-967-P	2	Timing Cover Dowel				0.4820	0.385	0.550			
AB-009-P	1	Cam Bolt				3/8-16 x 1-1/2 Hex					
AW-001-P	1	Cam Bolt Washer				1-1/4 x 3/8 x 1/4 Washer					
AB-010-P	2	Cam Thrust Plate Bolt				1/4-20 x 5/8 Hex					
AK-003-P	1	Woodruff Key				3/16 x 1-13/32					
AK-004-P	1	Woodruff Key				3/16 x 1-3/4					
AE-003-P	1	Cam Eccentric				N/A	N/A	N/A			
AD-004-P	1	Cam Sprocket Dowel				0.3115	Solid	1.375			
ROLLER BLOCK											
AB-011-P	2	Cam Tray Bolt				1/4-20 x 1/2 Place Bolt, Hex					
Optional parts not included in kit.											
AD-397	2	Transmission Dowel				0.5000	Solid	1.000			
FKF-2	1958-1976	(332ci-428ci) Ford FE V8	AD-008A-P	4	Head Dowel (Split)	0.7400	0.625	0.445			
			AB-013-P	1	Cam Bolt	7/16-14 x 1-3/4 Hex					
			AW-003-P	1	Cam Bolt Washer	1-1/4 x 7/16 x 1/4 Washer					
			AB-015-P	2	Cam Thrust Plate Bolt	7/16-14 x 5/8 Hex					
			AK-006-P	1	Woodruff Key	3/16 x 1-13/32					
			AE-004-P	1	Cam Eccentric - Inner	N/A	N/A	N/A			
			AE-002-P	1	Cam Eccentric - Outer	N/A	N/A	N/A			
			AD-006-P	1	Cam Sprocket Dowel	0.3090	Solid	1.500			
			Optional parts not included in kit.								
			AD-397	2	Transmission Dowel	0.5000	Solid	1.000			
			FKF-6	1970-1982	(351ci, 400ci) Ford (Cleveland/Modified)	AD-008-P	4	Head Dowel	0.6745	0.552	0.435
						AD-967-P	2	Timing Cover Dowel	0.4820	0.385	0.550
						AB-009-P	1	Cam Bolt	3/8-16 x 1-1/2 Hex		
AW-001-P	1	Cam Bolt Washer				1-1/4 x 3/8 x 1/4 Washer					
AB-010-P	2	Cam Thrust Plate Bolt				1/4-20 x 5/8 Hex					
AK-007-P	1	Woodruff Key				3/16 x 1-3/4					
AE-001-P	1	Cam Eccentric - Inner				N/A	N/A	N/A			
AE-002-P	1	Cam Eccentric - Outer				N/A	N/A	N/A			
AD-005-P	1	Cam Sprocket Dowel				0.3115	Solid	1.125			
AD-025-P	2	Manifold Dowel				0.2500	Solid	0.500			
Optional parts not included in kit.											
AD-397	2	Transmission Dowel				0.5000	Solid	1.000			
FKF-3	1968-1987	(370ci-460ci) Ford BB V8				AD-008A-P	4	Head Dowel (Split)	0.7400	0.625	0.445
			AB-009-P	1	Cam Bolt	3/8-16 x 1-1/2 Hex					
			AW-001-P	1	Cam Bolt Washer	1-1/4 x 3/8 x 1/4 Washer					
			AB-011-P	2	Cam Thrust Plate Bolt	1/4-20 x 1/2 Place Bolt, Hex					
			AK-007-P	1	Woodruff Key	3/16 x 1-3/4					
			AK-008-P	1	Woodruff Key	1/4 x 7/8					
			AE-001-P	1	Cam Eccentric - Inner	N/A	N/A	N/A			
			AE-002-P	1	Cam Eccentric - Outer	N/A	N/A	N/A			
			AD-005-P	1	Cam Sprocket Dowel	0.3115	Solid	1.125			
			Optional parts not included in kit.								
			AD-397	2	Transmission Dowel	0.5000	Solid	1.000			

ENGINE HARDWARE FINISHING KITS

KIT NO.	YEAR	MAKE & APPLICATION	CONTENTS	QTY.	DESCRIPTION	DIMENSION		
						O.D.	I.D.	LENGTH
FORD (Cont'd)								
FKF-3A	1988-1997	7.5L (460ci) Ford BB V8	AD-008A-P	4	Head Dowel (Split)	0.7400	0.625	0.445
			AB-014-P	1	Cam Bolt	3/8-16 x 1-3/8 Hex		
			AW-001-P	1	Cam Bolt Washer	1-1/4 x 3/8 x 1/4 Washer		
			AB-011-P	2	Cam Thrust Plate Bolt	1/4-20 x 1/2 Place Bolt, Hex		
			AK-007-P	1	Woodruff Key	3/16 x 1-3/4		
			AK-008-P	1	Woodruff Key	1/4 x 7/8		
			AD-005-P	1	Cam Sprocket Dowel	0.3115	Solid	1.125
			AD-397	2	Transmission Dowel	0.5000	Solid	1.000
GENERAL MOTORS								
FKC-2	1985-1986	4.3L (262ci) Chevy V6	AD-927-P	4	Head Dowel	0.3125	Solid	0.565
			AD-1284-P	2	Timing Cover / Oil Pump Dowel	0.2466	Solid	0.630
			AB-001-P	3	Cam Bolt	5/16-18 x 3/4 Hex		
			AK-003-P	1	Woodruff Key	3/16 x 1-13/32		
			AK-002-P	2	Woodruff Key	3/16 x 3/4		
			AV-001-P	1	Bypass Valve	N/A	N/A	N/A
			AD-009-P	2	Transmission Dowel	0.6210	Solid	1.150
			FKC-2A	1987-1994	4.3L (262ci) Chevy V6	AD-927-P	4	Head Dowel
AD-1284-P	2	Timing Cover / Oil Pump Dowel				0.2466	Solid	0.630
AB-001-P	3	Cam Bolt				5/16-18 x 3/4 Hex		
AK-003-P	1	Woodruff Key				3/16 x 1-13/32		
AK-002-P	2	Woodruff Key				3/16 x 3/4		
AV-001-P	1	Bypass Valve				N/A	N/A	N/A
AB-004-P	2	Cam Thrust Plate Bolt				1/4-20 x 1/2 Machine Screw, Torx		
AD-003-P	1	Seal Housing Dowel				0.4445	0.297	0.562
AB-002-P	2	Seal Housing Bolt				1/4-20 x 1-3/4 Machine Screw, Torx		
AB-003-P	2	Seal Housing Bolt				1/4-20 x 7/8 Machine Screw, Torx		
AB-005-P	2	Cam Tray Bolt				5/16-18 x 5/8 Flanged Hex		
AD-009-P	2	Transmission Dowel				0.6210	Solid	1.150
FKC-2B	1992-2001	4.3L (262ci) Chevy V6 w/Balance Shaft	AD-927-P	4	Head Dowel	0.3125	Solid	0.565
			AD-1284-P	2	Timing Cover / Oil Pump Dowel	0.2466	Solid	0.630
			AK-003-P	1	Woodruff Key	3/16 x 1-13/32		
			AK-002-P	2	Woodruff Key	3/16 x 3/4		
			AV-001-P	1	Bypass Valve	N/A	N/A	N/A
			AB-006-P	2	Cam Thrust Plate Bolt	1/4-20 x 5/8 Machine Screw, Torx		
			AD-003-P	1	Seal Housing Dowel	0.4445	0.297	0.562
			AB-002-P	2	Seal Housing Bolt	1/4-20 x 1-3/4 Machine Screw, Torx		
			AB-003-P	2	Seal Housing Bolt	1/4-20 x 7/8 Machine Screw, Torx		
			AB-004-P	2	Balance Shaft Thrust Plate Bolt	1/4-20 x 1/2 Machine Screw, Torx		
			AB-007-P	2	Cam Bolt	5/16-18 x 1-3/8 Cap Screw, Hex		
			ST-045-P	1	Timing Stud	5/16-18 x 1-3/4		
			AN-001-P	1	Timing Stud Nut	5/16-18 Top Lock Nut, Hex		
			AB-005-P	4	Cam Tray Bolt	5/16-18 x 5/8 Flanged Hex		
			AD-009-P	2	Transmission Dowel	0.6210	Solid	1.150
			FKC-1	1957-1986	(262ci-400ci) Chevy SB V8	AD-927-P	4	Head Dowel
AD-1284-P	2	Timing Cover / Oil Pump Dowel				0.2466	Solid	0.630
AB-001-P	3	Cam Bolt				5/16-18 x 3/4 Hex		
AK-001-P	1	Woodruff Key				3/16 x 1-3/8		
AK-002-P	2	Woodruff Key				3/16 x 3/4		
AD-009-P	2	Transmission Dowel				0.6210	Solid	1.150

ENGINE HARDWARE FINISHING KITS

KIT NO.	YEAR	MAKE & APPLICATION	CONTENTS	QTY.	DESCRIPTION	DIMENSION		
						O.D.	I.D.	LENGTH
GENERAL MOTORS (Cont'd)								
FKC-1HP	1957-1986	(262ci-400ci) GM SB V8 (High Performance)	AD-927-P	4	Head Dowel	0.3125	Solid	0.565
			AD-1284-P	4	Timing Cover / Oil Pump Dowel	0.2466	Solid	0.630
			AB-001-P	3	Cam Bolt	5/16-18 x 3/4 Hex		
			AW-013-P	1	Cam Lock Plate	N/A	N/A	N/A
			AB-039-P	2	Oil Filter Adapter Bolts	5/16-18 x 1-1/16		
			AK-001-P	1	Woodruff Key	3/16 x 1-3/8		
			AK-002-P	2	Woodruff Key	3/16 x 3/4		
			AD-023	2	Transmission Dowel	0.6210	Solid	1.550
			FKC-4	1955-1981	(265ci-455ci) Pontiac V8	AD-927-P	4	Head Dowel
AB-031-P	1	Cam Bolt				1/2-20 x 1 Hex		
AW-010-P	1	Cam Bolt Washer				1-3/8 x 1/2 x 3/16 Washer		
AB-001-P	2	Cam Thrust Plate Bolt				5/16-18 x 3/4 Hex		
AK-002-P	1	Woodruff Key				3/16 x 3/4		
AK-001-P	1	Woodruff Key				3/16 x 1-3/8		
		Optional parts not included in kit.						
AD-009-P	2	Transmission Dowel				0.6210	Solid	1.150
FKC-1A	1987-2005	5.0L, 5.7L (305ci, 350ci) Chevy SB V8				AD-927-P	4	Head Dowel
			AD-1284-P	2	Timing Cover / Oil Pump Dowel	0.2466	Solid	0.630
			AB-001-P	3	Cam Bolt	5/16-18 x 3/4 Hex		
			AK-002-P	2	Woodruff Key	3/16 x 3/4		
					SEAL HOUSING			
			AD-003-P	1	Seal Housing Dowel	0.4445	0.297	0.562
			AB-002-P	2	Seal Housing Bolt	1/4-20 x 1-3/4 Machine Screw, Torx		
			AB-003-P	2	Seal Housing Bolt	1/4-20 x 7/8 Machine Screw, Torx		
					ROLLER BLOCK			
			AB-004-P	2	Cam Thrust Plate Bolt	1/4-20 x 1/2 Machine Screw, Torx		
			AB-004-P	2	Water Pump Shaft Thrust Plate Bolt	1/4-20 x 1/2 Machine Screw, Torx		
			AB-005-P	3	Cam Tray Bolt	5/16-18 x 5/8 Flanged Hex		
					Optional parts not included in kit.			
			AD-009-P	2	Transmission Dowel	0.6210	Solid	1.150
FKC-3	1967-1991	(366ci-454ci) Chevy BB V8	AD-8081-P	4	Head Dowel	0.6400	0.500	0.500
			AD-1284-P	2	Timing Cover / Oil Pump Dowel	0.2466	Solid	0.630
			AB-001-P	3	Cam Bolt	5/16-18 x 3/4 Hex		
			AK-002-P	2	Woodruff Key	3/16 x 3/4		
					Optional parts not included in kit.			
			AD-009-P	2	Transmission Dowel	0.6210	Solid	1.150
FKC-3HP	1967-1991	(366ci-454ci) GM BB V8 (High Performance)	AD-8081-P	4	Head Dowel	0.6400	0.500	0.500
			AD-1284-P	4	Timing Cover / Oil Pump Dowel	0.2466	Solid	0.630
			AW-013-P	1	Cam Lock Plate	N/A	N/A	N/A
			AB-039-P	2	Oil Filter Adapter Bolts	5/16-18 x 1-1/16		
			AB-001-P	3	Cam Bolt	5/16-18 x 3/4 Hex		
			AK-002-P	2	Woodruff Key	3/16 x 3/4		
			AD-023	2	Transmission Dowel	0.6210	Solid	1.550

ENGINE HARDWARE PHOTOS



AB-001-P



AB-002-P



AB-003-P



AB-004-P



AB-005-P



AB-006-P



AB-007-P



AB-009-P



AB-010-P



AB-011-P



AB-012-P



AB-013-P



AB-014-P



AB-015-P



AB-016-P



AB-017-P



AB-018-P



AB-019-P



AB-020-P



AB-021-P



AB-022-P



AB-023-P



AB-024-P



AB-026-P

ENGINE HARDWARE PHOTOS



AB-027-P



AB-030-P



AB-031-P



AB-032-P



AB-033-P



AB-034-P



AB-039-P



AB-040-P



AB-042-P



AD-001



AD-002



AD-003-P



AD-004-P



AD-005-P



AD-006-P



AD-007-P



AD-008-P



AD-008A-P



AD-009-P



AD-010-P



AD-011-P



AD-012-P



AD-013



AD-015

ENGINE HARDWARE PHOTOS



AD-016-P

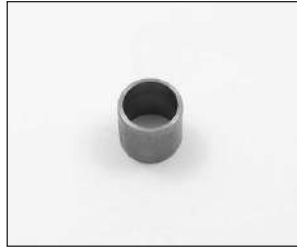

AD-017



AD-018



AD-020

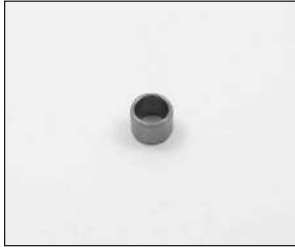

AD-021



AD-022



AD-023

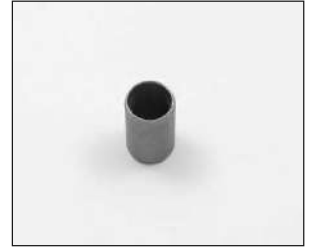

AD-024



AD-025-P



AD-026



AD-027



AD-046



AD-050



AD-076



AD-100



AD-111



AD-0112



AD-0113



AD-148



AD-189



AD-230



AD-242



AD-250



AD-258

ENGINE HARDWARE PHOTOS

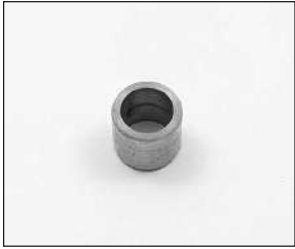

AD-270

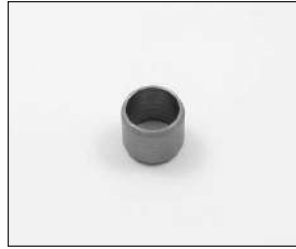

AD-300



AD-326

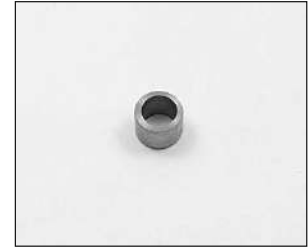

AD-347



AD-352



AD-394



AD-397



AD-397A



AD-400



AD-402



AD-520



AD-521



AD-532



AD-584



AD-600



AD-605



AD-634



AD-635



AD-679



AD-699



AD-842



AD-849



AD-856



AD-927-P

ENGINE HARDWARE PHOTOS



AD-967



AD-1284-P

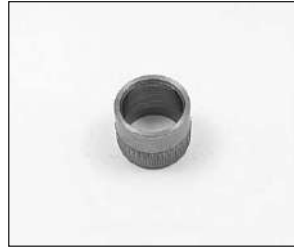

AD-8081-P



AD-8120-P



AD-E7RY



AD-M00

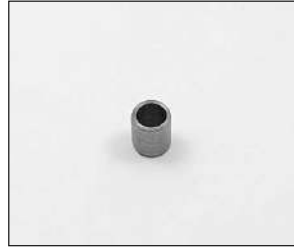

AD-SS



AD-V00



AE-001-P



AE-002-P



AE-003-P



AE-004-P



AK-001-P



AK-002-P



AK-003-P



AK-004-P



AK-005-P



AK-006-P



AK-007-P



AK-008-P



AK-010-P



AK-011-P



AK-012-P



AK-013-P

ENGINE HARDWARE PHOTOS



AK-014-P



AK-015-P



AK-016-P



AK-017-P



AK-018-P

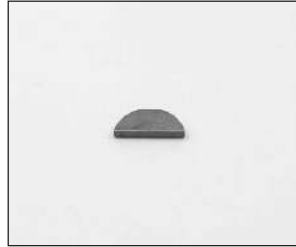

AK-019-P



AK-020-P



AK-022-P



AK-023-P



AK-024-P



AK-025-P



AK-026-P



AK-027-P



AK-030-P



AK-031-P



AN-001-P



AN-002-P



AP-001-P



AP-002-P



AP-003-P



AP-004-P



AP-005-P



AP-006-P



AP-013

ENGINE HARDWARE PHOTOS



AP-014



AP-016-P



AP-017-P



AP-018



AP-019



AS-001-P



AS-002



AV-001-P



AV-280-P



AV-580-PHD



AW-001-P



AW-002-P



AW-003-P



AW-005-P



AW-006-P



AW-007-P



AW-009-P



AW-010-P



AW-011-P



AW-012-P



AW-013-P



CB-001-P



DP-22-P



FD-1-1

ENGINE HARDWARE PHOTOS



FKA-1



FKC-1



FKC-1A



FKC-1HP



FKC-2



FKC-2A



FKC-2B



FKC-3



FKC-3HP



FKC-4



FKF-1



FKF-1A



FKF-2



FKF-3



FKF-3A



FKF-4



FKF-5



FKF-6



FKP-1



FKP-2



FKP-2HP



PIN-1-P



RE200



RE200HP

ENGINE HARDWARE PHOTOS



RE200I



RE250

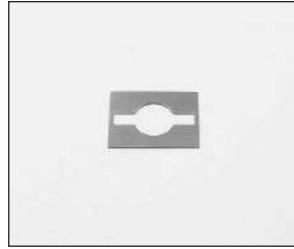

S-006-10-P

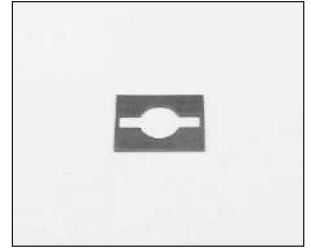

S-006-20-P

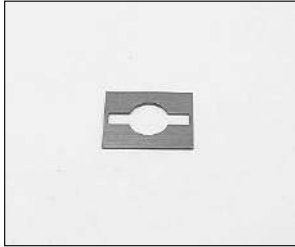

S-006-30-P

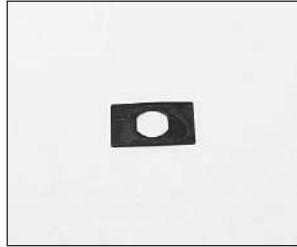

S-100

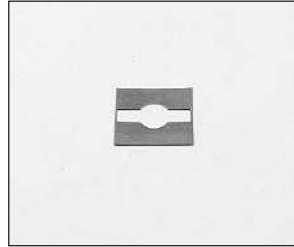

S-220-10-P

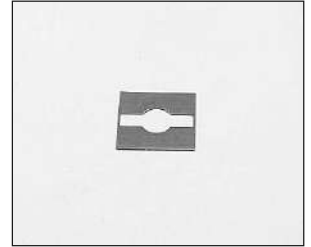

S-220-20-P



SP-230



SP-6265



SP-7488



SPT-1



SPT-2



SPT-3



SPT-4



SPT-5



SR-183



SR-220



SR-318



SR-366



SR-500



SR-502



SR-536



SR-570

ENGINE HARDWARE PHOTOS



SR-626



SR-627



SR-779



SR-809



ST-001-P



ST-002-P



ST-045-P



TC-1-00



TC-1



TC-2



TC-4



TC-5



U140-190



U140-250

TIME TESTED...



QUALITY CAMSHAFT BEARINGS SINCE 1947!



Dura-Bond
A MELLING COMPANY

3200 ARROWHEAD DR., CARSON CITY, NV 89706 • TEL (800) 227.8360 • WWW.DURA-BONDBEARING.COM

TIME TESTED...



VOL. 2



QUALITY CAMSHAFT BEARINGS
SINCE 1947!

Dura-Bond[®]
A MELLING COMPANY

3200 ARROWHEAD DR., CARSON CITY, NV 89706 • TEL (800) 227.8360 • WWW.DURA-BONDBEARING.COM

TIME TESTED...



VOL. 3



Valve Seat Technology Has Changed!

Dura-Bond[®]
A MELLING COMPANY

3200 ARROWHEAD DR., CARSON CITY, NV 89706 · TEL (800) 227-8360 · WWW.DURA-BONDBEARING.COM

TIME TESTED...



QUALITY CAMSHAFT BEARINGS
SINCE 1947!

Dura-Bond[®]
A MELLING COMPANY

VOL. 4

3200 ARROWHEAD DR., CARSON CITY, NV 89706 • TEL (800) 227.8360 • WWW.DURA-BONDBEARING.COM



DISTRIBUTION CENTERS

CALIFORNIA

Don Gross Warehouse
1951 E. 48th Street
Vernon, CA 90058
Phone: 323-582-3800
888-366-4767
Fax: 323-582-2262
sales@dongross.com

NEVADA

Dura-Bond
3200 Arrowhead Drive
Carson City, NV 89706
Phone: 775-883-8998
800-227-8360
Fax: 775-883-9497
www.dura-bondbearing.com

WASHINGTON

Prime Automotive Warehouse
9708 E. Montgomery, Suite B
Spokane, WA 99206
Phone: 509-893-8724
888-893-8724
Fax: 509-893-8748

GEORGIA

Multi-Products Supply
187 Milton Avenue S.E.
Atlanta, GA 30315
Phone: 404-355-1261
800-346-1691
Fax: 404-351-2957
multiproducts@yahoo.com

NORTH CAROLINA

United Engine Parts Distributors
3125 Parkside Drive
Charlotte, NC 28208
Phone: 704-344-0046
877-224-8497
Fax: 704-344-0045
877-346-0045
info@unitedpartsnc.com
www.unitedpartsnc.com

MINNESOTA

Essential Distribution
320 Bryant Avenue N.
Minneapolis, MN 55405
Phone: 612-377-4520
800-489-4520
Fax: 612-377-4522
customerservice@enginepartspro.com
www.enginepartspro.com

TEXAS

Evacam Solutions, LLC
4804 Calvert Street
Dallas, TX 75247
Phone: 214-637-6355
800-888-6958
Fax: 214-637-5513

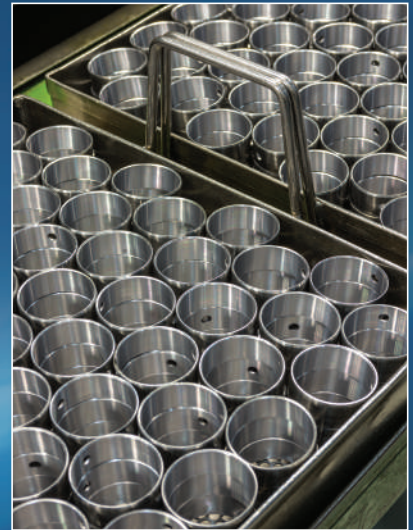
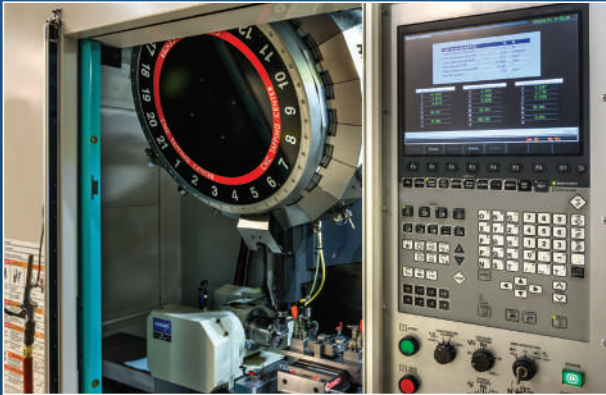
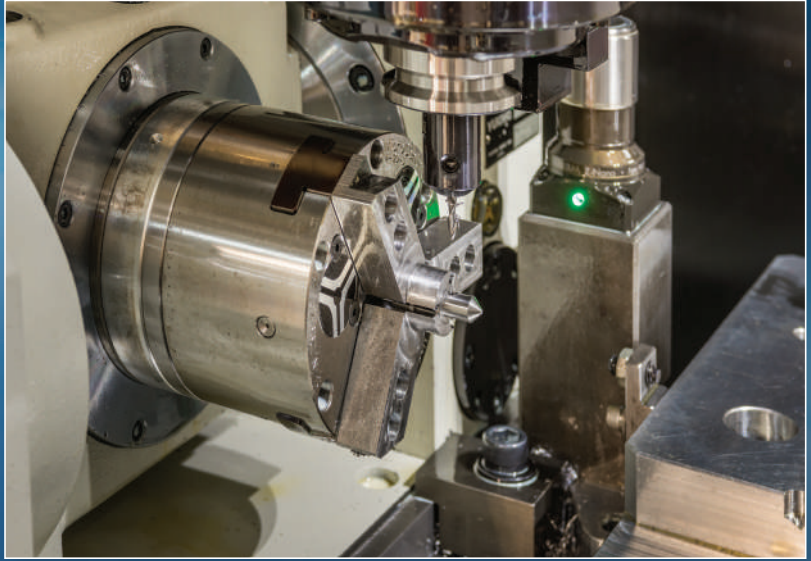

3200 Arrowhead Dr. · Carson City, NV 89706 · TEL 775.883.8998 · 800.227.8360 · FAX 775.883.9497
Visit us online: www.dura-bondbearing.com